



BJC

General Catalogue
Switch ranges



SIEMENS

Introduction

Switch ranges

Surface mounting

Standalone detectors

Assorted material

KNX















Cetact

**Watertight surface-mounting junction boxes
and accessories**

Mounted and connected boxes

Technical information

Order number index

01 - Introduction		6
02 - Iris, Iris plus and Mega		12
03 - Iris IP44		80
04 - Style		86
05 - Miro		118
06 - Viva		154
07 - Coral		180
08 - Sol		202
09 - Rehabitat System		218
10 - Surface mounting		224
11 - Standalone detectors		232
12 - Assorted material		236
13 - KNX		240
14 - Cetact		260
15 - Watertight surface-mounting junction boxes and accessories		270
16 - Mounted and connected boxes		274
17 - Technical information		284
18 - Order number index		318



A long track record, always looking to the future



More than 95 years of experience

BJC was founded in 1924 in a small metal workshop by Buenaventura Josa Camarasa, who gave the name to the BJC brand. For over 95 years since its establishment, BJC has been constantly reinventing and growing, adapting its products to the constantly changing environment. Currently, BJC is a leading company in its sector.

In June 2008, BJC joined Siemens' operational structure, becoming Siemens' production centre for the electrical mechanism series, with the brands: BJC and Siemens, recognised internationally.

We specialise in mechanism series

Over 95 years of experience designing and manufacturing mechanism series with reliability, aesthetics and ergonomics in mind and collaborating in industrial design with A. Ricard since 1975. Our products and components are fully manufactured in Spain and all electronics are manufactured in Germany.

BJC quality, Siemens quality

BJC manufactures in Spain according to SIEMENS' strictest standards of quality. The products manufactured by BJC and SIEMENS are the result of an intense effort in innovation, quality and continuous improvement. Our products do not only comply with international standards, but also with SIEMENS' strictest standards of quality and guidelines. Our factory and providers are audited by the leading certification companies, such as AENOR, VDE, etc., which certify the quality of our processes and customer service procedures.



Our values



People come first

Since our establishment and over these decades, a series of values have remained as BJC's guarantee for success, from product reliability and a quality-centric approach to customer focus. We have always aimed to offer products that make people's everyday lives easier, offering products with a long useful life and to generate value for company employees and customers through our brand.

We know how to work with and for people. Committed to our values. Our products are designed and manufactured to guarantee satisfaction and for comfort of use, for users and those installing them, respecting our environmental policy, which is based on the protection of natural resources and on preventing any form of contamination.

The commitment of each and every person within the company has made our success possible. It is thanks to them that we have grown since our establishment. A team of committed professionals, in constant growth and professional development, allows us to provide a swift response and extremely professional service. All of our customers rate our service as excellent.

We have our own sales network, made up of professionals with extensive experience, who are part of the company and are also in line with BJC's values. They know how to listen to customers and cater to their needs in the different regions in which they operate.

Thanks to our collaborators, we have grown to become a quality and responsible brand. BJC is acknowledged as such in the industry.

Tailored solutions

Choose the option that best suits your needs and your preferred designs and materials. Always with the safety and quality guarantee of BJC and Siemens. More than eight different designs and a wide range of finishes to create the perfect combination. You create, you choose. Endless choices with BJC and Siemens.



Mega



Iris



Coral



Sol



Iris plus

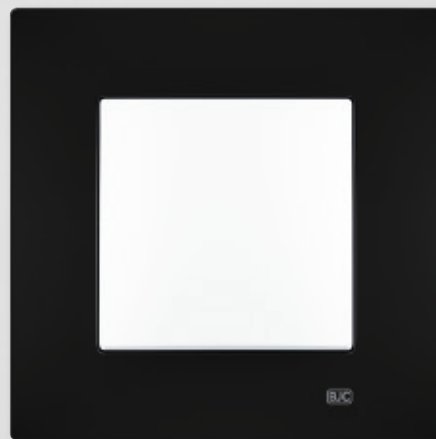

Viva



Style



Miro



BJC

Iris Iris plus Mega

What is your design?

With Iris, Iris plus and Mega, we offer the possibility of choosing the most appealing combination. Three different series for you to express your own style.



Iris



Iris plus



Mega

Iris | Everyone has a different iris colour

The smooth and fluid curved shape of products of the Iris series adapts to different decoration styles.



Iris plus | Harmony in equilibrium

A new straight-line frame that combines perfectly with the curved shape of the Iris switch.



Mega | You know what you want

The well-balanced and smooth curved design of its metallic frames and wide range of finish can cater to the needs of the most demanding customers.



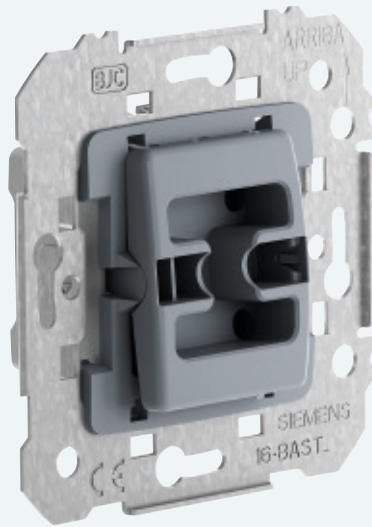

Its structure has an ergonomic design to guarantee easy, quick and comfortable installation. It features a compact mechanism to use all space inside the mounting box and facilitates cable routing. It is designed to ensure proper installation.

- One-way and two-way MEC18 switches rated at 16A are used, allowing many different applications with the same mechanism and reducing the number of items and references that must be stocked.
- Galvanised steel fixing frames with anti-corrosion treatment to ensure durable installation components.
- Fixing frames with upper and lower profiles to facilitate assembly and a rigid position of the mechanism.

The socket outlets feature increased touch protection elements and use standard STAI connectors (open safety screw system), which only require connection and tightening. The screws close with a single operation and have an engraved floating nut which prevents the cable from slipping and guarantees perfect fixture across the whole of the contact surface. The three conductors enter through the top of the socket outlet. They are also screwed on one side of the socket outlet. The outlets, which are supplied separately from the covers, allow terminal connection and fast and safe fixture.

Certifications

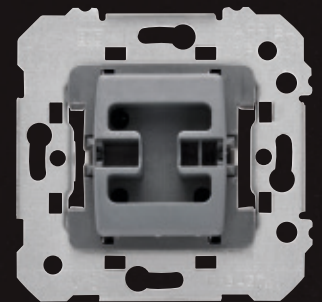

MEC 18

The same mechanism for 5 different designs

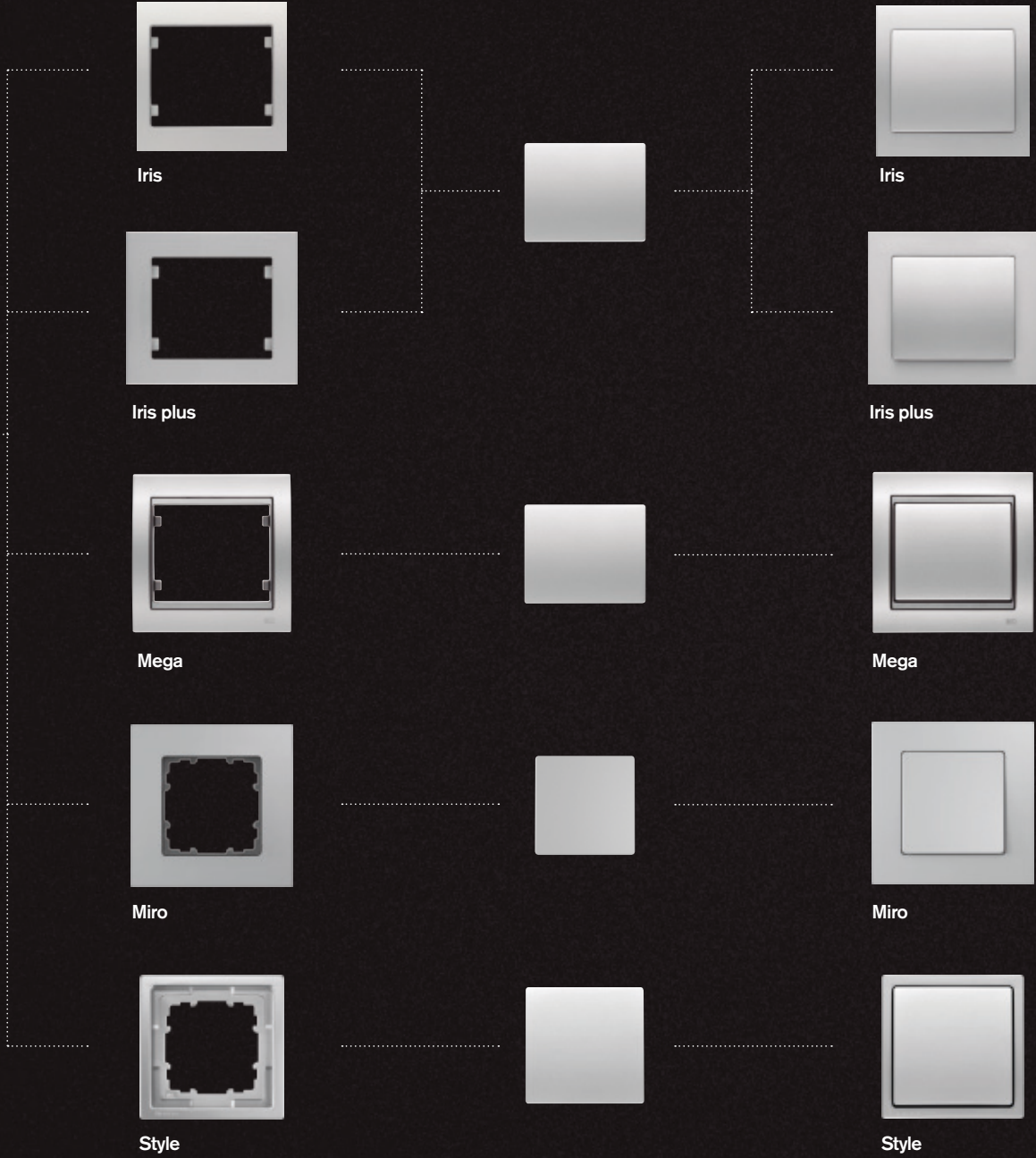

Choose your favourite colour

Iris

Copper for spontaneous, red for passion and white for balance. What colour defines you? We invite you to discover and express your own style with Iris. A series of designs with a wide range of colours, so you can choose the option that best represents you, the colour that goes with your personality.

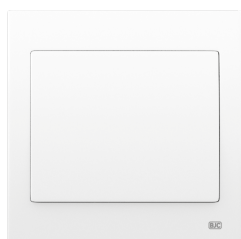

White



Beige



Odyssey Gold



Chocolate



Neptune Steel



Mercury Aluminium



Ruby Red



Jaipur Copper

Everyone has a different iris colour. Now with Iris plus

Iris plus

Because we all have a different way of seeing and interpreting spaces, we present you the new Iris plus. A new option with a straight-line frame, which now joins the hundreds of possibilities of the standard IRIS series.

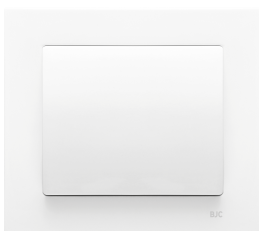

White



Mercury Aluminium



Chocolate



Cosso Anthracite

Because you know what you want

Mega

Gold, aluminium and pearl. Metal brings elegance and singularity, chromatic harmony that blends perfectly in many different spaces. The “Cosso” finish on the switches achieves excellent results in the series and allows an endless number of combinations. All metal frames of the Mega series with a Zamak finish are manufactured with a pressure die-cast method. The colour finishes of the Mega series are treated with the same processes as those used in the automotive industry.

Soft Metal



Fusion Aluminium



Prussian Aluminium



Misty Bronze



Mabe Pearl White



Malt Gold

Textured Metal



Ebony Black



Mocha Brown



Ash Grey



Aluminium



Gold

Pure Metal

Solid Metal

Finishes that combine bright and matt colours



Samoa Brown



Satin White

Iris



Iris plus



We all have our own iris

Its structure has an ergonomic design to guarantee easy, quick and comfortable installation. It features a compact mechanism to use all space inside the mounting box and facilitates cable routing.

- Can be wall mounted.
- Smooth curves.
- Front view with square lines.
- Many different finishes.
- It can be adapted to any decoration needs.
- IP44 flush-mounting solutions, Iris sealed.

Harmony in balance

Attractive for architects, with an appealing square style. Perfect for remodelling and refurbishment work; you only need to change the frame. A good solution for decorators and interior designers for its singular aesthetics. The perfect complement for the Iris series.

- Simple and clean design.
- Straight lines.
- Front view with square lines.
- Flat surface.
- No steps, angles or intermediate frames.
- Urea material.

Mega



You know what you want

There comes a time in life when you don't need any more advice, because you know what you want. You have listened to others and compared many different opinions, but you know what you need best.

- Can be wall mounted, smooth curves.
- Front view with square lines.
- Many different finishes, it can be adapted to any decoration needs + Embellisher.
- Aluminium alloy, metal frame (Zamak).
- Frame with LED lighting.



Urea: the unalterable white

The Iris and Iris plus series are made from Urea, a thermosetting and self-extinguishing resin. Its thermosetting properties offer it great surface hardness, heat resistance and resistance to fading from UV rays and chemical agents. It is also an excellent electrical insulator.



Scratch resistance

Inserts made with Urea are extremely scratch resistant. This is due to the fact that Urea has a much higher surface hardness than other materials.

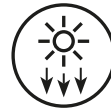

Resistance to sun rays

Being made of Urea, the Iris and Iris plus series are highly resistant to UV light and do not suffer any colour change, compared to other finishes in white present in residential use, which show notable deterioration and discolouration over the years.



Resistance to high temperatures

Urea is a type of resin that does not spread fire and, once moulded, does not soften with heat but rather hardens and does not melt, remaining rigid until its degradation. Its excellent chemical stability, high resistance to deformation, low thermal linear expansion and low flammability make it an extra safe material. Products made from Urea, not only comply with the relevant tests of the IEC 60884-1 and IEC 60669-1 standards at 650°C, but also pass the tests carried out at 850°C (V0 rating according to UL94).





Antibacterial finish

The antibacterial finish of Iris and Iris plus impedes the survival and transmission of microorganisms, which makes it the perfect ally for places where they flourish and where transmission can be high, such as hospitals, residential homes and care centres and the common areas of offices or home-owner's associations.



Resistance to cleaning chemicals and disinfection

One-way switches are elements that are exposed daily to a multitude of germs and viruses as well as disinfectants, solvents and cleaning products. And one of the properties of Urea compared to other thermoplastics is precisely its resistance to degradation due to the continued use of chemicals for the disinfection of germs and viruses such as COVID-19.



Eco-friendly mechanisms

BJC's products do not contain dangerous substances and are, therefore, eco-friendly. The long useful life of Urea avoids the need to change or replace parts, helping to reduce consumption and improve the environment by avoiding waste.

Many different functions

The Iris, Iris plus and Mega series offer a wide range of features to cater to today's needs. Light intensity dimmers, sound controllers and blind rolling up and down mechanisms. Choose the options you need, guaranteeing total comfort and enjoy our solutions' colourful and appealing designs. All functions are featured in the three series.



Motion detector

BJC's motion detector is an automatic light switching system that does not require direct activation to switch lights on or off, and it is always ready to detect the presence of people with its 180° detection angle. This practical and comfortable security solution also cuts costs. Its detection capacity cuts the costs of unnecessary lighting in transit areas and those left on by mistake or by children.



Chargers with double USB

The Schuko® socket with double USB Type A and Type C allows the simultaneous charging of two terminals while maintaining the usability of the socket. Quick and easy installation in a standard flush-mounted box.

- Power Delivery (required by EU by the end of 2024)
- Quick charge
- For standard flush-mounted box.



Multimedia

The multimedia connectors are the perfect solution to prevent exposed wiring in the installation and for the distribution of electronic devices in any type of installation; whether household or commercial. The HDMI, VGA, RJ45, stereo cable and other outputs can provide separate input and output sources, for efficient connections and uncluttered installations.



Socket outlet with voltage indicator

The socket outlet with voltage indicator features a pilot light to indicate that the socket outlet is powered, that voltage is present and that it is operating. The pilot light will switch off in the event of an outage. It is very useful to check that the device is still connected and powered. It has been designed for connecting devices in which an outage can alter vital or sensitive processes, so it is suitable for hospitals, chemical industry, food industry, etc.

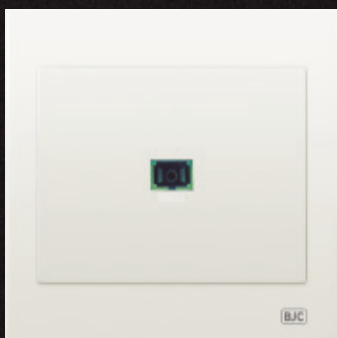

RJ and fibre-optic sockets

The new solutions developed by BJC enable the attachment of an SC/APC optical fibre adapter, thus complying with the new regulations. In this way, the fibre-optic cable can reach the point where it is needed, allowing the router to be easily connected.



Thermostats

The thermostats can be used to control and adjust the temperature in each room. Simple settings to ensure comfort, in a climate control system designed with energy efficiency in mind.



LED beacon light and removable emergency beacon light

The removable emergency beacon light is a practical and functional solution that allows you to use a hand-held lamp when you walk around the house after the electrical circuits have been disconnected by accident due to an outage or breakdown. The beacon light is lit like an emergency lamp, so it can be easily accessed in dark spaces. It can also be removed and taken to a place where the lights can be turned on or to the distribution board.



Key card switches

Hotel key card switches offer practical and profitable solutions. When the key card is inserted, the electrical circuits of the lighting and air-conditioning systems are switched on automatically. When the key card is removed, all connected electrical circuits are switched off automatically. We offer conventional mechanical solutions and timed electronic solutions.



Dimmers

Dimmers are the perfect element create an atmosphere in rooms by adjusting the lighting levels to the desired intensity. The intensity can be increased or decreased. The power and technology of the different lamps requires using specific dimmers, adapted in each case to adjust the power levels. BJC offers a wide range of dimmers, suitable for different lamps and power ratings.



Integration with sound solutions

Integration with the systems of the main sound system manufacturers (Sonelco, Eis, Tez, Sonbe and EGI).



Centralised blind control

By simply pressing a button, this allows you to pull all the blinds in a house or on a floor down, either individually or centrally.

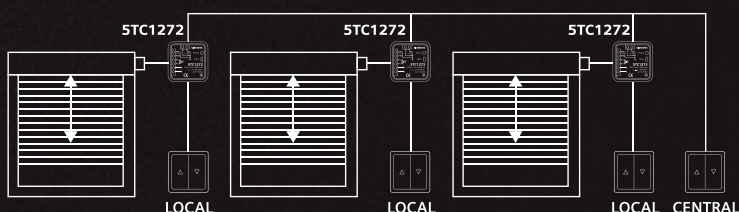

16 A in Mec switches

The switches feature a powerful 16 A device with automatic terminal connection, with an ergonomic design for comfortable, easy and safe handling.

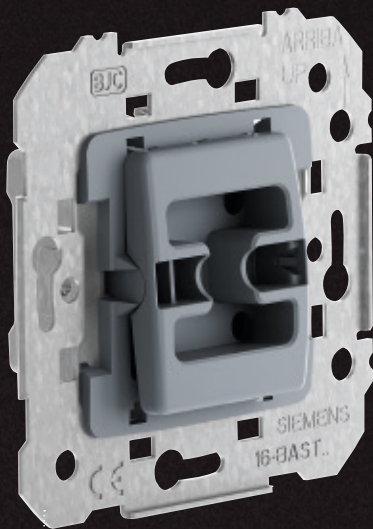





















Mec 18 mechanism,
which can be adapted to
Iris, Iris plus, Mega and
Siemens products for your
comfort.



Table for composing basic functions

Function	Iris			Iris plus			Mega		
	Mechanism	Switch/ Cover	Frame	Mechanism	Switch/ Cover	Frame	Mechanism	Switch/ Cover	Frame
One-way switch	18505	18705*	18001*	18505	18705*	18011*	18505	22705*	22001*
Two-way switch	18506	18705*	18001*	18506	18705*	18011*	18506	22705*	22001*
Intermediate switch	18507	18705*	18001*	18507	18705*	18011*	18507	22705*	22001*
Double one-way switch	18509	18709*	18001*	18509	18709*	18011*	18509	22709*	22001*
Double two-way switch	18510	18709*	18001*	18510	18709*	18011*	18510	22709*	22001*
Bell push-button	18516	18716*	18001*	18516	18716*	18011*	18516	22716*	22001*
Bulb push-button	18516	18717*	18001*	18516	18717*	18011*	18516	22717*	22001*
Dimmer	21549-X	18749*	18001*	21549-X	18749*	18011*	21549-X	22749*	22001*
Schuko® socket	18524	18724*	18001*	18524	18724*	18011*	18524	22724*	22001*
Schuko® + double USB Type A and Type C	18524-USBC	18724-USBC*	18001*	18524-USBC	18724-USBC*	18011*	18524-USBC	22724-USBC*	22001*
TV/FM socket outlet	---	18330*	18001*	---	18330*	18011*	---	22330*	22001*
Adapter for 1 RJ connector	19582-1	19782*	18001*	19582-1	19782*	18011*	19582-1	22782*	22001*
Adapter for 2 RJ connectors	19682-1	19882*	18001*	19682-1	19882*	18011*	19682-1	22783	22001*
Blank cover	---	18033*	18001*	---	18033*	18011*	---	22033*	22001*
Cable output	18534	18734*	18001*	18534	18734*	18011*	18534	22734*	22001*
Buzzer	18536-B	18730*	18001*	18536-B	18730*	18011*	18536-B	22730*	22001*

* For remaining colors add the extension color:

Colour	Iris			Iris plus			Mega		
	Colour	Extension	Color swatch	Colour	Extension	Color swatch	Colour	Extension	Color swatch
	White	-		White	-		Fusion Aluminium	-AF	
	Beige	-A		Mercury Aluminium	-MA		Prussian Aluminium	-AP	
	Odyssey Gold	-OD		Anthracite Cosso	-AC		Malt Gold	-DM	
	Chocolate	-CH		Chocolate	-CH		Pearl White	-BP	
	Mercury Aluminium	-MA					Misty Bronze	-BN	
	Neptune Steel	-AN					Samoa Brown	-MS	
	Ruby Red	-RR					Satin White	-BS	
	Jaipur Cooper	-CJ					Anthracite Cosso	-AC	

The Anthracite Cosso finish in Iris plus corresponds to the Mega series.

Coloured extensions for Mega covers and push-buttons. For frame extensions for the Mega series, see pages 70 to 73.

Iris, Iris plus and Mega



Switches

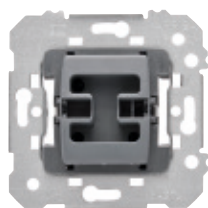

One-way switch	18505
Two-way switch	18506
16 A 250 V~	
Intermediate switch	18507
10 A 250 V~	

Packing 10

* The colors of the Iris plus frames match the colors marked with an asterisk

Iris / Iris plus*

Packing 20	WHITE* 18705-L	BEIGE 18705-AL	ODYSSEY G. 18705-ODL	CHOCOLATE* 18705-CHL
Packing 20	MERC. ALUM.* 18705-MAL	NEP. STEEL 18705-ANL	RUBY RED 18705-RRL	JAIPUR C. 18705-CJL
Packing 20	WHITE* 18705	BEIGE 18705-A	ODYSSEY G. 18705-OD	CHOCOLATE* 18705-CH
Packing 20	MERC. ALUM.* 18705-MA	NEP. STEEL 18705-AN	RUBY RED 18705-RR	JAIPUR C. 18705-CJ

Mega / Iris plus*

Packing 2	FUSION ALUM. 22705-AFL	PRUSS. ALUM. 22705-APL	MALT GOLD 22705-DML	PEARL WHITE 22705-BPL
Packing 2	MISTY BRON. 22705-BNL	SAMOA B. 22705-MSL	SATIN WHITE 22705-BSL	AN. COSSO* 22705-ACL
Packing 2	FUSION ALUM. 22705-AF	PRUSS. ALUM. 22705-AP	MALT GOLD 22705-DM	PEARL WHITE 22705-BP
Packing 2	MISTY BRON. 22705-BN	SAMOA B. 22705-MS	SATIN WHITE 22705-BS	AN. COSSO* 22705-AC

Switches

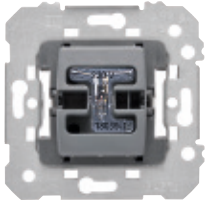

One-way switch with control light 18605
Two-way switch with control light 18606
Two-way switch with indicator light 18506-L
 16 A 250 V~

Packing 10







Neon lamp incorporated in reference
 18506-L

* The colors of the Iris plus frames match the colors marked with an asterisk

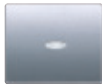
Iris / Iris plus*

				
Packing 20	WHITE* 18705-L	BEIGE 18705-AL	ODYSSEY G. 18705-ODL	CHOCOLATE* 18705-CHL
				
Packing 20	MERC. ALUM.* 18705-MAL	NEP. STEEL 18705-ANL	RUBY RED 18705-RRL	JAIPUR C. 18705-CJL

Mega / Iris plus*

				
Packing 2	FUSION ALUM. 22705-AFL	PRUSS. ALUM. 22705-APL	MALT GOLD 22705-DML	PEARL WHITE 22705-BPL
				
Packing 2	MISTY BRON. 22705-BNL	SAMOA B. 22705-MSL	SATIN WHITE 22705-BSL	AN. COSSO* 22705-ACL

Iris, Iris plus and Mega



Switches

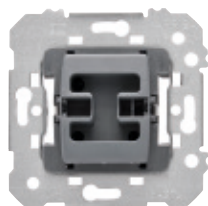

2 pole one-way switch **18508**
 2 pole one-way switch with control light **18608**
 16 A 250 V~

Packing 10

Neon lamp incorporated in reference 18608

* The colors of the Iris plus frames match the colors marked with an asterisk

Iris / Iris plus*

Packing 20	WHITE* 18708-L	BEIGE 18708-AL	ODYSSEY G. 18708-ODL	CHOCOLATE* 18708-CHL
Packing 20	MERC. ALUM.* 18708-MAL	NEP. STEEL 18708-ANL	RUBY RED 18708-RRL	JAIPUR C. 18708-CJL

Packing 20	WHITE* 18708	BEIGE 18708-A	ODYSSEY G. 18708-OD	CHOCOLATE* 18708-CH
Packing 20	MERC. ALUM.* 18708-MA	NEP. STEEL 18708-AN	RUBY RED 18708-RR	JAIPUR C. 18708-CJ

Mega / Iris plus*

Packing 2	FUSION ALUM. 22708-AFL	PRUSS. ALUM. 22708-APL	MALT GOLD 22708-DML	PEARL WHITE 22708-BPL
Packing 2	MISTY BRON. 22708-BNL	SAMOA B. 22708-MSL	SATIN WHITE 22708-BSL	AN. COSSO* 22708-ACL

Packing 2	FUSION ALUM. 22708-AF	PRUSS. ALUM. 22708-AP	MALT GOLD 22708-DM	PEARL WHITE 22708-BP
Packing 2	MISTY BRON. 22708-BN	SAMOA B. 22708-MS	SATIN WHITE 22708-BS	AN. COSSO* 22708-AC

Switches and push-buttons

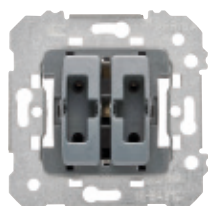

- Double one-way switch** **18509**
- Double two-way switch** **18510**
- 16 A 250 V~
- Double push-button** **18511**
- 10 A 250 V~
- Double push-button with lamp** **18511-L**
- Double push-button normally-closed** **18513**
- 10 A 250 V~

Packing 10

Neon lamp incorporated in reference
18511-L

* The colors of the Iris plus frames match the colors
marked with an asterisk

Iris / Iris plus*

Packing	WHITE*	BEIGE	ODYSSEY G.	CHOCOLATE*
20	18709-L	18709-AL	18709-ODL	18709-CHL
				Packing 2
Packing	MERC. ALUM.*	NEP. STEEL	RUBY RED	JAIPUR C.
20	18709-MAL	18709-ANL	18709-RRL	18709-CJL

Packing	WHITE*	BEIGE	ODYSSEY G.	CHOCOLATE*
20	18709	18709-A	18709-OD	18709-CH
				Packing 2
Packing	MERC. ALUM.*	NEP. STEEL	RUBY RED	JAIPUR C.
20	18709-MA	18709-AN	18709-RR	18709-CJ

Mega / Iris plus*

Packing	FUSION ALUM.	PRUSS. ALUM.	MALT GOLD	PEARL WHITE
2	22709-AFL	22709-APL	22709-DML	22709-BPL
Packing	MISTY BRON.	SAMOA B.	SATIN WHITE	AN. COSSO*
2	22709-BNL	22709-MSL	22709-BSL	22709-ACL

Packing	FUSION ALUM.	PRUSS. ALUM.	MALT GOLD	PEARL WHITE
2	22709-AF	22709-AP	22709-DM	22709-BP
Packing	MISTY BRON.	SAMOA B.	SATIN WHITE	AN. COSSO*
2	22709-BN	22709-MS	22709-BS	22709-AC

Iris, Iris plus and Mega



Inserts

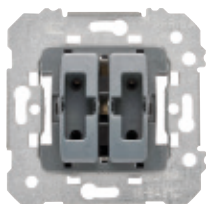

Two way switch + Push-button 18515

16 A + 10 A 250 V~

Packing 10

* The colors of the Iris plus frames match the colors marked with an asterisk

Iris / Iris plus*

Packing 20	WHITE* 18715-L	BEIGE 18715-AL	ODYSSEY G. 18715-ODL	CHOCOLATE* 18715-CHL
				Packing 2
Packing 20	MERC. ALUM.* 18715-MAL	NEP. STEEL 18715-ANL	RUBY RED 18715-RRL	JAIPUR C. 18715-CJL

Packing 20	WHITE* 18715	BEIGE 18715-A	ODYSSEY G. 18715-OD	CHOCOLATE* 18715-CH
				Packing 2
Packing 20	MERC. ALUM.* 18715-MA	NEP. STEEL 18715-AN	RUBY RED 18715-RR	JAIPUR C. 18715-CJ

Mega / Iris plus*

Packing 2	FUSION ALUM. 22715-AFL	PRUSS. ALUM. 22715-APL	MALT GOLD 22715-DML	PEARL WHITE 22715-BPL
Packing 2	MISTY BRON. 22715-BNL	SAMOA B. 22715-MSL	SATIN WHITE 22715-BSL	AN. COSSO* 22715-ACL

Packing 2	FUSION ALUM. 22715-AF	PRUSS. ALUM. 22715-AP	MALT GOLD 22715-DM	PEARL WHITE 22715-BP
Packing 2	MISTY BRON. 22715-BN	SAMOA B. 22715-MS	SATIN WHITE 22715-BS	AN. COSSO* 22715-AC

Push-buttons

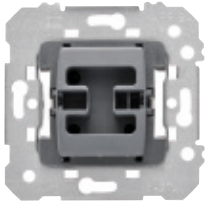

Push-button, normally-open 18516
Push-button, normally-closed 18512
 10 A 250 V~

Packing 10

Note:
 Pictograms can be added
 on request



Bell
 Light

* The colors of the Iris plus frames match the colors marked with an asterisk

Iris / Iris plus*



Packing	WHITE*	BEIGE	ODYSSEY G.	CHOCOLATE*
20	18716-L	18716-AL	18716-ODL	18716-CHL
20	18717-L	18717-AL	18717-ODL	18717-CHL

Packing 2



Packing	MERC. ALUM.*	NEP. STEEL	RUBY RED	JAIPUR C.
20	18716-MAL	18716-ANL	18716-RRL	18716-CJL
20	18717-MAL	18717-ANL	18717-RRL	18717-CJL



Packing	WHITE*	BEIGE	ODYSSEY G.	CHOCOLATE*
20	18716	18716-A	18716-OD	18716-CH
20	18717	18717-A	18717-OD	18717-CH

Packing 2



Packing	MERC. ALUM.*	NEP. STEEL	RUBY RED	JAIPUR C.
20	18716-MA	18716-AN	18716-RR	18716-CJ
20	18717-MA	18717-AN	18717-RR	18717-CJ

Mega / Iris plus*



Packing	FUSION ALUM.	PRUSS. ALUM.	MALT GOLD	PEARL WHITE
2	22716-AFL	22716-APL	22716-DML	22716-BPL
2	22717-AFL	22717-APL	22717-DML	22717-BPL



Packing	MISTY BRON.	SAMOA B.	SATIN WHITE	AN. COSSO*
2	22716-BNL	22716-MSL	22716-BSL	22716-ACL
2	22717-BNL	22717-MSL	22717-BSL	22717-ACL

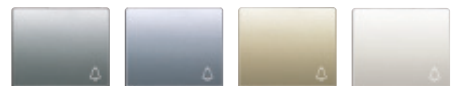

Packing	FUSION ALUM.	PRUSS. ALUM.	MALT GOLD	PEARL WHITE
2	22716-AF	22716-AP	22716-DM	22716-BP
2	22717-AF	22717-AP	22717-DM	22717-BP



Packing	MISTY BRON.	SAMOA B.	SATIN WHITE	AN. COSSO*
2	22716-BN	22716-MS	22716-BS	22716-AC
2	22717-BN	22717-MS	22717-BS	22717-AC

Iris, Iris plus and Mega



Push-buttons

Continued...

Rocker with lighted labelling field

For indication light, add Neon indicator light

Ref. 18039-2AZ

* The colors of the Iris plus frames match the colors marked with an asterisk

Iris / Iris plus*

Packing 20	WHITE* 18714	BEIGE 18714-A	ODYSSEY G. 18714-OD	CHOCOLATE* 18714-CH
Packing 20	MERC. ALUM.* 18714-MA	NEP. STEEL 18714-AN	RUBY RED 18714-RR	JAIPUR C. 18714-CJ

Mega / Iris plus*

Packing 1	FUSION ALUM. 22714-AF	PRUSS. ALUM. 22714-AP	MALT GOLD 22714-DM	PEARL WHITE 22714-BP
Packing 1	MISTY BRON. 22714-BN	SAMOA B. 22714-MS	SATIN WHITE 22714-BS	AN. COSSO* 22714-AC

Indicator lights



Blue LED indicator light **18039-1AZ**

230 V~
Indicator light for single pole and 2 pole one-way switches with control light
Wide rocker

Packing 18039-1AZ = 5



Blue LED indicator light **18039-2AZ**

230 V~
Indicator light for one-way switches, two-way switches, intermediate switches and push-buttons
Wide rocker

Packing 18039-2AZ = 10



Blue LED indicator light **18039-3AZ**

230 V~
Indicator light for all the different kinds of inserts
Narrow rocker

Packing 18039-3AZ = 10



Load for indicator lights **3139** with energy saving and fluorescent lamps

Packing 1

Push-buttons



Push-button with timed switch and indicator light 18599

Power supply voltage 230V~ 50Hz

Consumption: 5VA

Loads:

- Incandescent and halogen 230V:
40 - 400W
- Halogen lamps with ferromagnetic transformer:
50 - 320W
- Halogen lamps with electronic transformer:
40 - 400W
- Motors:
36-100W
- Time adjustable from 30s to 10min

Packing 1

* The colors of the Iris plus frames match the colors marked with an asterisk



Adjustable electronic timer switch 2382

Power supply voltage 230V~ 50Hz

Consumption: 5VA

Loads:

- Incandescent and halogen 230V:
40 - 400W
- Halogen lamps with ferromagnetic transformer:
50 - 320W
- Halogen lamps with electronic transformer:
40 - 400W
- Motors:
36-100W
- Time adjustable from 30s to 10min

Packing 1

Iris / Iris plus*



Packing 20 WHITE* 18717-L BEIGE 18717-AL ODYSSEY G. 18717-ODL CHOCOLATE* 18717-CHL

Packing 2



Packing 20 MERC. ALUM.* 18717-MAL NEP. STEEL 18717-ANL RUBY RED 18717-RRL JAIPUR C. 18717-CJL

Mega / Iris plus*



Packing 2 FUSION ALUM. 22717-AFL PRUSS. ALUM. 22717-APL MALT GOLD 22717-DML PEARL WHITE 22717-BPL



Packing 2 MISTY BRON. 22717-BNL SAMOA B. 22717-MSL SATIN WHITE 22717-BSL AN. COSSO* 22717-ACL

Note:
Pictograms can be added
on request



Inserts for blinds

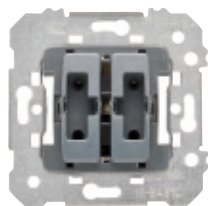

Double push-button for blinds **18565**

With electrical interlocking device

Double switch for blinds **18569**

With electrical and mechanical interlocking device

10 A 250 V~

Packing 10

Double push-button for blinds **18511**

Suitable to connect any blind control device

10 A 250 V~

Packing 10

* The colors of the Iris plus frames match the colors marked with an asterisk



Blinds control to be installed in flush-mounting box **5TC1272**

Blinds controller for 230 V single-phase motors

Max power: 1250 VA

Local or centralised operating

Drive time adjustable from 1 to 120 sec.

Dimensions: 47,5 x 47,5 x 20 mm

Use together with double push button 18511

Packing 1

Iris / Iris plus*

Packing 20	WHITE* 18765	BEIGE 18765-A	ODYSSEY G. 18765-OD	CHOCOLATE* 18765-CH
Packing 20	MERC. ALUM.* 18765-MA	NEP. STEEL 18765-AN	RUBY RED 18765-RR	JAIPUR C. 18765-CJ

Mega / Iris plus*

Packing 2	FUSION ALUM. 22765-AF	PRUSS. ALUM. 22765-AP	MALT GOLD 22765-DM	PEARL WHITE 22765-BP
Packing 2	MISTY BRON. 22765-BN	SAMOA B. 22765-MS	SATIN WHITE 22765-BS	AN. COSSO* 22765-AC



Available with STOP marking. Check availability.

Push-buttons

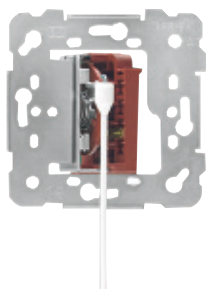

Cord operated push-button 18521

Cord operated two-way switch 18598

10 A 250 V~

Not suitable for claws

Packing 10

* The colors of the Iris plus frames match the colors marked with an asterisk

Iris / Iris plus*



Packing 10	WHITE* 18734	BEIGE 18734-A	ODYSSEY G. 18734-OD	CHOCOLATE* 18734-CH
------------	-----------------	------------------	------------------------	------------------------



Packing 10	MERC. ALUM.* 18734-MA	NEP. STEEL 18734-AN	RUBY RED 18734-RR	JAIPUR C. 18734-CJ
------------	--------------------------	------------------------	----------------------	-----------------------

Mega / Iris plus*



Packing 1	FUSION ALUM. 22734-AF	PRUSS. ALUM. 22734-AP	MALT GOLD 22734-DM	PEARL WHITE 22734-BP
-----------	--------------------------	--------------------------	-----------------------	-------------------------



Packing 1	MISTY BRON. 22734-BN	SAMOA B. 22734-MS	SATIN WHITE 22734-BS	AN. COSSO* 22734-AC
-----------	-------------------------	----------------------	-------------------------	------------------------

Key operated inserts



Two-way switch with key (removable) 18566

Two-way switch with key (not removable) 18567

5 A 250 V~

Intensity: 5 A (cos φ 0.7+1).

Voltage 250 V.

Contacts: 1 Open 1 Closed.

Terminals: silvered for welding.

Supplied with 2 keys.

Packing 1

* The colors of the Iris plus frames match the colors marked with an asterisk

Iris / Iris plus*



Packing 10	WHITE* 18763	BEIGE 18763-A	ODYSSEY G. 18763-OD	CHOCOLATE* 18763-CH
------------	-----------------	------------------	------------------------	------------------------



Packing 10	MERC. ALUM.* 18763-MA	NEP. STEEL 18763-AN	RUBY RED 18763-RR	JAIPUR C. 18763-CJ
------------	--------------------------	------------------------	----------------------	-----------------------

Mega / Iris plus*



Packing 1	FUSION ALUM. 22763-AF	PRUSS. ALUM. 22763-AP	MALT GOLD 22763-DM	PEARL WHITE 22763-BP
-----------	--------------------------	--------------------------	-----------------------	-------------------------



Packing 1	MISTY BRON. 22763-BN	SAMOA B. 22763-MS	SATIN WHITE 22763-BS	AN. COSSO* 22763-AC
-----------	-------------------------	----------------------	-------------------------	------------------------

Iris, Iris plus and Mega



Key card switches

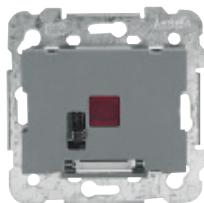

Timed key card switch 18668

125-230 V~ 50/60 Hz
Resistive loads 10 A
Inductive loads 8 A $\cos \varphi = 0.4$
Disconnection delay 1 min
Indicator LED light
Not suitable for claws

Packing 1

May only be mounted in frames
18200- ...1-gang frames

Iris

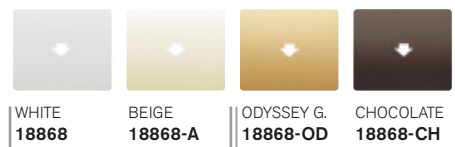

Packing 10

Packing 1

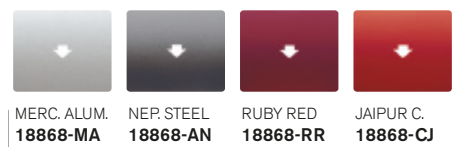

Packing 1

IRIS timed key card switch frame

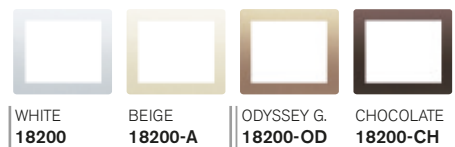

Packing 10

Packing 1

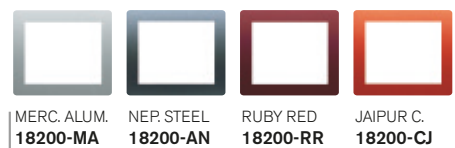

Packing 1

Key card switch with 1 built-in microswitch and indicator light

With built-in neon lamp
250Vac
Resistive load 10A
Inductive load 1,5A

The use of a contactor for inductive loads is recommended

Microswitch for key card switch 2368

Enables to replace or add a microswitch to 22068 key card switch

Packing 10



Iris / Iris plus*



Packing 1

WHITE* 18068 BEIGE 18068-A ODYSSEY G. 18068-OD CHOCOLATE* 18068-CH



Packing 1

MERC. ALUM.* 18068-MA NEP. STEEL 18068-AN RUBY RED 18068-RR JAIPUR C. 18068-CJ

Mega / Iris plus*



Packing 1

FUSION ALUM. 22068-AF PRUSS. ALUM. 22068-AP MALT GOLD 22068-DM PEARL WHITE 22068-BP

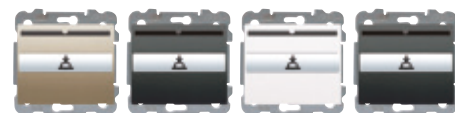

Packing 1

MISTY BRON. 22068-BN SAMOA B. 22068-MS SATIN WHITE 22068-BS AN. COSSÒ* 22068-AC

* The colors of the Iris plus frames match the colors marked with an asterisk

Rotary switches

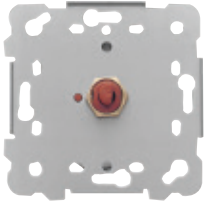

Rotary switch **18596**

16 A 250 V~

Not for use with claws

APPLICATIONS: Switching between fan speeds, fan coils...

Packing 1

4 positions, 3 circuits.

Connection by faston 6.3x0.8 mm.

SEQUENCE OF CONNECTIONS

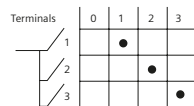

* The colors of the Iris plus frames match the colors marked with an asterisk

Iris / Iris plus*



Packing 10
WHITE* **18796** **BEIGE** **18796-A** **ODYSSEY G.** **18796-OD** **CHOCOLATE*** **18796-CH**



Packing 10
MERC. ALUM.* **18796-MA** **NEP. STEEL** **18796-AN** **RUBY RED** **18796-RR** **JAIPUR C.** **18796-CJ**

Mega / Iris plus*



Packing 1
FUSION ALUM. **22796-AF** **PRUSS. ALUM.** **22796-AP** **MALT GOLD** **22796-DM** **PEARL WHITE** **22796-BP**



Packing 1
MISTY BRON. **22796-BN** **SAMOA B.** **22796-MS** **SATIN WHITE** **22796-BS** **AN. COSSO*** **22796-AC**

Iris, Iris plus and Mega



Dimmers



Two-way dimmer for RL loads (60 to 600 W) **21539-X**
 Two-way dimmer for incandescent (R), direct halogen (R) 60-600 W and halogen 12 V low voltage with ferromagnetic transformer (L) 25-500 VA.
 Fuse T 4 H 250 V
 Switch on / off by pressing
 Screw or claw fixing

Packing 1

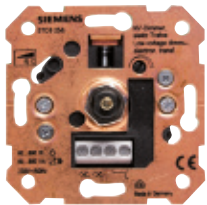

Two-way dimmer for RC loads (60 to 800 W) **21542-X**
 Two-way dimmer for incandescent (R), direct halogen (R) 60-800 W and low voltage halogens with electronic transformer (C) 20 to -800 VA.
 Switch on / off by pressing
 Screw or claw fixing
 Electronic protection against short circuits

Packing 1



Electronic potentiometer for fluorescent lamps **21543-X**
 1 to 10 Vdc
 Potentiometer for fluorescent lamps with adjustable electronic ballast 920 VA, 50 mA (10 VDC)
 Maximum control current: 50 mA. 230 V, 4 A
 Fuse T 4 H 250 V
 Switch on / off by pressing. Screw or claw fixing

Packing 1

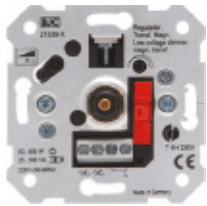

Two-way dimmer for LED lamps 230 Vac **21549-X**
 LED Lamps 6-60 W.
 incandescent, direct halogen (R) 6-120 W halogen 12 V low voltage with ferromagnetic transformer (L) 25-100 VA.
 Switch on / off by pressing
 1.6 Fuse T H 250 V.
 Screw or claw fixing

List of compatibility-tested LED lamps is available at: www.bjc.es/documentacion

Packing 1

Iris / Iris plus*



WHITE* 18749	BEIGE 18749-A	ODYSSEY G. 18749-OD	CHOCOLATE* 18749-CH
------------------------	-------------------------	-------------------------------	-------------------------------

Packing 10

Packing 1

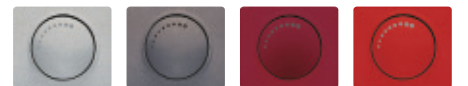

MERC. ALUM.* 18749-MA	NEP. STEEL 18749-AN	RUBY RED 18749-RR	JAIPUR C. 18749-CJ
---------------------------------	-------------------------------	-----------------------------	------------------------------

Packing 1

Mega / Iris plus*



Packing 1	FUSION ALUM. 22749-AF	PRUSS. ALUM. 22749-AP	MALT GOLD 22749-DM	PEARL WHITE 22749-BP
-----------	---------------------------------	---------------------------------	------------------------------	--------------------------------



Packing 1	MISTY BRON. 22749-BN	SAMOA B. 22749-MS	SATIN WHITE 22749-BS	AN. COSSO* 22749-AC
-----------	--------------------------------	-----------------------------	--------------------------------	-------------------------------

* The colors of the Iris plus frames match the colors marked with an asterisk



Blue LED indicator light for dimmers **18039-5AZ**

For Iris and Mega covers 22749 and 18749
 230Vac, 1.1mA

Compatible with the following dimmers:

- 21539-X
- 21542-X
- 21549-X

Note: Do not use with dimmers in two-way switch mode

Packing 1

Dimmers



Universal RLC dimmer

Power supply voltage: 230V~ 50Hz.

Consumption: 3VA.

Loads:

- Incandescent and halogen lamps (230V): 15 - 400W.
- Halogen Lamps with inductive transformer: 20 - 250W.
- Halogen lamps with electronic transformer: 15 - 400W.

Packing 1

2385



Dimmer for LED lamps

Power supply voltage: 230V~ 50/60Hz.

Consumption: 2VA.

Valid for adjustable LED lamps:

- to 230V~: 4-100W
- To 12V~ with adjustable electronic transformer (1 lamp/ transformer): maximum 6 transformers (50W).

Packing 1

2386



Dimmer for LED strip, monochrome (12-48 Vdc)

Power supply voltage: 12 - 48V CC.

Consumption: <12mA.

Maximum Load 8A.

Minimum regulation level: 1% - 60%.

Regulation speed 0% to 100%: 3 - 10 s.

Packing 1

2387



Dimmer for adjustable compact fluorescent lamps

Power supply voltage: 230V~ 50Hz.

Consumption: 3VA.

Load: min.20 - Max.200W.

Packing 1

2388

Load connection

LOAD TYPE								
	Insert Type	230 V halogen lamps	Low voltage halogens 12 V (R) with ferromagnetic transformer (L)	Low voltage halogens lamps with electronic transformer (C)	LED Load 230 V	LED Strips, monochrome (12-48 Vdc)	Dimmable Compact Fluorescent Lamps (CFLs)	Electronic ballast with regulation Input of 1-10V
21539-X	Rotary	60-600 W	25-500 VA	NO	NO	NO	NO	NO
21542-X	Rotary	60-800 W	NO	60-800 VA	NO	NO	NO	NO
21543-X	Rotary	NO	NO	NO	NO	NO	NO	920 VA 50 mA (10 V _{DC})
21549-X	Rotary	6-120 W	25-100 VA	NO	6-60 W	NO	NO	NO
2385	By push-button	15-400 W	20-250 VA	15-400 VA	NO	NO	NO	NO
2386	By push-button	NO	NO	4-300 W	4-100 W	NO	NO	NO
2387 *	By push-button	NO	NO	NO	NO	Maximum 8 A	NO	NO
2388	By push-button	NO	NO	NO	NO	NO	20 W - 200 W	NO

* 2387. The dimmer must be installed along with the 230Vac 12-48Vdc transformer that carries the LED strip. A list of compatibility-tested LED lamps is available at www.bj.es/documentation

Iris, Iris plus and Mega



Socket outlets with increased touch protection

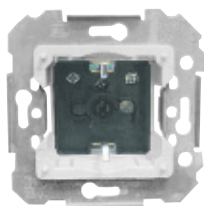

Schuko® socket outlet with increased touch protection 18524
Screwed terminals 16 A 250 V~

Packing 10

* The colors of the Iris plus frames match the colors marked with an asterisk

Iris / Iris plus*



Packing 10	WHITE* 18724	BEIGE 18724-A	ODYSSEY G. 18724-OD	CHOCOLATE* 18724-CH
------------	------------------------	-------------------------	-------------------------------	-------------------------------

Packing 1

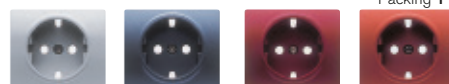

Packing 10	MERC. ALUM.* 18724-MA	NEP. STEEL 18724-AN	RUBY RED 18724-RR	JAIPUR C. 18724-CJ
------------	---------------------------------	-------------------------------	-----------------------------	------------------------------

Mega / Iris plus*



Packing 1	FUSION ALUM. 22724-AF	PRUSS. ALUM. 22724-AP	MALT GOLD 22724-DM	PEARL WHITE 22724-BP
-----------	---------------------------------	---------------------------------	------------------------------	--------------------------------



Packing 1	MISTY BRON. 22724-BN	SAMOA B. 22724-MS	SATIN WHITE 22724-BS	AN. COSSO* 22724-AC
-----------	--------------------------------	-----------------------------	--------------------------------	-------------------------------

Hinged lid for Schuko® socket outlet

* The colors of the Iris plus frames match the colors marked with an asterisk

Iris / Iris plus*



Packing 10	WHITE* 18813	BEIGE 18813-A	ODYSSEY G. 18813-OD	CHOCOLATE* 18813-CH
------------	------------------------	-------------------------	-------------------------------	-------------------------------

Packing 1



Packing 10	MERC. ALUM.* 18813-MA	NEP. STEEL 18813-AN	RUBY RED 18813-RR	JAIPUR C. 18813-CJ
------------	---------------------------------	-------------------------------	-----------------------------	------------------------------

Mega / Iris plus*



Packing 1	FUSION ALUM. 22813-AF	PRUSS. ALUM. 22813-AP	MALT GOLD 22813-DM	PEARL WHITE 22813-BP
-----------	---------------------------------	---------------------------------	------------------------------	--------------------------------



Packing 1	MISTY BRON. 22813-BN	SAMOA B. 22813-MS	SATIN WHITE 22813-BS	AN. COSSO* 22813-AC
-----------	--------------------------------	-----------------------------	--------------------------------	-------------------------------

Identification for special circuits



Packing 10
18724-R

Socket outlets with increased touch protection



Erp

Schuko® socket outlet **18524-USBC** **NEW**
2P+E with double USB
type A and type C charger with
fast charging with increased
touch protection

Schuko® socket:
 - 230Vac 50Hz, 16A
 - Screwless terminal
 Double USB charger:
 - 1 USB Type A socket and 1 USB Type C socket
 - Maximum power: 20W
 - Quick charge Power Delivery USB C: 5V/3A; 9V/2.22A; 12V/1.67A
 - Quick charge USB A fast charging: 5V/3A; 9V/2.22A; 12V/1.67A
 - Normal charging:
 · 5V/3.4A when using USB A and USB C at the same time
 · 5V/2.4A when using USB A or USB C individually
 - Short circuit protection
 - Temperature protection

According to UNE 20315-1-1/1-2 and EN 62368-1 standards

Packing 1

* The colors of the Iris plus frames match the colors marked with an asterisk

Iris / Iris plus*



Packing 1
 WHITE*
18724-USBC **NEW**



ODYSSEY G.
18724-USBC-OD **NEW**



CHOCOLATE*
18724-USBC-CH **NEW**



Packing 1
 MERC. ALUM.*
18724-USBC-MA **NEW**



NEP. STEEL
18724-USBC-AN **NEW**

Mega / Iris plus*



Packing 1
 FUSION ALUM.
22724-USBC-AF **NEW**



PRUSS. ALUM.
22724-USBC-AP **NEW**



MALT GOLD
22724-USBC-DM **NEW**



PEARL WHITE
22724-USBC-BP **NEW**



Packing 1
 MISTY BRON.
22724-USBC-BN **NEW**



SAMOA B.
22724-USBC-MS **NEW**



SATIN WHITE
22724-USBC-BS **NEW**



AN. COSSO*
22724-USBC-AC **NEW**

Schuko® socket outlet with increased touch protection (with BJC Iris frame built-in)
 16 A 250 V~

Packing 10



WHITE
18024



BEIGE
18024-A

25A socket outlets



2P+E socket outlet
 25 A 250 V~ 85 x 85 x 35 mm
 Accepts any 25 A 2P+E plug
 250 V~ S/UNE 20315
 Terminals hold cables up to a 10 mm²
 The box recommended for this socket outlet is Ref. 2373-I

Packing 5

White
2225

25A Plugs



2P+E plug
 25 A 250 V~
 Packing 10

White
2224-B

Socket outlets

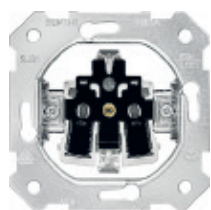

Schuko® socket outlet with screw-less terminals
With claws 5UB1101-5B
Without claws 5UB1101-5KK

Screwed terminals
 16 A 250 V~

Packing 10

Cover with increased touch protection

* The colors of the Iris plus frames match the colors marked with an asterisk

Cover with increased touch protection

Cover with indicator light and increased touch protection (includes indicator light for Schuko® socket outlet 5TG7 304)

Cover with indicator light and increased touch protection (includes indicator light for Schuko® socket outlet 5TG7 304)

Iris / Iris plus*



Packing	WHITE*	BEIGE	ODYSSEY G.	MERC. ALUM.*	NEP. STEEL
10	18732	18732-A	18732-OD	18732-MA	18732-AN

Mega / Iris plus*



Packing	FUSION ALUM.	PRUSS. ALUM.	MALT GOLD	PEARL WHITE
1	22732-AF	22732-AP	22732-DM	22732-BP



Packing	MISTY BRON.	SAMOA B.	SATIN WHITE	AN. COSSO*
1	22732-BN	22732-MS	22732-BS	22732-AC

Iris / Iris plus*



Packing	WHITE*	BEIGE	ODYSSEY G.	MERC. ALUM.*	NEP. STEEL
1	18732-L	18732-AL	18732-ODL	18732-MAL	18732-ANL

Mega / Iris plus*



Packing	FUSION ALUM.	PRUSS. ALUM.	MALT GOLD	PEARL WHITE
1	22732-AFL	22732-APL	22732-DML	22732-BPL



Packing	MISTY BRON.	SAMOA B.	SATIN WHITE	AN. COSSO*
1	22732-BNL	22732-MSL	22732-BSL	22732-ACL

Socket outlets with increased touch protection

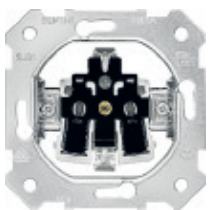

Schuko® socket outlet with screw-less terminals
With claws 5UB1101-5B
Without claws 5UB1101-5KK

Screwed terminals
 16 A 250 V~

Packing 10

Hinged lid with increased touch protection

* The colors of the Iris plus frames match the colors marked with an asterisk

Hinged lid with increased touch protection

Iris / Iris plus*



Packing	WHITE*	BEIGE	ODYSSEY G.	MERC. ALUM.*	NEP. STEEL
1	18814	18814-A	18814-OD	18814-MA	18814-AN

Mega / Iris plus*

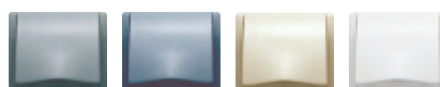

Packing	FUSION ALUM.	PRUSS. ALUM.	MALT GOLD	PEARL WHITE
1	22814-AF	22814-AP	22814-DM	22814-BP



Packing	MISTY BRON.	SAMOA B.	SATIN WHITE	AN. COSSO*
1	22814-BN	22814-MS	22814-BS	22814-AC

Socket outlets (French standard)

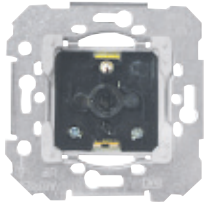

2 pole with earth pin socket outlet 18572
(French/Belgian standard)

With increased touch protection
Screwed terminals 16 A 250 V~

Packing 10

* The colors of the Iris plus frames match the colors marked with an asterisk

Iris / Iris plus*

Packing 10	WHITE* 18772	BEIGE 18772-A	ODYSSEY G. 18772-OD	CHOCOLATE* 18772-CH
Packing 10	MERC. ALUM.* 18772-MA	NEP. STEEL 18772-AN	RUBY RED 18772-RR	JAIPUR C. 18772-CJ

Mega / Iris plus*

Packing 1	FUSION ALUM. 22772-AF	PRUSS. ALUM. 22772-AP	MALT GOLD 22772-DM	PEARL WHITE 22772-BP
Packing 1	MISTY BRON. 22772-BN	SAMOA B. 22772-MS	SATIN WHITE 22772-BS	AN. COSSO* 22772-AC

French socket with double USB charger



Erp

French socket outlet 2P+E with double USB type A and type C charger with fast charging **5UB1657-4** **NEW**

with increased touch protection

Plug socket:

- 230Vac 50Hz, 16A
- Screwless terminal

Double USB charger:

- 1 USB Type A socket and 1 USB Type C socket
- Maximum power: 20W
- Quick charge Power Delivery USB C: 5V/3A; 9V/2.22A; 12V/1.67A
- Quick charge USB A fast charging: 5V/3A; 9V/2.22A; 12V/1.67A
- Normal charging:
 - 5V/3.4A when using USB A and USB C at the same time
 - 5V/2.4A when using USB A or USB C individually
- Short circuit protection
- Temperature protection

According to UNE 20315-1-1/1-2 and EN 62368-1 standards

Packing 1

Check availability.

* The colors of the Iris plus frames match the colors marked with an asterisk

Iris / Iris plus*

Packing 10	WHITE* 18772-USBC NEW	ODYSSEY G. 18772-USBC-OD NEW	CHOCOLATE* 18772-USBC-CH NEW
Packing 10	MERC. ALUM.* 18772-USBC-MA NEW	NEP. STEEL 18772-USBC-AN NEW	

Mega / Iris plus*

Packing 10	FUSION ALUM. 22772-USBC-AF NEW	PRUSS. ALUM. 22772-USBC-AP NEW	MALT GOLD 22772-USBC-DM NEW	PEARL WHITE 22772-USBC-BP NEW
Packing 10	MISTY BRON. 22772-USBC-BN NEW	SAMOA B. 22772-USBC-MS NEW	SATIN WHITE 22772-USBC-BS NEW	AN. COSSO* 22772-USBC-AC NEW

Other inserts



Cable output **18534**

With terminal 3 x 1.5 mm²
Maximum Ø 10 mm cable
Not suitable for claws

Packing 10

* The colors of the Iris plus frames match the colors marked with an asterisk

Iris / Iris plus*

Packing 10	WHITE* 18734	BEIGE 18734-A	ODYSSEY G. 18734-OD	CHOCOLATE* 18734-CH
Packing 10	MERC. ALUM.* 18734-MA	NEP. STEEL 18734-AN	RUBY RED 18734-RR	JAIPUR C. 18734-CJ

Mega / Iris plus*

Packing 1	FUSION ALUM. 22734-AF	PRUSS. ALUM. 22734-AP	MALT GOLD 22734-DM	PEARL WHITE 22734-BP
Packing 1	MISTY BRON. 22734-BN	SAMOA B. 22734-MS	SATIN WHITE 22734-BS	AN. COSSO* 22734-AC



Pilot light **18630**

Works with E10 3W 230V bulb or equivalent LED, the bulb is not supplied with the equipment.

Packing 10

Not suitable for permanent marking if LED lamp (not supplied) is not used.

Red lens 	Amber lens 	Glass lens 	Green lens
18630-R Packing 10	18630-AB Packing 10	18630-C Packing 10	18630-V Packing 10

Not suitable for claws
Covers for buzzer and pilot light

* The colors of the Iris plus frames match the colors marked with an asterisk

Iris / Iris plus*

Packing 10	WHITE* 18730	BEIGE 18730-A	ODYSSEY G. 18730-OD	CHOCOLATE* 18730-CH
Packing 10	MERC. ALUM.* 18730-MA	NEP. STEEL 18730-AN	RUBY RED 18730-RR	JAIPUR C. 18730-CJ

Mega / Iris plus*

Packing 1	FUSION ALUM. 22730-AF	PRUSS. ALUM. 22730-AP	MALT GOLD 22730-DM	PEARL WHITE 22730-BP
Packing 1	MISTY BRON. 22730-BN	SAMOA B. 22730-MS	SATIN WHITE 22730-BS	AN. COSSO* 22730-AC

Other inserts



Buzzer with tone regulation

White 18536-B

Black 18536

Beige 18536-A

230 V~ 50 Hz
Intermittent Use



Packing 10

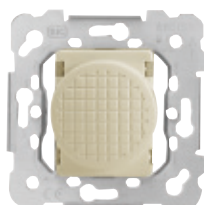

Iris / Iris plus*



Packing 10	WHITE* 18730	BEIGE 18730-A	ODYSSEY G. 18730-OD	CHOCOLATE* 18730-CH
------------	-----------------	------------------	------------------------	------------------------



Packing 10	MERC. ALUM.* 18730-MA	NEP. STEEL 18730-AN	RUBY RED 18730-RR	JAIPUR C. 18730-CJ
------------	--------------------------	------------------------	----------------------	-----------------------

Mega / Iris plus*



Packing 1	FUSION ALUM. 22730-AF	PRUSS. ALUM. 22730-AP	MALT GOLD 22730-DM	PEARL WHITE 22730-BP
-----------	--------------------------	--------------------------	-----------------------	-------------------------



Packing 1	MISTY BRON. 22730-BN	SAMOA B. 22730-MS	SATIN WHITE 22730-BS	AN. COSSO* 22730-AC
-----------	-------------------------	----------------------	-------------------------	------------------------

* The colors of the Iris plus frames match the colors marked with an asterisk

Other inserts



LED beacon light
Cool white, 5000K 18531
Warm white, 3000K 18531-4
 230 Vac 0,4 W
 5 Lm
 (Other colours available on request)

Packing 1

* The colors of the Iris plus frames match the colors marked with an asterisk

Iris / Iris plus*

Packing 10	WHITE* 18742	BEIGE 18742-A	ODYSSEY G. 18742-OD	CHOCOLATE* 18742-CH Packing 1
Packing 10	MERC. ALUM.* 18742-MA	NEP. STEEL 18742-AN	RUBY RED 18742-RR	JAIPUR C. 18742-CJ

Mega / Iris plus*

Packing 1	FUSION ALUM. 22742-AF	PRUSS. ALUM. 22742-AP	MALT GOLD 22742-DM	PEARL WHITE 22742-BP
Packing 1	MISTY BRON. 22742-BN	SAMOA B. 22742-MS	SATIN WHITE 22742-BS	AN. COSSO* 22742-AC

Emergency beacon light



Removable emergency beacon light 18584
 Emergency lighting for hallways, classrooms... in the event of a power failure. The beacon light can be removed to be used as a torch (removal can be prevented by means of a screw, also supplied).
 Power supply 230 V~ 50 ÷ 60 Hz
 Battery autonomy ≈ 3 h ± 15
 Battery recharge time ≈ 12 h

Packing 1

* The colors of the Iris plus frames match the colors marked with an asterisk

Iris / Iris plus*

Packing 10	WHITE* 18784	BEIGE 18784-A	ODYSSEY G. 18784-OD	CHOCOLATE* 18784-CH Packing 1
Packing 10	MERC. ALUM.* 18784-MA	NEP. STEEL 18784-AN	RUBY RED 18784-RR	JAIPUR C. 18784-CJ

Mega / Iris plus*

Packing 1	FUSION ALUM. 22784-AF	PRUSS. ALUM. 22784-AP	MALT GOLD 22784-DM	PEARL WHITE 22784-BP
Packing 1	MISTY BRON. 22784-BN	SAMOA B. 22784-MS	SATIN WHITE 22784-BS	AN. COSSO* 22784-AC

TV-FM-R/TV-SAT Socket outlets

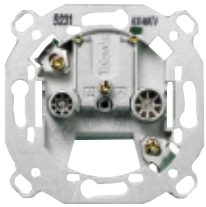

TV-FM socket outlet
Series 2-10 2932
Final outlet 2933
Individual installation 2934
 (Manufacturer TELEVÉS)

Packing 10

TV-FM socket outlets are according to UNE 20523 and CEI 169-2 standards

* The colors of the Iris plus frames match the colors marked with an asterisk

Iris / Iris plus*

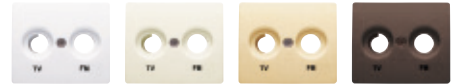

Packing 20	WHITE* 18330	BEIGE 18330-A	ODYSSEY G. 18330-OD	CHOCOLATE* 18330-CH
------------	------------------------	-------------------------	-------------------------------	-------------------------------



Packing 20	MERC. ALUM.* 18330-MA	NEP. STEEL 18330-AN	RUBY RED 18330-RR	JAIPUR C. 18330-CJ
------------	---------------------------------	-------------------------------	-----------------------------	------------------------------

Mega / Iris plus*



Packing 2	FUSION ALUM. 22330-AF	PRUSS. ALUM. 22330-AP	MALT GOLD 22330-DM	PEARL WHITE 22330-BP
-----------	---------------------------------	---------------------------------	------------------------------	--------------------------------



Packing 2	MISTY BRON. 22330-BN	SAMOA B. 22330-MS	SATIN WHITE 22330-BS	AN. COSSO* 22330-AC
-----------	--------------------------------	-----------------------------	--------------------------------	-------------------------------

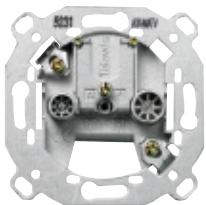

R/TV SAT socket with 2 outlets
Series 6-12 2921
Series 2-5 2922
Final outlet 2923
Individual installation 2924
 (Manufacturer TELEVÉS)

Packing 10

R/TV-SAT socket outlets are according to UNE 20523 and CEI 169-2 standards

* The colors of the Iris plus frames match the colors marked with an asterisk

Iris / Iris plus*



Packing 20	WHITE* 18320	BEIGE 18320-A	ODYSSEY G. 18320-OD	CHOCOLATE* 18320-CH
------------	------------------------	-------------------------	-------------------------------	-------------------------------



Packing 20	MERC. ALUM.* 18320-MA	NEP. STEEL 18320-AN	RUBY RED 18320-RR	JAIPUR C. 18320-CJ
------------	---------------------------------	-------------------------------	-----------------------------	------------------------------

Mega / Iris plus*



Packing 2	FUSION ALUM. 22320-AF	PRUSS. ALUM. 22320-AP	MALT GOLD 22320-DM	PEARL WHITE 22320-BP
-----------	---------------------------------	---------------------------------	------------------------------	--------------------------------

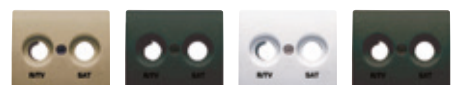

Packing 2	MISTY BRON. 22320-BN	SAMOA B. 22320-MS	SATIN WHITE 22320-BS	AN. COSSO* 22320-AC
-----------	--------------------------------	-----------------------------	--------------------------------	-------------------------------

Iris, Iris plus and Mega



TV-FM-R/TV-SAT socket outlets



R/TV-SAT socket with 3 outlets
Individual socket installation 2918
 (Manufacturer TELEVÉS)

Packing 1

R/TV-SAT sockets outlets conform to
 UNE-20523 and CEI 169-2 standards

* The colors of the Iris plus frames match the colors
 marked with an asterisk

Iris / Iris plus*

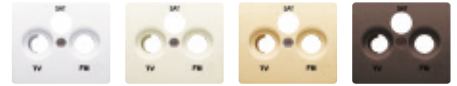

Packing 2	WHITE* 18341	BEIGE 18341-A	ODYSSEY G. 18341-OD	CHOCOLATE* 18341-CH
--------------	------------------------	-------------------------	-------------------------------	-------------------------------



Packing 2	MERC. ALUM.* 18341-MA	NEP. STEEL 18341-AN	RUBY RED 18341-RR	JAIPUR C. 18341-CJ
--------------	---------------------------------	-------------------------------	-----------------------------	------------------------------

Mega / Iris plus*



Packing 2	FUSION ALUM. 22341-AF	PRUSS. ALUM. 22341-AP	MALT GOLD 22341-DM	PEARL WHITE 22341-BP
--------------	---------------------------------	---------------------------------	------------------------------	--------------------------------



Packing 2	MISTY BRON. 22341-BN	SAMOA B. 22341-MS	SATIN WHITE 22341-BS	AN. COSSO* 22341-AC
--------------	--------------------------------	-----------------------------	--------------------------------	-------------------------------

RJ type connectivity terminals

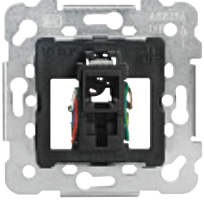

Adapter with RJ11 connector 18482
Screwed terminals

Packing 10

* The colors of the Iris plus frames match the colors marked with an asterisk

Iris / Iris plus*

Packing 10	WHITE* 18882	BEIGE 18882-A	ODYSSEY G. 18882-OD	CHOCOLATE* 18882-CH
Packing 10	MERC. ALUM.* 18882-MA	NEP. STEEL 18882-AN	RUBY RED 18882-RR	JAIPUR C. 18882-CJ

Mega / Iris plus*

Packing 1	FUSION ALUM. 22882-AF	PRUSS. ALUM. 22882-AP	MALT GOLD 22882-DM	PEARL WHITE 22882-BP
Packing 1	MISTY BRON. 22882-BN	SAMOA B. 22882-MS	SATIN WHITE 22882-BS	AN. COSSO* 22882-AC

Iris, Iris plus and Mega



RJ type connectivity terminals

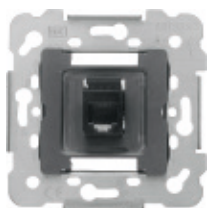

Adapter with RJ11 connector 19582

Tool-less connection

Packing 10



Adapter with RJ45 connector 19595
Cat 5E (ISO 8877)

Packing 10

Adapter with RJ45 connector 18586
Cat 6

Tool-less connection

Packing 10

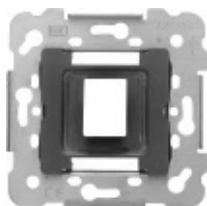

Adapter for 19582-1
1 RJ45/RJ11 connector
(AMP, ITT, etc.)

Packing 10



Keystone RJ45 3186-B
connector Cat 6

Cat. 6

White

Tool-less connection

Packing 25

* The colors of the Iris plus frames match the colors marked with an asterisk

Iris / Iris plus*



Packing 10 WHITE* 19782 BEIGE 19782-A ODYSSEY G. 19782-OD CHOCOLATE* 19782-CH

Packing 2



Packing 10 MERC. ALUM.* 19782-MA NEP. STEEL 19782-AN RUBY RED 19782-RR JAIPUR C. 19782-CJ

Mega / Iris plus*



Packing 2 FUSION ALUM. 22782-AF PRUSS. ALUM. 22782-AP MALT GOLD 22782-DM PEARL WHITE 22782-BP



Packing 2 MISTY BRON. 22782-BN SAMOA B. 22782-MS SATIN WHITE 22782-BS AN. COSSO* 22782-AC

Iris / Iris plus*

Covers with labelling field



Packing 10 WHITE* 19783 BEIGE 19783-A ODYSSEY G. 19783-OD CHOCOLATE* 19783-CH

Packing 2



Packing 10 MERC. ALUM.* 19783-MA NEP. STEEL 19783-AN RUBY RED 19783-RR JAIPUR C. 19783-CJ

Mega / Iris plus*

Covers with labelling field



Packing 2 FUSION ALUM. 22883-AF PRUSS. ALUM. 22883-AP MALT GOLD 22883-DM PEARL WHITE 22883-BP



Packing 2 MISTY BRON. 22883-BN SAMOA B. 22883-MS SATIN WHITE 22883-BS AN. COSSO* 22883-AC

RJ type connectivity terminals

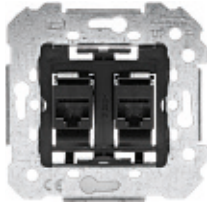

**Adapter with
2 RJ45 connectors Cat 6
female 8 pin**
Tool-less connection

Packing 1

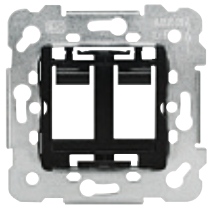

**Adapter for
2 RJ45/RJ11 connectors
female 8 pin**

Packing 10



**Keystone RJ45
connector Cat 6**
Cat. 6
White
Tool-less connection

Packing 25

* The colors of the Iris plus frames match the colors marked with an asterisk

Iris / Iris plus*



Packing 10
WHITE* 19882
BEIGE 19882-A
ODYSSEY G. 19882-OD
CHOCOLATE* 19882-CH

Packing 2



Packing 10
MERC. ALUM.* 19882-MA
NEP. STEEL 19882-AN
RUBY RED 19882-RR
JAIPUR C. 19882-CJ

Mega / Iris plus*



Packing 2
FUSION ALUM. 22783-AF
PRUSS. ALUM. 22783-AP
MALT GOLD 22783-DM
PEARL WHITE 22783-BP



Packing 2
MISTY BRON. 22783-BN
SAMOA B. 22783-MS
SATIN WHITE 22783-BS
AN. COSSO* 22783-AC

Iris / Iris plus*

Covers with
labelling field



Packing 10
WHITE* 19883
BEIGE 19883-A
ODYSSEY G. 19883-OD
CHOCOLATE* 19883-CH

Packing 2



Packing 10
MERC. ALUM.* 19883-MA
NEP. STEEL 19883-AN
RUBY RED 19883-RR
JAIPUR C. 19883-CJ

Mega / Iris plus*

Covers with
labelling field



Packing 2
FUSION ALUM. 22983-AF
PRUSS. ALUM. 22983-AP
MALT GOLD 22983-DM
PEARL WHITE 22983-BP



Packing 2
MISTY BRON. 22983-BN
SAMOA B. 22983-MS
SATIN WHITE 22983-BS
AN. COSSO* 22983-AC

SC/APC fiber optic solutions

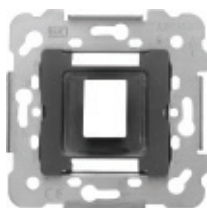

Adapter for 1 RJ connector standart Keystone 19582-1

Packing 10



Coupler for optical fibre connector Type SC/APC 3191

To be used with adapter 3190 or directly plugged in the RJ cover

Packing 20



Keystone adapter to be used with the coupler 3191 in RJ adapters 3190

For a proper use of this adapter an increased depth flush-mounting box is recommended.

Packing 20

Iris / Iris plus*

Packing 10	WHITE* 19782	BEIGE 19782-A	ODYSSEY G. 19782-OD	CHOCOLATE* 19782-CH
Packing 10	MERC. ALUM.* 19782-MA	NEP. STEEL 19782-AN	RUBY RED 19782-RR	JAIPUR C. 19782-CJ

Packing 2

Mega / Iris plus*

Packing 2	FUSION ALUM. 22782-AF	PRUSS. ALUM. 22782-AP	MALT GOLD 22782-DM	PEARL WHITE 22782-BP
Packing 2	MISTY BRON. 22782-BN	SAMOA B. 22782-MS	SATIN WHITE 22782-BS	AN. COSSO* 22782-AC

Iris / Iris plus*

Covers with labelling field

Packing 10	WHITE* 19783	BEIGE 19783-A	ODYSSEY G. 19783-OD	CHOCOLATE* 19783-CH
Packing 10	MERC. ALUM.* 19783-MA	NEP. STEEL 19783-AN	RUBY RED 19783-RR	JAIPUR C. 19783-CJ

Packing 2

* The colors of the Iris plus frames match the colors marked with an asterisk

Mega / Iris plus*

Covers with labelling field

Packing 2	FUSION ALUM. 22883-AF	PRUSS. ALUM. 22883-AP	MALT GOLD 22883-DM	PEARL WHITE 22883-BP
Packing 2	MISTY BRON. 22883-BN	SAMOA B. 22883-MS	SATIN WHITE 22883-BS	AN. COSSO* 22883-AC

SC/APC fiber optic solutions

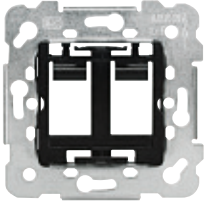

Adapter for 2 RJ connectors standart Keystone 19682-1

Packing 10



Coupler for optical fibre connector Type SC/APC 3191

To be used with adapter 3190 or directly plugged in the RJ cover

Packing 20



Keystone adapter to be used with the coupler 3191 in RJ adapters 3190

For a proper use of this adapter an increased depth flush-mounting box is recommended.

Packing 20

* The colors of the Iris plus frames match the colors marked with an asterisk

Iris / Iris plus*

Packing 10	WHITE* 19882	BEIGE 19882-A	ODYSSEY G. 19882-OD	CHOCOLATE* 19882-CH
Packing 10	MERC. ALUM.* 19882-MA	NEP. STEEL 19882-AN	RUBY RED 19882-RR	JAIPUR C. 19882-CJ

Mega / Iris plus*

Packing 2	FUSION ALUM. 22783-AF	PRUSS. ALUM. 22783-AP	MALT GOLD 22783-DM	PEARL WHITE 22783-BP
Packing 2	MISTY BRON. 22783-BN	SAMOA B. 22783-MS	SATIN WHITE 22783-BS	AN. COSSO* 22783-AC

Iris / Iris plus*

Covers with labelling field				
	Packing 10	WHITE* 19883	BEIGE 19883-A	ODYSSEY G. 19883-OD
Packing 10	MERC. ALUM.* 19883-MA	NEP. STEEL 19883-AN	RUBY RED 19883-RR	JAIPUR C. 19883-CJ

Mega / Iris plus*

Covers with labelling field				
	Packing 2	FUSION ALUM. 22983-AF	PRUSS. ALUM. 22983-AP	MALT GOLD 22983-DM
Packing 2	MISTY BRON. 22983-BN	SAMOA B. 22983-MS	SATIN WHITE 22983-BS	AN. COSSO* 22983-AC

Iris, Iris plus and Mega



Multi-connector

Multiple adapter for computer connectors with labelling field

Includes 5 adapters for different connectors

* The colors of the Iris plus frames match the colors marked with an asterisk

Included adapters for



Connector
SUB-D 9 pins

Connector
SUB-D 15 pins

Connector
Blank



Substrate
RJ45 connector



Connector
Twinaxial

Iris / Iris plus*



Mega / Iris plus*

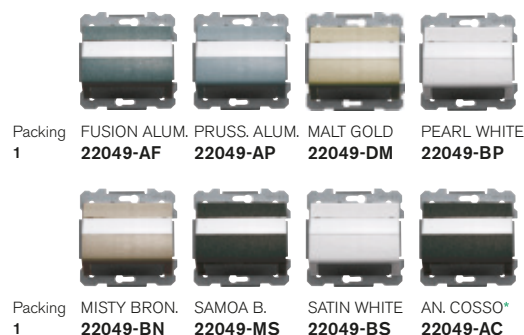

Voice and Data connectors and adapters

Adapter with French phone connector

* The colors of the Iris plus frames match the colors marked with an asterisk

Iris / Iris plus*



Mega / Iris plus*



Potentiometer for loudspeakers



Potentiometer 3 W - 27 Ω 18560
 Potentiometer 5 W - 47 Ω 18562
 *Potentiometer 5 + 5 W - 47 Ω 18564

*A deep flush-mounting box is required

Not suitable for claws

Packing 1

* The colors of the Iris plus frames match the colors marked with an asterisk

Iris / Iris plus*



Packing 10	WHITE* 18760	BEIGE 18760-A	ODYSSEY G. 18760-OD	CHOCOLATE* 18760-CH
------------	-----------------	------------------	------------------------	------------------------



Packing 10	MERC. ALUM.* 18760-MA	NEP. STEEL 18760-AN	RUBY RED 18760-RR	JAIPUR C. 18760-CJ
------------	--------------------------	------------------------	----------------------	-----------------------

Mega / Iris plus*



Packing 1	FUSION ALUM. 22760-AF	PRUSS. ALUM. 22760-AP	MALT GOLD 22760-DM	PEARL WHITE 22760-BP
-----------	--------------------------	--------------------------	-----------------------	-------------------------



Packing 1	MISTY BRON. 22760-BN	SAMOA B. 22760-MS	SATIN WHITE 22760-BS	AN. COSSO* 22760-AC
-----------	-------------------------	----------------------	-------------------------	------------------------

Loudspeaker socket outlets

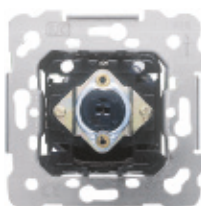

DIN loudspeaker socket outlet 18563
 Faston or soldered connection

Packing 10

* The colors of the Iris plus frames match the colors marked with an asterisk

Iris / Iris plus*



Packing 10	WHITE* 18763	BEIGE 18763-A	ODYSSEY G. 18763-OD	CHOCOLATE* 18763-CH
------------	-----------------	------------------	------------------------	------------------------



Packing 10	MERC. ALUM.* 18763-MA	NEP. STEEL 18763-AN	RUBY RED 18763-RR	JAIPUR C. 18763-CJ
------------	--------------------------	------------------------	----------------------	-----------------------

Mega / Iris plus*



Packing 1	FUSION ALUM. 22763-AF	PRUSS. ALUM. 22763-AP	MALT GOLD 22763-DM	PEARL WHITE 22763-BP
-----------	--------------------------	--------------------------	-----------------------	-------------------------



Packing 1	MISTY BRON. 22763-BN	SAMOA B. 22763-MS	SATIN WHITE 22763-BS	AN. COSSO* 22763-AC
-----------	-------------------------	----------------------	-------------------------	------------------------

Loudspeaker socket outlets

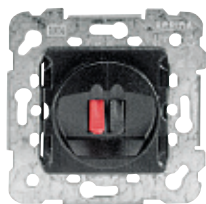

Loudspeaker socket outlet (mono) 18563-2

Rear screwed terminal

Packing 10

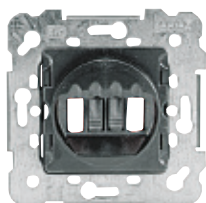

Loudspeaker socket outlet (stereo) 18563-4

Rear screwed terminal

Packing 10

* The colors of the Iris plus frames match the colors marked with an asterisk

Iris / Iris plus*

Packing 10	WHITE* 18730	BEIGE 18730-A	ODYSSEY G. 18730-OD	CHOCOLATE* 18730-CH
Packing 10	MERC. ALUM.* 18730-MA	NEP. STEEL 18730-AN	RUBY RED 18730-RR	JAIPUR C. 18730-CJ

Mega / Iris plus*

Packing 1	FUSION ALUM. 22730-AF	PRUSS. ALUM. 22730-AP	MALT GOLD 22730-DM	PEARL WHITE 22730-BP
Packing 1	MISTY BRON. 22730-BN	SAMOA B. 22730-MS	SATIN WHITE 22730-BS	AN. COSSO* 22730-AC

Loudspeaker socket outlets



Mono RCA socket outlet 18575

Rear screw-less terminal
Cable: maximum 3 pairs of 0.3 mm²

Packing 1

* The colors of the Iris plus frames match the colors marked with an asterisk

Iris / Iris plus*

Packing 10	WHITE* 18882	BEIGE 18882-A	ODYSSEY G. 18882-OD	CHOCOLATE* 18882-CH
Packing 10	MERC. ALUM.* 18882-MA	NEP. STEEL 18882-AN	RUBY RED 18882-RR	JAIPUR C. 18882-CJ

Mega / Iris plus*

Packing 1	FUSION ALUM. 22882-AF	PRUSS. ALUM. 22882-AP	MALT GOLD 22882-DM	PEARL WHITE 22882-BP
Packing 1	MISTY BRON. 22882-BN	SAMOA B. 22882-MS	SATIN WHITE 22882-BS	AN. COSSO* 22882-AC

Loudspeaker socket outlets



Stereo RCA socket outlet 18576

Rear screw-less terminal
Cable: maximum 3 pairs of 0.3 mm²

Packing 1

* The colors of the Iris plus frames match the colors marked with an asterisk

Iris / Iris plus*

Packing 10	WHITE* 18776	BEIGE 18776-A	ODYSSEY G. 18776-OD	CHOCOLATE* 18776-CH
Packing 10	MERC. ALUM.* 18776-MA	NEP. STEEL 18776-AN	RUBY RED 18776-RR	JAIPUR C. 18776-CJ

Mega / Iris plus*

Packing 1	FUSION ALUM. 22776-AF	PRUSS. ALUM. 22776-AP	MALT GOLD 22776-DM	PEARL WHITE 22776-BP
Packing 1	MISTY BRON. 22776-BN	SAMOA B. 22776-MS	SATIN WHITE 22776-BS	AN. COSSO* 22776-AC

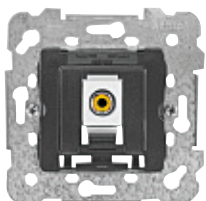

RCA video socket outlet 18877

Rear screw-less terminal
Cable: maximum 3 pairs of 0.3 mm²

Packing 1

* The colors of the Iris plus frames match the colors marked with an asterisk

Iris / Iris plus*

Packing 10	WHITE* 18882	BEIGE 18882-A	ODYSSEY G. 18882-OD	CHOCOLATE* 18882-CH
Packing 10	MERC. ALUM.* 18882-MA	NEP. STEEL 18882-AN	RUBY RED 18882-RR	JAIPUR C. 18882-CJ

Mega / Iris plus*

Packing 1	FUSION ALUM. 22882-AF	PRUSS. ALUM. 22882-AP	MALT GOLD 22882-DM	PEARL WHITE 22882-BP
Packing 1	MISTY BRON. 22882-BN	SAMOA B. 22882-MS	SATIN WHITE 22882-BS	AN. COSSO* 22882-AC

Iris, Iris plus and Mega



Other inserts



Fuse holder 18528

Max. fuses 16 A 250 V~ for ceramic fuse 8.5x31.5 mm

Packing 10

* The colors of the Iris plus frames match the colors marked with an asterisk

Iris / Iris plus*

Packing 10	WHITE* 18728	BEIGE 18728-A	ODYSSEY G. 18728-OD	CHOCOLATE* 18728-CH Packing 1
Packing 10	MERC. ALUM.* 18728-MA	NEP. STEEL 18728-AN	RUBY RED 18728-RR	JAIPUR C. 18728-CJ

Mega / Iris plus*

Packing 1	FUSION ALUM. 22728-AF	PRUSS. ALUM. 22728-AP	MALT GOLD 22728-DM	PEARL WHITE 22728-BP
Packing 1	MISTY BRON. 22728-BN	SAMOA B. 22728-MS	SATIN WHITE 22728-BS	AN. COSSO* 22728-AC

Fuse-holder cap

Spare part for item Ref. 18528

* The colors of the Iris plus frames match the colors marked with an asterisk

Iris / Iris plus*

Packing 10	WHITE* 18029	BEIGE 18029-A	ODYSSEY G. 18029-OD	CHOCOLATE* 18029-CH
Packing 10	MERC. ALUM.* 18029-MA	NEP. STEEL 18029-AN	RUBY RED 18029-RR	JAIPUR C. 18029-CJ

Mega / Iris plus*

Packing 10	FUSION ALUM. 22029-AF	PRUSS. ALUM. 22029-AP	MALT GOLD 22029-DM	PEARL WHITE 22029-BP
Packing 10	MISTY BRON. 22029-BN	SAMOA B. 22029-MS	SATIN WHITE 22029-BS	AN. COSSO* 22029-AC

Multimedia connectors



Double USB charger 5TG2025-3

- Input rated voltage: 100-250V AC
- Nominal frequency: 50-60Hz
- 2 x USB type A female
- Output rated voltage: 5 V DC
- Max. total current: 2,1A
- Consumption on standby: < 100mW
- complies with the ErP European Directive
- Short circuit protection
- Temperature protection

Standards and certificates: EN 62386-1

Packing 1

* The colors of the Iris plus frames match the colors marked with an asterisk



Type-A HDMI connector

Screwed terminals

- White **18578-HDMI**
- Beige **18578-HDMI-A**
- Grey **18578-HDMI-G**

Packing 1



VGA connector

Maximum cable length 30 m.
(depending on the type of cables)

Screwed terminals

- White **18578-VGA**
- Beige **18578-VGA-A**
- Grey **18578-VGA-G**

Packing 1



Type-A USB connector

Compatible with USB 2.0

Screwed terminals

- White **18578-USB**
- Beige **18578-USB-A**
- Grey **18578-USB-G**

Packing 1

* The colors of the Iris plus frames match the colors marked with an asterisk

Iris / Iris plus*



Packing 1 WHITE* **18780-USB** ODYSSEY G. **18780-USB-OD** CHOCOLATE* **18780-USB-CH**



Packing 1 MERC. ALUM.* **18780-USB-MA** NEP. STEEL **18780-USB-AN**

Mega / Iris plus*



Packing 1 FUSION ALUM. **22780-USB-AF** PRUSS. ALUM. **22780-USB-AP** MALT GOLD **22780-USB-DM** PEARL WHITE **22780-USB-BP**



Packing 1 MISTY BRON. **22780-USB-BN** SAMOA B. **22780-USB-MS** SATIN WHITE **22780-USB-BS** AN. COSSO* **22780-USB-AC**

Iris / Iris plus*



Packing 1 WHITE* **18778** BEIGE **18778-A** ODYSSEY G. **18778-OD** CHOCOLATE* **18778-CH**



Packing 1 MERC. ALUM.* **18778-MA** NEP. STEEL **18778-AN** RUBY RED **18778-RR** JAIPUR C. **18778-CJ**

Mega / Iris plus*



Packing 1 FUSION ALUM. **22778-AF** PRUSS. ALUM. **22778-AP** MALT GOLD **22778-DM** PEARL WHITE **22778-BP**



Packing 1 MISTY BRON. **22778-BN** SAMOA B. **22778-MS** SATIN WHITE **22778-BS** AN. COSSO* **22778-AC**

Iris, Iris plus and Mega



Other inserts





Blank cover

* The colors of the Iris plus frames match the colors marked with an asterisk

Iris / Iris plus*

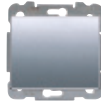
				
Packing 10	WHITE* 18033	BEIGE 18033-A	ODYSSEY G. 18033-OD	CHOCOLATE* 18033-CH
				
Packing 10	MERC. ALUM.* 18033-MA	NEP. STEEL 18033-AN	RUBY RED 18033-RR	JAIPUR C. 18033-CJ

Mega / Iris plus*

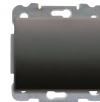
				
Packing 1	FUSION ALUM. 22033-AF	PRUSS. ALUM. 22033-AP	MALT GOLD 22033-DM	PEARL WHITE 22033-BP
				
Packing 1	MISTY BRON. 22033-BN	SAMOA B. 22033-MS	SATIN WHITE 22033-BS	AN. COSSO* 22033-AC

Room thermostats



Electronic thermostat for heating or cooling **18544**

230 V~/1900 W $\cos \varphi = 1$
230 V~/450 W $\cos \varphi = 0,6$
Regulation from 5 °C a 30 °C
Hysteresis ± 1 °C

Packing 1

* The colors of the Iris plus frames match the colors marked with an asterisk

Iris / Iris plus*

				
Packing 1	WHITE* 18744	BEIGE 18744-A	ODYSSEY G. 18744-OD	CHOCOLATE* 18744-CH
				
Packing 1	MERC. ALUM.* 18744-MA	NEP. STEEL 18744-AN	RUBY RED 18744-RR	JAIPUR C. 18744-CJ

Mega / Iris plus*

				
Packing 1	FUSION ALUM. 22744-AF	PRUSS. ALUM. 22744-AP	MALT GOLD 22744-DM	PEARL WHITE 22744-BP
				
Packing 1	MISTY BRON. 22744-BN	SAMOA B. 22744-MS	SATIN WHITE 22744-BS	AN. COSSO* 22744-AC

Room thermostats

Heating and cooling electronic room thermostat

5 A (2 A) 230 V~ regulation from 5 to 30 °C

Night-time reduction: The thermostat incorporates a second resistor which, through a timer switch, can be turned on at scheduled time achieving a temperature downsize of 5 °C

Packing 1

Heated floor thermostat

Control of floor temperature in facilities with heated floor heating. Night reduction via signal from external programmer. "Heating connected" and "reduced functions" indicator light.

On/off switch.

For installing into 60mm mounting box

Temperature indicator light: *..5 [= 10..50 °C]

Power supply: 230 V_{AC} [195...253 V] 50 Hz

Remote sensor: length. 4m [extendable to 50 m]

Room temperature 0..40 °C

Hysteresis ±1°

Packing 1

Iris



WHITE
18144



BEIGE
18144-A



WHITE
18244

Iris, Iris plus and Mega



Motion detector



Motion detector 3 wire insert 18555-3

Contact capacity (3-wire, relay output):
Resistive load 2,300 W, 10 at max, $\cos \varphi = 1$
Inductive load 1.500 W, 5 to max., $\cos \varphi = 0,6$
Halogen Lamps with transformer 1000 VA
Electronic ballasts. 2 x 36 W (20 max)
Compatible with LED loads

Packing 1

Motion detector 18555

Not suitable for claws
Detection angle 180° horizontal / 60° vertical
Timing from 4s to 10min
Power supply voltage 230 V +6 % - 10 %
Range (1.2-2.2 m mounting height), maximum
8 m for lateral movement, approx. 3 m for
frontal movement.
Twilight level of 5 to 1000 lux
Contact capacity (2-wire, triac output):
Incandescent/ Halogen 40 - 300 W Max.
Minimum load 40 W

Packing 1

* The colors of the Iris plus frames match the colors marked with an asterisk

Iris / Iris plus*

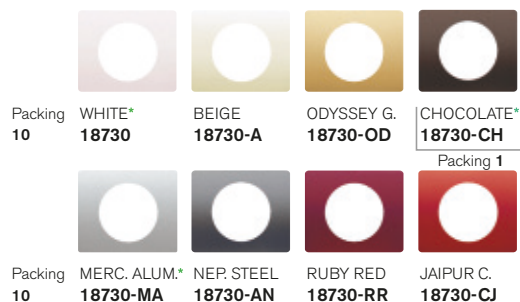

Mega / Iris plus*

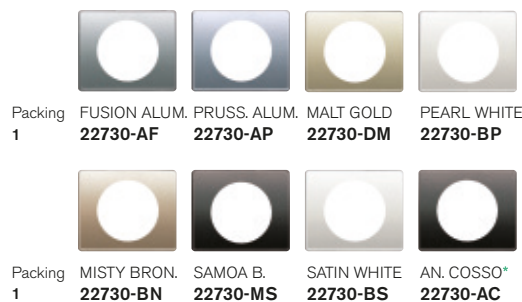

Ceiling movement detectors



Ceiling detector, 360° range for flush mounting 2391

Power supply voltage: 230Vac 50Hz.
Consumption <1W.
Contact Capacity: 16A $\cos \varphi = 1$
Incandescent or halogen 230V: 3,000W
Halogen lamps with electronic transformer: 3,000W
Halogen lamps with ferromagnetic transformer: 2,400W
Fluorescence: 1.300W (130 μ F)
Fluo-compact: 18x7W, 12x11W, 10x15W, 10x20W, 10x23W.
Detection area: 7 m, 360°.
Compatible with LED lamps
Requires neutral connection.

Packing 1



Ceiling detector, 360° range for surface mounting 2390

Power supply voltage: 230Vac 50Hz.
Consumption <1W.
Contact Capacity: 16A $\cos \varphi = 1$
Incandescent or halogen 230V: 3,000W
Halogen lamps with electronic transformer: 3,000W
Halogen lamps with ferromagnetic transformer: 2,400W
Fluorescence: 1.300W (130 μ F)
Fluo-compact: 18x7W, 12x11W, 10x15W, 10x20W, 10x23W.
Detection area: 7 m, 360°.
Compatible with LED lamps
Requires neutral connection.

Packing 1

Sound









Adapter for sound modules (Sonelco, Eis, Tez, Sonbel)

Depending on each manufacturer,
a specific fixing frame will be added









☑ 46 x 46 mm

* The colors of the Iris plus frames match the colors
marked with an asterisk

Iris / Iris plus*

				
Packing 10	WHITE* 18742	BEIGE 18742-A	ODYSSEY G. 18742-OD	CHOCOLATE* 18742-CH
				
Packing 10	MERC. ALUM.* 18742-MA	NEP. STEEL 18742-AN	RUBY RED 18742-RR	JAIPUR C. 18742-CJ

Mega / Iris plus*

				
Packing 1	FUSION ALUM. 22742-AF	PRUSS. ALUM. 22742-AP	MALT GOLD 22742-DM	PEARL WHITE 22742-BP
				
Packing 1	MISTY BRON. 22742-BN	SAMOA B. 22742-MS	SATIN WHITE 22742-BS	AN. COSSO* 22742-AC

Adapter for sound modules EGI

Direct adaptation to the sound module
fixing frames









☑ 41 x 41 mm

* The colors of the Iris plus frames match the colors
marked with an asterisk

Iris / Iris plus*

				
Packing 10	WHITE* 18743	BEIGE 18743-A	ODYSSEY G. 18743-OD	CHOCOLATE* 18743-CH
				
Packing 10	MERC. ALUM.* 18743-MA	NEP. STEEL 18743-AN	RUBY RED 18743-RR	JAIPUR C. 18743-CJ

Mega / Iris plus*

				
Packing 1	FUSION ALUM. 22743-AF	PRUSS. ALUM. 22743-AP	MALT GOLD 22743-DM	PEARL WHITE 22743-BP
				
Packing 1	MISTY BRON. 22743-BN	SAMOA B. 22743-MS	SATIN WHITE 22743-BS	AN. COSSO* 22743-AC

Flush-mounting boxes



Flush-mounting box 2373-I
Thermoplastic material
Dimensions: 71x71x43 mm
Packing 640



Protective cover 2374-I
Allows you to locate the box after plastering
Packing 1000



Claws 16-GAR for metal frames
Bag with 50 claws and 50 screws
To mount 25 frames



Flush-mounting box 2341
1 element for plasterboard wall
Packing 120



Flush-mounting box 2342
2 elements for plasterboard wall
Packing 60



Flush-mounting box 2343
3 elements for plasterboard wall
Packing 35



Flush-mounting box 2344
4 elements for plasterboard wall
Packing 30



Flush-mounting box 2345
5 elements for plasterboard wall
Packing 21



Hole saw hardened teeth shank for plasterboard wall
diam. 68mm
depth 40mm
Packing 1



Deburrer for Plasterboard 5892000
Ø 68 mm **NEW**
Tool for flush installation of hollow wall boxes
Packing 1



Replacement blades 5893000
for ref. 5892000 **NEW**
Packing 1

Note: Check the price list published on our website, www.bjc.es, for availability of inserts with claws that are identified with -X after the reference. To achieve the designed installation results, the use of these boxes and the hole saw hardened teeth shank is recommended.

Iris Frames



WHITE Packing

18001	10
18002	10
18003	5
18004	5
18005	1
18102	10
18103	5
18104	5



BEIGE Packing

18001-A	10
18002-A	10
18003-A	5
18004-A	5
18005-A	1
18102-A	10
18103-A	5
18104-A	5



ODISSEY GOLD Packing

18001-OD	10
18002-OD	10
18003-OD	5
18004-OD	5
18005-OD	1
18102-OD	10
18103-OD	5
18104-OD	5



ACERO NEPTUNO Envase

18001-AN	10
18002-AN	10
18003-AN	5
18004-AN	5
18005-AN	1
18102-AN	10
18103-AN	5
18104-AN	5



RUBY RED Packing

18001-RR	10
18002-RR	10
18003-RR	5
18004-RR	5
18005-RR	1
18102-RR	10
18103-RR	5
18104-RR	5



MERCURY ALUMINIUM Packing

18001-MA	10
18002-MA	10
18003-MA	5
18004-MA	5
18005-MA	1
18102-MA	10
18103-MA	5
18104-MA	5



JAIPUR COPPER Packing

18001-CJ	10
18002-CJ	10
18003-CJ	5
18004-CJ	5
18005-CJ	1
18102-CJ	10
18103-CJ	5
18104-CJ	5



BEIGE CEMENTO Envase

18001-BC	1
18002-BC	1
18003-BC	1
18004-BC	1
18005-BC	1
18102-BC	1
18103-BC	1
18104-BC	1



CHOCOLATE Packing

18001-CH	1
18002-CH	1
18003-CH	1
18004-CH	1
18005-CH	1
18102-CH	1
18103-CH	1
18104-CH	1

MEASUREMENTS

	85 x 84 mm
	85 x 155 mm
	85 x 226 mm
	85 x 298 mm
	85 x 370 mm
	156 x 84 mm
	228 x 84 mm
	299 x 84 mm

Iris Frames with Siemens logo



POLAR WHITE Packing

	S18001	10
	S18002	10
	S18003	5
	S18004	5
	S18005	1
	S18102	10
	S18103	5
	S18104	5



BEIGE Packing

	S18001-A	10
	S18002-A	10
	S18003-A	5
	S18004-A	5
	S18005-A	1
	S18102-A	10
	S18103-A	5
	S18104-A	5

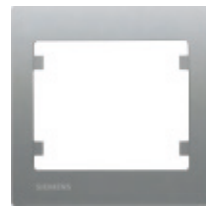

MERCURY ALUMINIUM Packing

	S18001-MA	10
	S18002-MA	10
	S18003-MA	5
	S18004-MA	5
	S18005-MA	1
	S18102-MA	10
	S18103-MA	5
	S18104-MA	5



ODISSEY GOLD Packing

	S18001-OD	10
	S18002-OD	10
	S18003-OD	5
	S18004-OD	5
	S18005-OD	1
	S18102-OD	10
	S18103-OD	5
	S18104-OD	5



NEPTUNE STEEL Packing

	S18001-AN	10
	S18002-AN	10
	S18003-AN	5
	S18004-AN	5
	S18005-AN	1
	S18102-AN	10
	S18103-AN	5
	S18104-AN	5

MEASUREMENTS

	85 x 84 mm
	85 x 155 mm
	85 x 226 mm
	85 x 298 mm
	85 x 370 mm
	156 x 84 mm
	228 x 84 mm
	299 x 84 mm

Iris plus Frames



WHITE Packing

	18011	10
	18012	10
	18013	5
	18014	5
	18112	10
	18113	5



MERCURY ALUMINIUM Packing

	18011-MA	10
	18012-MA	10
	18013-MA	5
	18014-MA	5
	18112-MA	10
	18113-MA	5



ANTHRACITE COSSO Packing

	18011-AC	1
	18012-AC	1
	18013-AC	1
	18014-AC	1
	18112-AC	1
	18113-AC	1



CHOCOLATE Packing

	18011-CH	1
	18012-CH	1
	18013-CH	1
	18014-CH	1
	18112-CH	1
	18113-CH	1

For a correct installation of Iris plus frames on plasterboard walls, it is necessary to use the hole saw hardened teeth shank 2158000 (or equivalent) for a right flush installation in the wall.

MEASUREMENTS

	93 x 82 mm
	164 x 82 mm
	236 x 82 mm
	307 x 82 mm
	153 x 93 mm
	225 x 93 mm

Iris plus Frames with Siemens logo



WHITE Packing

	S18011	10
	S18012	10
	S18013	5
	S18112	1

Mega Frames

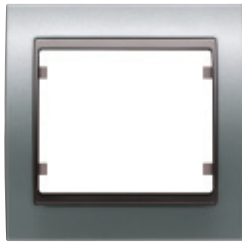

FUSION ALUMINIUM Packing

	22001-AF	1
	22002-AF	1
	22003-AF	1
	22004-AF	1
	22102-AF	1
	22103-AF	1
	22104-AF	1

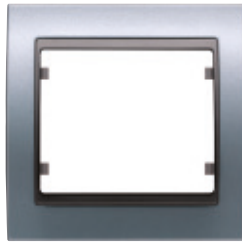

PRUSSIAN ALUMINIUM Packing

	22001-AP	1
	22002-AP	1
	22003-AP	1
	22004-AP	1
	22102-AP	1
	22103-AP	1
	22104-AP	1



MALT GOLD Packing

	22001-DM	1
	22002-DM	1
	22003-DM	1
	22004-DM	1
	22102-DM	1
	22103-DM	1
	22104-DM	1



PEARL WHITE MABE Packing

	22001-BP	1
	22002-BP	1
	22003-BP	1
	22004-BP	1
	22102-BP	1
	22103-BP	1
	22104-BP	1



MISTY BRONZE Packing

	22001-BN	1
	22002-BN	1
	22003-BN	1
	22004-BN	1
	22102-BN	1
	22103-BN	1
	22104-BN	1

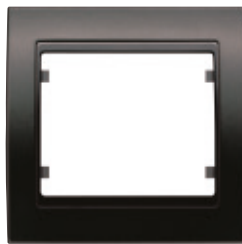

SAMOA BROWN Packing

	22001-MS	1
	22002-MS	1
	22003-MS	1
	22004-MS	1
	22102-MS	1
	22103-MS	1
	22104-MS	1



SATIN WHITE Packing

	22001-BS	1
	22002-BS	1
	22003-BS	1
	22004-BS	1
	22102-BS	1
	22103-BS	1
	22104-BS	1



MALT GOLD COSSO Packing

	22001-DMC	1
	22002-DMC	1
	22003-DMC	1
	22004-DMC	1
	22102-DMC	1
	22103-DMC	1
	22104-DMC	1

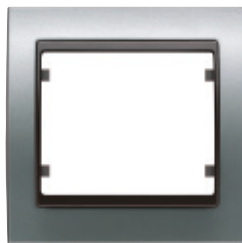

FUSION ALUMINIUM. COSSO Packing

	22001-AFC	1
	22002-AFC	1
	22003-AFC	1
	22004-AFC	1
	22102-AFC	1
	22103-AFC	1
	22104-AFC	1

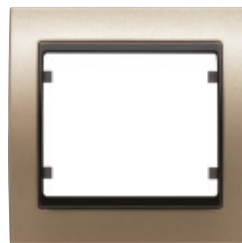

MISTY BRONZE COSSO Packing

	22001-BNC	1
	22002-BNC	1
	22003-BNC	1
	22004-BNC	1
	22102-BNC	1
	22103-BNC	1
	22104-BNC	1



MABE PEARL WHITE COSSO Packing

	22001-BPC	1
	22002-BPC	1
	22003-BPC	1
	22004-BPC	1
	22102-BPC	1
	22103-BPC	1
	22104-BPC	1

Mega Frames

Pure metal



ALUMINIUM	Packing
22001-AG	1
22002-AG	1
22003-AG	1
22004-AG	1
22102-AG	1
22103-AG	1
22104-AG	1

GOLD	Packing
22001-DG	1
22002-DG	1
22003-DG	1
22004-DG	1
22102-DG	1
22103-DG	1
22104-DG	1

Textured metal

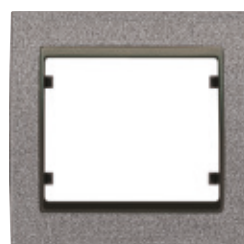
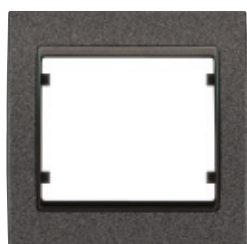

EBONY BLACK COSSO	Packing
22001-NEC	1
22002-NEC	1
22003-NEC	1
22004-NEC	1
22102-NEC	1
22103-NEC	1
22104-NEC	1

MOCHA BROWN COSSO	Packing
22001-MMC	1
22002-MMC	1
22003-MMC	1
22004-MMC	1
22102-MMC	1
22103-MMC	1
22104-MMC	1

ASH GREY	Packing
22001-GCC	1
22002-GCC	1
22003-GCC	1
22004-GCC	1
22102-GCC	1
22103-GCC	1
22104-GCC	1

MEASUREMENTS

	90 x 90 mm		90 x 161 mm
	161 x 90 mm		90 x 232,5 mm
	232,5 x 90 mm		90 x 304 mm
	304 x 90 mm		

Mega Luminous Frames

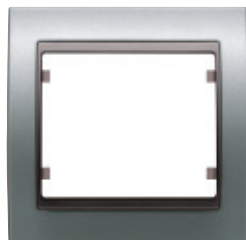

FUSION ALUMINIUM Packing
 22001-AFL 1



PRUSSIAN ALUMINIUM Packing
 22001-APL 1



MALT GOLD Packing
 22001-DML 1



MABE PEARL WHITE Packing
 22001-BPL 1



MISTY BRONZE Packing
 22001-BNL 1



SATIN WHITE Packing
 22001-BSL 1



FUSION ALUMINIUM
 COSSO Packing
 22001-AFCL 1



MISTY BRONZE
 COSSO Packing
 22001-BNCL 1



MABE PEARL WHITE
 COSSO Packing
 22001-BPCL 1



SAMOA BROWN Packing
 22001-MSL 1



MALT GOLD COSSO Packing
 22001-DMCL 1

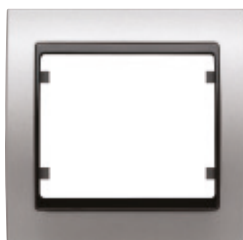

ALUMINIUM Packing
 22001-AGL 1



GOLD Packing
 22001-DGL 1

Please check availability. On request.

Mega Luminous Frames

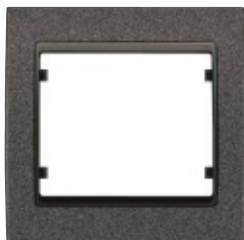

EBONY BLACK
COSSO Packing

□ 22001-NECL 1



MOCHA BROWN
COSSO Packing

□ 22001-MMCL 1

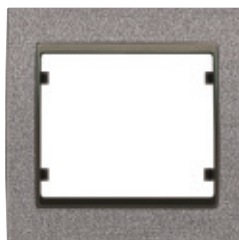

ASH GREY Packing

□ 22001-GCCL 1

Please check availability. On request.



Simple frame laterally illuminated by blue LED in the shape of a fan on the wall on both sides.

230 V~ 50-60Hz 20mA

The frame is connected via cable and can be connected as the regular indicator light (by directly connecting it to the terminals of the input and output mechanism), the control or directly to phase and neutral in order for it to always be connected.

It can also be used in sockets where it is always on, as long as there is voltage, or even with a dimmer.

It cannot be used in signalling mode (2 wires) for electronic equipment with minimum load (e.g. presence detector 18555), although, in this case, it could be used if it were permanently connected with neutral connected to the box. (This item cannot be fitted with mechanisms manufactured before 2009).

MEASUREMENTS



90 x 90 mm

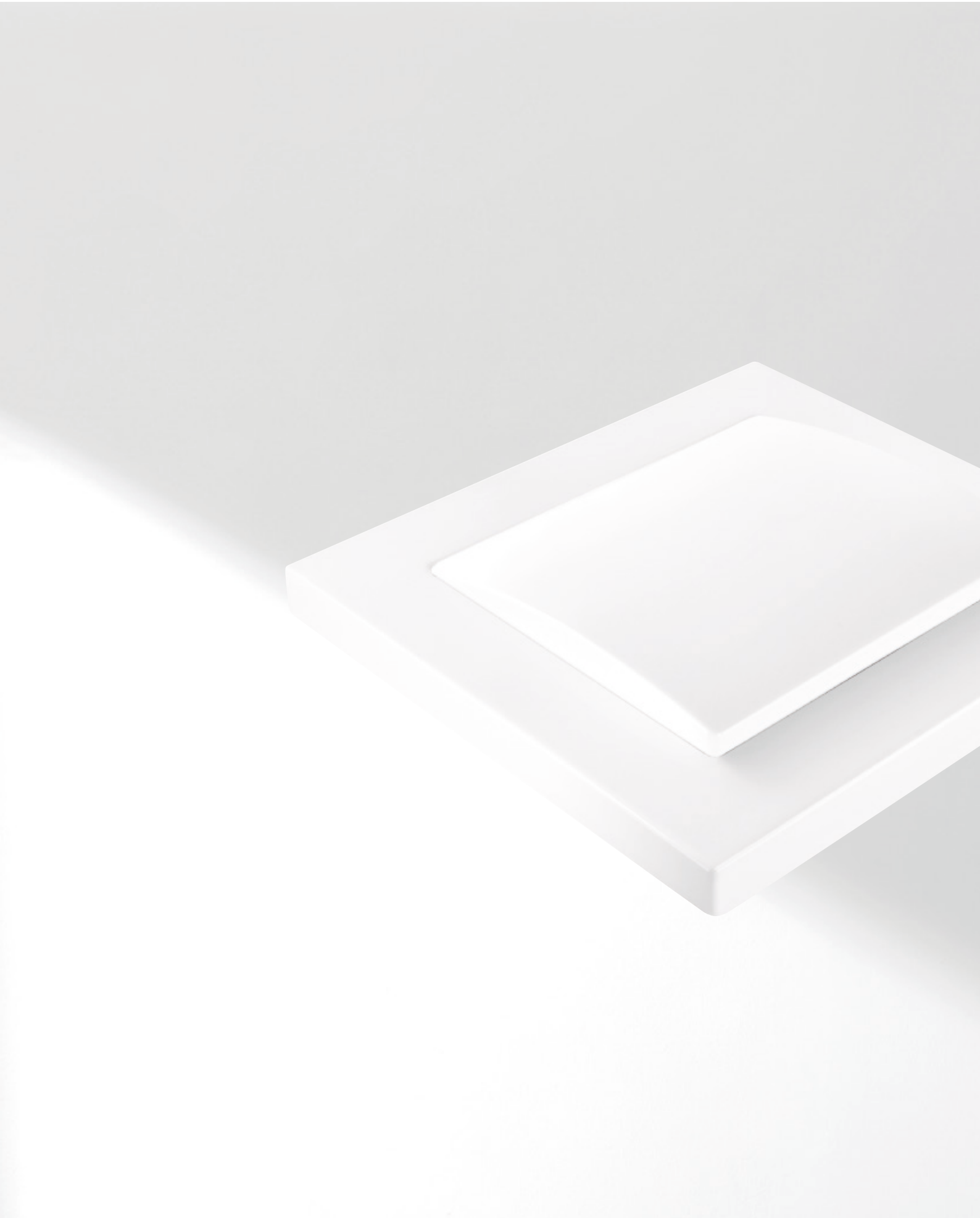

Anti-bacterial solutions

The antibacterial finish of Iris and Iris plus impedes the survival and transmission of microorganisms, which makes it the perfect ally for places where they flourish and where transmission can be high, such as hospitals, residential homes and care centres and the common areas of offices or residents' associations.

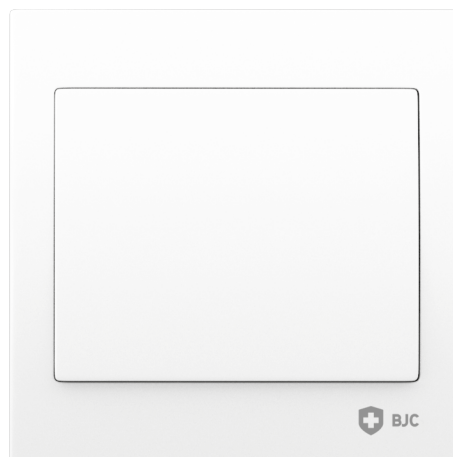

Switches

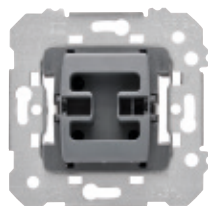

One-way switch 18505
Two-way switch 18506
 16 A 250 V~
Intermediate switch 18507
 10 A 250 V~

Packing 10

Anti-bacterial single rocker



Packing WHITE
 1 18705-BF

Switches

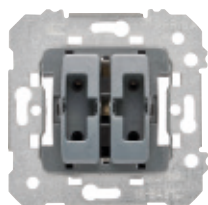

Double one-way switch 18509
Double two-way switch 18510
 16 A 250 V~
Double push-button 18511
 10 A 250 V~
Double push-button normally-closed 18513
 10 A 250 V~

Packing 10

Anti-bacterial double rocker



Packing WHITE
 1 18709-BF

Push-buttons

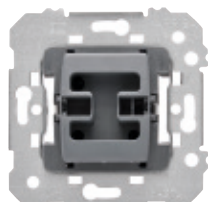

Push-button, normally-open 18516
Push-button, normally-closed 18512
 10 A 250 V~

Packing 10

Anti-bacterial with bell symbol rocker



Packing WHITE
 1 18716-BF

Anti-bacterial with light symbol rocker



Packing WHITE
 1 18717-BF

Inserts for blinds

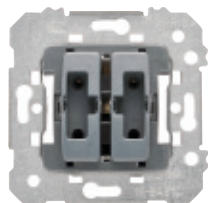

Double push-button for blinds 18565
 With electrical interlocking device
Double switch for blinds 18569
 With electrical and mechanical interlocking device
 10 A 250 V~
 Packing 10

Double push-button for blinds 18511
 Suitable to connect any blind control device
 10 A 250 V~
 Packing 10

Anti-bacterial double rocker for blinds

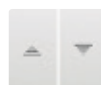

Packing WHITE
 1 18765-BF

Iris, Iris plus

Cord operated push-button

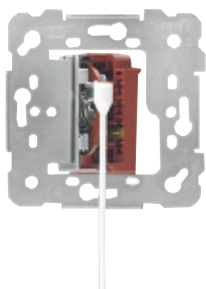

Cord operated push-button 18521
Cord operated two-way switch 18598
Insert not suitable for claws
10 A 250 V~
Packing 10

The handle does not have anti-bacterial finish

Anti-bacterial cord operated push-button cover



Packing WHITE
1 18734-BF

Socket outlets with increased touch protection

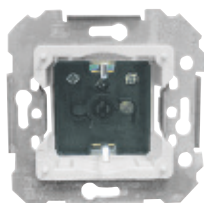

Schuko® socket outlet with increased touch protection 18524
Screwed terminals 16 A 250 V~

Packing 10

Anti-bacterial Schuko® cover



Packing WHITE
1 18724-BF

Voice and Data connectors and adapters

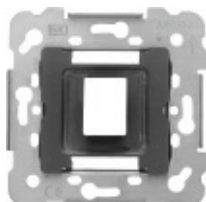

Adapter for 1 RJ45/RJ11 connector (AMP, ITT, etc.) 19582-1

Packing 10

Anti-bacterial voice and data cover



Packing WHITE
1 19782-BF

TV-FM socket outlet

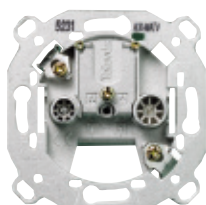

TV-FM socket outlets
Series 2-10 2932
Final outlet 2933
Individual installation 2934
(Manufacturer TELEVÉS)

Packing 10

TV-FM socket outlets are according to UNE 20523 and CEI 169-2 standards

Anti-bacterial TV-FM cover



Packing WHITE
1 18330-BF

Key card switch

Key card switch with 1 built-in microswitch and indicator light

With built-in neon lamp 250Vac
Resistive load 10A
Inductive load 1,5A

The use of a contactor for inductive loads is recommended

This product includes the visor without anti-bacterial finish.



Packing 1 WHITE
18068-BF

Microswitch for key card switch 2368

Enables to replace or add a microswitch to 22068 key card switch

Packing 10



Iris, Iris plus

Anti-bacterial frames

Iris



WHITE	Packing
18001-BF	1
18002-BF	1
18003-BF	1
18004-BF	1
18102-BF	1

Iris plus



WHITE	Packing
18011-BF	1
18012-BF	1
18013-BF	1
18014-BF	1
18112-BF	1

MEASUREMENTS

	85 x 84 mm
	85 x 155 mm
	85 x 226 mm
	85 x 298 mm
	156 x 84 mm

MEASUREMENTS

	93 x 82 mm
	164 x 82 mm
	236 x 82 mm
	307 x 82 mm
	153 x 93 mm

Antibacterial treatment inserted into the material of the components. It's not a superficial treatment.



Iris IP44

Iris design, now available for outdoor solutions

There are a wide range of spaces with environmental and humidity conditions that require additional protection. Gardens, terraces and garages are areas in which we carry out different activities, often associated with leisure, and we wish to have the comfort of electricity inside our homes. BJC presents the Iris IP44 series, to cater to these needs.

A flush-mounted series that combines the elegance and smooth curves of the Iris design with an IP44 degree of protection to guarantee protection against water splashed in any direction and water-tightness against liquid particles with diameters as small as 1 mm.



* Iris

* Iris IP44



Design detail in a "V" shape of the membrane's outline.

Protection IP44 with the elegance of BJC Iris.

Its structure is fitted with a complete safety system that guarantees IP-44 protection and which, in turn, blends in perfectly with the design of the Iris series. It keeps the same depth, and conserves all the balance and elegance of the original look; so much so that it is difficult to tell the two options apart.

IP-44 PROTECTION WITH NO ADDED VOLUME

EPDM membrane protecting the entire perimeter of the frame.

- Thermoplastic elastomer with high insulating capacity.
- Widely used for sealing and insulation in the automobile and construction industries. The membrane is set within the frame of the article, forming an indivisible unit.
- Offers a high level of water tightness without affecting the design. This effect is due to the exclusive V-shaped profile which, when installed, is hidden behind the frame, for added impermeability, but above all, with no extra volume.

Polycarbonate frame.

Polycarbonate frame with EPDM membrane set in a single invisible piece.

Zamak frame.

- Material with high mechanical resistance.
- Allows tight screwing during assembly, permitting the EPDM membrane to be hidden inside the frame.
- Rustproof

Iris IP44

Switch IP44. Step-by-step safety

Iris IP44 switches offer protection in the frame, with an EPDM membrane that protects its entire perimeter and extends to the rocker through a second membrane in the intermediate piece. This structure provides the IP44 protection that allows it to comply with the safety regulations in wet premises.



Middle piece protecting the rocker with an EPDM membrane.



Polycarbonate frame with EPDM membrane set in a single invisible piece.



Insert with Zamak frame to withstand tight screwing, allowing the EPDM membrane to be hidden within the frame.

Power protection IP44. Security step-by-step

Iris IP44 socket outlets are fitted with the EPDM membrane in the frame that is characteristic of the series, as well as a hinged polycarbonate protective lid. The socket outlets and the hinged lid have a special design with an interior circuit for expelling water through two outlets in the lower part, preventing it from seeping into the insert.

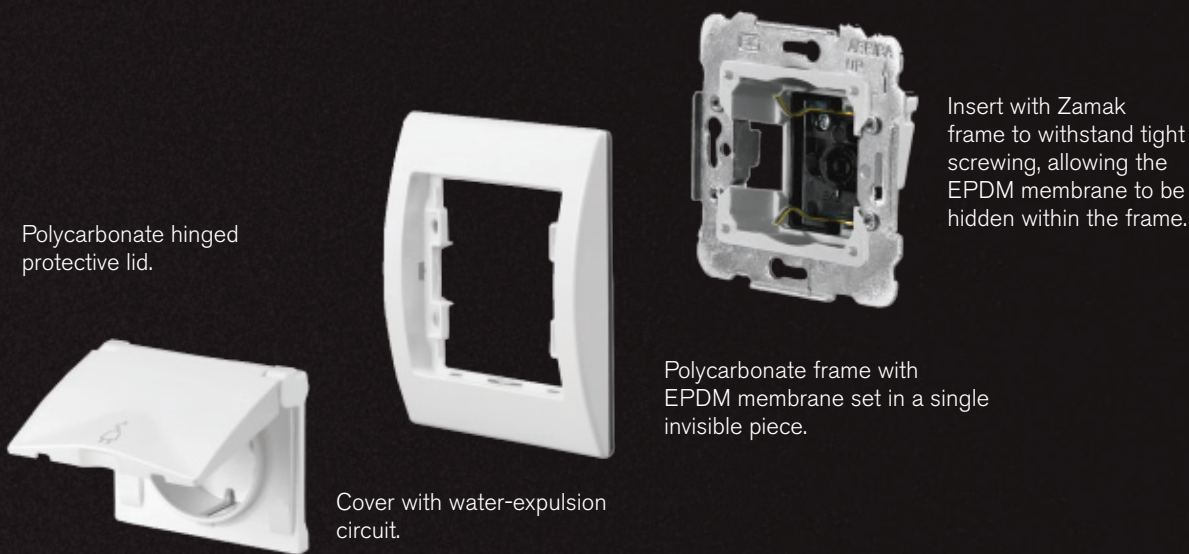

Polycarbonate hinged lid:

- Incorporates a water-expulsion circuit.
- It is specially treated to delay the effects of UV rays.
- Hinged to provide the socket outlet with the best possible protection against water.

Water-expulsion circuit:

The socket outlet and the cover have a special design with an interior circuit for expelling water through two outlets in the lower part, preventing it from seeping into the inserts.

Socket outlet cover:

- Design features a water outlet circuit.
- Extruded perimeter that prevents the entry of water into the socket outlet.
- The hinge of the cover acts as extra protection, fitting tightly with the frame and the EPDM set therein.



Detail of the design of the water circuit and its route.



Two outlets in the lower part of the socket outlet ensure that the water is expelled.

White



Two-way switch
Intermediate switch
2 pole one-way switch
 16 A 250 V~
 Packing 10

185006
 185007
 185008



Two-way switch
with indicator light
 16 A 250 V~
 Packing 10

185006-L



Double two-way switch
 16 A 250 V~
 Packing 1

185010



Double push-button
for blinds electric interlocking
device
 10 A 250 V~
 Packing 10

185065



Push-button, bell symbol
 10 A 250 V~
 Packing 10

185016



Push-button with
indicator light and bell symbol
 10 A 250 V~
 Packing 10

185016-L



1-gang frame

185001



Push-button, bulb symbol
 10 A 250 V~
 Packing 10

185017



Push-button with
indicator light and bulb symbol
 10 A 250 V~
 Packing 10

185017-L



2-gang frame

185002



Schuko® socket outlet with
increased touch protection
 16 A 250 V~
 Packing 10

185024



Blank cover
 Packing 10

185033



RTV/SAT socket outlet,
individual installation
 Packing 10

185935-X

Beige



Two-way switch
Intermediate switch
2 pole one-way switch
 16 A 250 V~
 Packing 10

185006-A
 185007-A
 185008-A



Two-way switch
with indicator light
 16 A 250 V~
 Packing 10

185006-AL



Double two-way switch
 16 A 250 V~
 Packing 1

185010-A



Double push-button
for blinds electric interlocking
device
 10 A 250 V~
 Packing 10

185065-A



Push-button, bell symbol
 10 A 250 V~
 Packing 10

185016-A



Push-button with
indicator light and bell symbol
 10 A 250 V~
 Packing 10

185016-AL



1-gang frame

185001-A



Push-button, bulb symbol
 10 A 250 V~
 Packing 10

185017-A



Push-button with
indicator light and bulb symbol
 10 A 250 V~
 Packing 10

185017-AL



2-gang frame

185002-A



Schuko® socket outlet with
increased touch protection
 16 A 250 V~
 Packing 10

185024-A



Blank cover
 Packing 10

185033-A



RTV/SAT socket outlet,
individual installation
 Packing 10

185935-AX

SIEMENS

Style

Unmistakeable and elegant

The Style series is the modern archetype of the traditional series, both in terms of aesthetics and functions, which go beyond fashion trends. With regards to its appearance, the Style series has remained unchanged in many aspects, which still make its functional version one of the most recognised and recognisable.

New collection of Siemens one-way switches and mechanisms: design, elegance and technology for homes, offices and hotels.



Polar White



Platinum Metallic



Cosso Anthracite



Chocolate



Malt Gold







Polar White



Platinum Metallic



Cosso Anthracite



Chocolate



Malt Gold

In some cases, we need a touch of style and elegance that goes beyond clichés. The singular aesthetics of the elements of the Style series can be combined into elegant solutions that can be fully integrated into the spaces of modern buildings. A very popular concept in the residential and tertiary sectors.



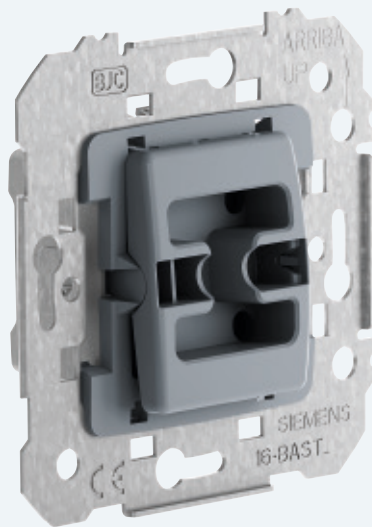

Its structure has an ergonomic design to guarantee easy, quick and comfortable installation. It features a compact mechanism to use all space inside the mounting box and facilitates cable routing. It is designed to ensure proper installation.

- One-way and two-way MEC18 switches rated at 16A are used, allowing many different applications with the same mechanism and reducing the number of items and references that must be stocked.
- Galvanised steel fixing frames with anti-corrosion treatment to ensure durable installation components.
- Fixing frames with upper and lower profiles to facilitate assembly and a rigid position of the mechanism.

The socket outlets feature increased touch protection elements and use standard STAI connectors (open safety screw system), which only require connection and tightening. The screws close with a single operation and have an engraved floating nut which prevents the cable from slipping and guarantees perfect fixture across the whole of the contact surface. The three conductors enter through the top of the socket outlet. They are also screwed on one side of the socket outlet. The outlets, which are supplied separately from the covers, allow terminal connection and fast and safe fixture.

Certifications

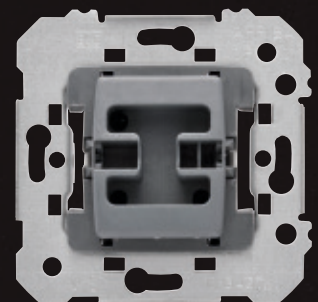

MEC 18

The same mechanism for 5 different designs

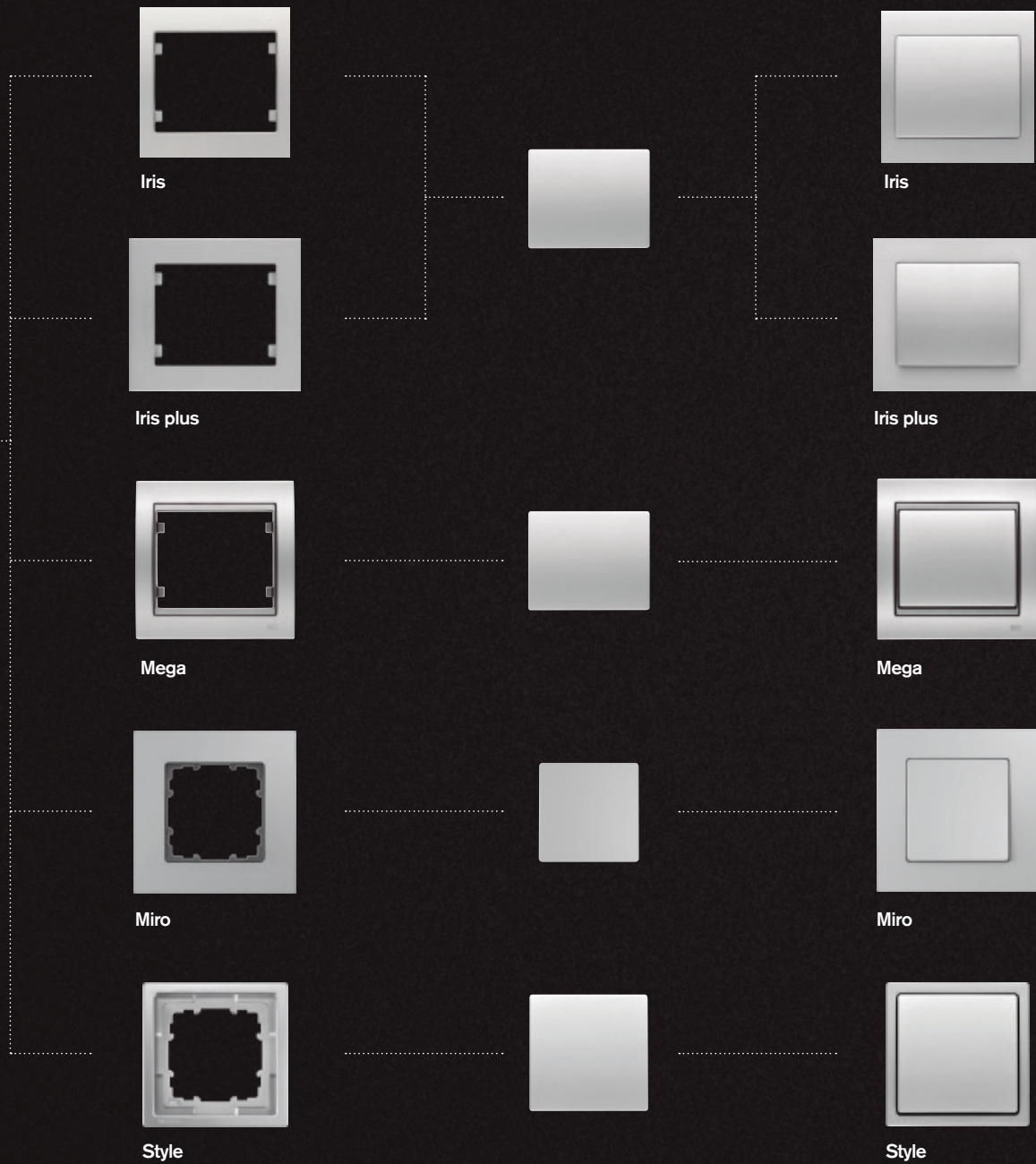

Many different functions

The Style series offers a wide range of functions to cater to today's needs. Light intensity dimmers, sound controllers and blind rolling up and down mechanisms. Choose the options you need, guaranteeing total comfort and enjoy our solutions' colourful and appealing designs.



Dimmers

Dimmers are the perfect element create an atmosphere in rooms by adjusting the lighting levels to the desired intensity. The intensity can be increased or decreased. The power and technology of the different lamps requires using specific dimmers, adapted in each case to adjust the power levels. BJC offers a wide range of dimmers, suitable for different lamps and power ratings.



Chargers with double USB

The Schuko® socket with double USB Type A and Type C allows the simultaneous charging of two terminals while maintaining the usability of the socket. Quick and easy installation in a standard flush-mounted box.

- Power Delivery (required by EU by the end of 2024)
- Quick charge
- For standard flush-mounted box.



Multimedia

The multimedia connectors are the perfect solution to prevent exposed wiring in the installation and for the distribution of electronic devices in any type of installation; whether household or commercial. The HDMI, VGA, RJ45, stereo cable and other outputs can provide separate input and output sources, for efficient connections and uncluttered installations.



LED indicator

Siemens' modular LED indicators are used to indicate: stairs, waiting rooms, interiors, corridors and calls. They are available in three tones of white, green and red. The modular system allows the combination of two beacon lights or two elements, such as a buzzer and LED beacon light, indicating that there is a call; sound and visual.



Smart solutions with KNX

KNX connects a network of functions, including security, climate-control, lighting and multimedia devices. The system's centralised and smart control systems can cater to the needs of each specific case and can be programmed at any time. With a discreet design, Siemens' keyboards allow the installation to be easily and comfortably handled.



Style surface mounting box

The surface mounting box of the Style series can be used in non flush-mounted installations and be fully integrated into the aesthetic characteristics of the series. The cable glands for connections can be used for wiring and terminal strips. They are offered in polar white and platinum metallic finishes and for frames with one, two or three elements.

16 A in Mec switches

The switches feature a powerful 16 A device with automatic terminal connection, with an ergonomic design for comfortable, easy and safe handling.



Mechanism

Mec 18 mechanism, which can be adapted to Iris, Iris plus, Mega and Siemens products for your comfort.



Frame

Compact space between the frame and switch. High-quality finishes.



Switch

Accurate operation. Smooth and comfortable to the touch.

Table for composing basic functions - Style

	● Polar White		● Platinum Metallic		● Anthracite Cosso		● Chocolate		● Malt Gold	
Function	Mechanism	Switch/Cover	Mechanism	Switch/Cover	Mechanism	Switch/Cover	Mechanism	Switch/Cover	Mechanism	Switch/Cover
One-way switch	18505	5TG72705WH00	18505	5TG72705PM00	18505	5TG72705AC00	18505	5TG72705CH00	18505	5TG72705MG00
Two-way switch	18506	5TG72705WH00	18506	5TG72705PM00	18506	5TG72705AC00	18506	5TG72705CH00	18506	5TG72705MG00
Intermediate switch	18507	5TG72705WH00	18507	5TG72705PM00	18507	5TG72705AC00	18507	5TG72705CH00	18507	5TG72705MG00
Double one-way switch	18509	5TG72701WH00	18509	5TG72701PM00	18509	5TG72701AC00	18509	5TG72701CH00	18509	5TG72701MG00
Double two-way switch	18510	5TG72701WH00	18510	5TG72701PM00	18510	5TG72701AC00	18510	5TG72701CH00	18510	5TG72701MG00
Bell push-button	18516	5TG72705WH10	18516	5TG72705PM10	18516	5TG72705AC10	18516	5TG72705CH10	18516	5TG72705MG10
Bulb push-button	18516	5TG72705WH20	18516	5TG72705PM20	18516	5TG72705AC20	18516	5TG72705CH20	18516	5TG72705MG20
Dimmer	21549-X	5TC89120WH	21549-X	5TC89120PM	21549-X	5TC89120AC	21549-X	5TC89120CH	21549-X	5TC89120MG
Schuko® socket	18524	5UH12724WH	18524	5UH12724PM	18524	5UH12724AC	18524	5UH12724CH	18524	5UH12724MG
Schuko® + double USB Type A and Type C	18524-USBC	5UH12725WH10	18524-USBC	5UH12725PM10	18524-USBC	5UH12725AC10	18524-USBC	5UH12725CH10	18524-USBC	5UH12725MG10
TV/FM socket outlet	5TG13380WH		5TG13381		5TG13380AC		5TG13380CH		5TG13380MG	
Adapter for 1 RJ connector	19582-1	5TG22782WH01	19582-1	5TG22782PM01	19582-1	5TG22782AC01	19582-1	5TG22782CH01	19582-1	5TG22782MG01
Adapter for 2 RJ connectors	19682-1	5TG22782WH02	19682-1	5TG22782PM02	19682-1	5TG22782AC02	19682-1	5TG22782CH02	19682-1	5TG22782MG02
Blank cover	5TG13300WH		5TG13301		5TG13300AC		5TG13300CH		5TG13300MG	
Cable output	5TG13350WH		5TG13351		5TG13350AC		5TG13350CH		5TG13350MG	
Buzzer	5TG98758WH	5TG13910WH	5TG98758PM	5TG13911	5TG98758CM	5TG13910AC	5TG98758CM	5TG13910CH	5TG98758CM	5TG13910MG
Key card switch	5TG48300WH		5TG48301		5TG48300AC		5TG48300CH		5TG48300MG	
Frame	5TG13210WH		5TG13211		5TG13210AC		5TG13210CH		5TG13210MG	

Switches

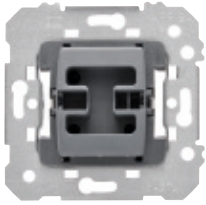

One-way switch **18505***
Two-way switch **18506***
 16 A 250 V~
Intermediate switch **18507***
 10 A 250 V~

Packing 10

		ROCKER				
		POLAR WHITE 5TG7270-5WH00	PLATINUM M. 5TG7270-5PM00	ANTHRACITE C. 5TG7270-5AC00	CHOCOLATE 5TG7270-5CH00	MALT GOLD 5TG7270-5MG00
Equivalent ref.		61705-WH	61705-PM	61705-AC	61705-CH	61705-DM
Packing		10	2	2	2	2
		ROCKER WITH LENS				
		POLAR WHITE 5TG7270-5WH01	PLATINUM M. 5TG7270-5PM01	ANTHRACITE C. 5TG7270-5AC01	CHOCOLATE 5TG7270-5CH01	MALT GOLD 5TG7270-5MG01
Equivalent ref.		61705-WHL	61705-PML	61705-ACL	61705-CHL	61705-DML
Packing		10	2	2	2	2

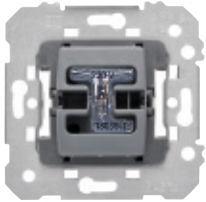

One-way switch with control light **18605***
Two-way switch with control light **18606***
Two-way switch with
18506-L*
indicator light
 16 A 250 V~

Packing 10

Neon lamp incorporated in reference 18506-L

		ROCKER WITH LENS				
		POLAR WHITE 5TG7270-5WH01	PLATINUM M. 5TG7270-5PM01	ANTHRACITE C. 5TG7270-5AC01	CHOCOLATE 5TG7270-5CH01	MALT GOLD 5TG7270-5MG01
Equivalent ref.		61705-WHL	61705-PML	61705-ACL	61705-CHL	61705-DML
Packing		10	2	2	2	2

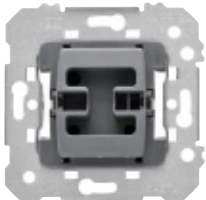

2 pole one-way switch **18508***
2 pole one-way switch
18608*
with control light
 16 A 250 V~
 Only rockers with indicator light

Packing 10

Neon lamp incorporated in reference 18608

		ROCKER WITH I/O SYMBOLS				
		POLAR WHITE 5TG7270-5WH40	PLATINUM M. 5TG7270-5PM40	ANTHRACITE C. 5TG7270-5AC40	CHOCOLATE 5TG7270-5CH40	MALT GOLD 5TG7270-5MG40
Equivalent ref.		61708-WH	61708-PM	61708-AC	61708-CH	61708-DM
Packing		2	2	2	2	2
		ROCKER WITH I/O SYMBOLS AND LENS				
		POLAR WHITE 5TG7270-5WH41	PLATINUM M. 5TG7270-5PM41	ANTHRACITE C. 5TG7270-5AC41	CHOCOLATE 5TG7270-5CH41	MALT GOLD 5TG7270-5MG41
Equivalent ref.		61708-WHL	61708-PML	61708-ACL	61708-CHL	61708-DML
Packing		2	2	2	2	2

* The Siemens Miro and Style series are compatible with inserts manufactured from January 2017 onwards.

Note: Equivalent ref. is a valid reference for order entering (also available on the product package labelling).

Double Switches / push-buttons

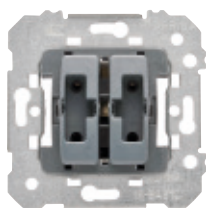

Double one-way switch **18509***
Double two-way switch **18510***
 16 A 250 V~
Double push-button **18511***
 10 A 250 V~
Double push-button, normally-closed **18513***
 10 A 250 V~

Packing 10

DOUBLE ROCKER



POLAR WHITE 5TG7270-1WH00 61709-WH	PLATINUM M. 5TG7270-1PM00 61709-PM	ANTHRACITE C. 5TG7270-1AC00 61709-AC	CHOCOLATE 5TG7270-1CH00 61709-CH	MALT GOLD 5TG7270-1MG00 61709-DM
Equivalent.ref. Packing	10 2	2 2	2 2	2 2

DOUBLE ROCKER WITH LENS

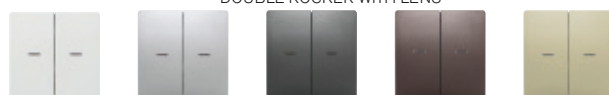

POLAR WHITE 5TG7270-1WH01 61709-WHL	PLATINUM M. 5TG7270-1PM01 61709-PML	ANTHRACITE C. 5TG7270-1AC01 61709-ACL	CHOCOLATE 5TG7270-1CH01 61709-CHL	MALT GOLD 5TG7270-1MG01 61709-DML
Equivalent.ref. Packing	10 2	2 2	2 2	2 2

Double push-button with lamp **18511-L***
 10 A 250 V~

Packing 10

Neon lamp incorporated in reference
 18511-L

DOUBLE ROCKER WITH LENS



POLAR WHITE 5TG7270-1WH01 61709-WHL	PLATINUM M. 5TG7270-1PM01 61709-PML	ANTHRACITE C. 5TG7270-1AC01 61709-ACL	CHOCOLATE 5TG7270-1CH01 61709-CHL	MALT GOLD 5TG7270-1MG01 61709-DML
Equivalent.ref. Packing	10 2	2 2	2 2	2 2

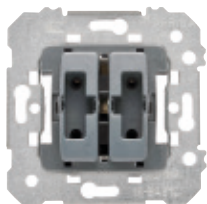

Two-way switch + Push-button **18515***
 16 A + 10 A 250 V~

Packing 10

DOUBLE ROCKER FOR PUSH-BUTTON WITH BELL SYMBOL



POLAR WHITE 5TG7270-1WH10 61715-WH	PLATINUM M. 5TG7270-1PM10 61715-PM	ANTHRACITE C. 5TG7270-1AC10 61715-AC	CHOCOLATE 5TG7270-1CH10 61715-CH	MALT GOLD 5TG7270-1MG10 61715-DM
Equivalent.ref. Packing	2 2	2 2	2 2	2 2

* The Siemens Miro and Style series are compatible with inserts manufactured from January 2017 onwards.

Note: Equivalent ref. is a valid reference for order entering (also available on the product package labelling).

Push-buttons

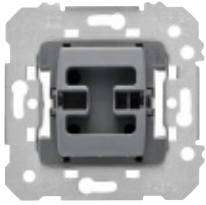

Push-button, normally-open
Push-button, normally-closed
 10 A 250 V~

Packing 10

Note:
 Pictograms can be added
 on request



18516*

18512*

Equivalent ref.
 Packing



POLAR WHITE
5TG7270-5WH10

61716-WH
 10



PLATINUM M.
5TG7270-5PM10

61716-PM
 2



ANTHRACITE C.
5TG7270-5AC10

61716-AC
 2



CHOCOLATE
5TG7270-5CH10

61716-CH
 2



MALT GOLD
5TG7270-5MG10

61716-DM
 2

ROCKER WITH BELL SYMBOL

Equivalent ref.
 Packing



POLAR WHITE
5TG7270-5WH11

61716-WHL
 10



PLATINUM M.
5TG7270-5PM11

61716-PML
 2



ANTHRACITE C.
5TG7270-5AC11

61716-ACL
 2



CHOCOLATE
5TG7270-5CH11

61716-CHL
 2



MALT GOLD
5TG7270-5MG11

61716-DML
 2

ROCKER WITH LENS AND BELL SYMBOL

Equivalent ref.
 Packing



POLAR WHITE
5TG7270-5WH20

61717-WH
 10



PLATINUM M.
5TG7270-5PM20

61717-PM
 2



ANTHRACITE C.
5TG7270-5AC20

61717-AC
 2



CHOCOLATE
5TG7270-5CH20

61717-CH
 2



MALT GOLD
5TG7270-5MG20

61717-DM
 2

ROCKER WITH BULB SYMBOL

Equivalent ref.
 Packing



POLAR WHITE
5TG7270-5WH21

61717-WHL
 10



PLATINUM M.
5TG7270-5PM21

61717-PML
 2



ANTHRACITE C.
5TG7270-5AC21

61717-ACL
 2



CHOCOLATE
5TG7270-5CH21

61717-CHL
 2



MALT GOLD
5TG7270-5MG21

61717-DML
 2

ROCKER WITH LENS AND BULB SYMBOL

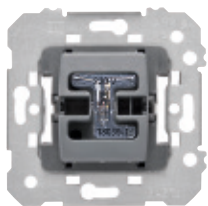

**Push-button with timed
 switch and indicator light**

Power supply voltage: 230V~ 50Hz
 Consumption: 5VA

Loads:

- Incandescent and halogen 230V:
 40 - 400W
- Halogen lamps with ferromagnetic
 transformer: 50 - 320W
- Halogen lamps with electronic transformer:
 40 - 400W
- Motors: 36-100W/10 min.

Time adjustable from 30s to 10min

Packing 1

18599*

Equivalent ref.
 Packing



POLAR WHITE
5TG7270-5WH21

61717-WHL
 10



PLATINUM M.
5TG7270-5PM21

61717-PML
 2



ANTHRACITE C.
5TG7270-5AC21

61717-ACL
 2



CHOCOLATE
5TG7270-5CH21

61717-CHL
 2



MALT GOLD
5TG7270-5MG21

61717-DML
 2

ROCKER WITH LIGHT INDICATOR WITH LOGO LAMP

* The Siemens Miro and Style series are compatible with inserts manufactured from January 2017 onwards.

Note: Equivalent ref. is a valid reference for order entering (also available on the product package labelling).

Electronic timer switch



Adjustable electronic timer switch **2382**

Power supply voltage: 230V~ 50Hz

Consumption: 5VA

Loads:

- Incandescent and halogen 230V: 40 - 400W
- Halogen lamps with ferromagnetic transformer: 50 - 320W
- Halogen lamps with electronic transformer: 40 - 400W
- Motors: 36-100W

Time adjustable from 30s to 10 min

Packing 1





Note:
Pictograms can be added
on request



Key card switches

Key card switch with indicator light

Mechanical operation via insertion of cards
For cards up to 54x65 mm and 0.7-1.0 mm thick
Includes mini white LED lamp (5TG7354)

	KEY CARD SWITCH				
					
	POLAR WHITE 5TG4830-0WH 61068-WH	PLATINUM M. 5TG4830-1 61068-PM	ANTHRACITE C. 5TG4830-0AC 61068-AC	CHOCOLATE 5TG4830-0CH 61068-CH	MALT GOLD 5TG4830-0MG 61068-DM
Equivalent ref.					
Packing	1	1	1	1	1

Indicator lights



Blue LED indicator light **18039-1AZ**
230 V~
Indicator light for 2 pole one-way switches
and single pole one-way switches with control light
Wide rocker

Packing 18039-1AZ = 5



Blue LED indicator light **18039-2AZ**
230 V~
Indicator lights for one-way switches, two-way switches,
intermediate switches and push-buttons.
Wide rocker

Packing 18039-2AZ = 10



Blue LED indicator light **18039-3AZ**
230 V~
Indicator lights for all different kind of inserts
Narrow rocker

Packing 18039-3AZ = 10



Load for indicator lights with energy saving and fluorescent lamps **3139**

Packing 1

Insert for blinds

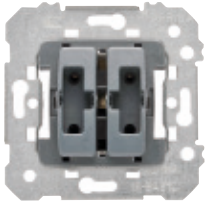

Double push-button for blinds

18565*

Double switch for blinds

18569*

With electrical and mechanical interlocking device
10 A 250 V~

Packing 10

Double push-button for blinds

18511*

Suitable for connecting any blind control device
No interlocking device
10 A 250 V~

Packing 10

* The Siemens Miro and Style series are compatible with inserts manufactured from January 2017 onwards.

DOUBLE ROCKER FOR BLINDS



POLAR WHITE

5TG7276-5WH00

61765-WH

10

PLATINUM M.

5TG7276-5PM00

61765-PM

2

ANTHRACITE C.

5TG7276-5AC00

61765-AC

2

CHOCOLATE

5TG7276-5CH00

61765-CH

2

MALT GOLD

5TG7276-5MG00

61765-DM

2

Equivalent.ref.
Packing



Blind control to be installed in a flush-mounting box

5TC1272

Blinds controller for 230 V motors
Max power: 1250 VA
Local or centralised operating
Drive time adjustable from 1 to 120 sec.

Packing 1

Note: Equivalent ref. is a valid reference for order entering (also available on the product package labelling)

Dimmers



Two-way dimmer for RL loads (60 to 600 W) **21539-X**
 Two-way dimmer for incandescent (R), direct halogen (R) 60-600 W and halogen 12 V low voltage with ferromagnetic transformer (L) 25-500 VA.
 Fuse T 4 H 250 V
 Switch on / off by pressing
 Screw or claw fixing

Packing 1

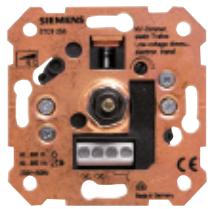

Two-way dimmer for RC loads (60 to 800 W) **21542-X**
 Two-way dimmer for incandescent (R), direct halogen (R) 60-800 W and low voltage halogens with electronic transformer (C) 20 to -800 VA
 Switch on / off by pressing
 Screw or claw fixing
 Electronic protection against short circuits

Packing 1



Electronic potentiometer for fluorescent lamps **21543-X**
 1 to 10 Vdc
 Potentiometer for fluorescent lamps with adjustable electronic ballast 920 VA, 50 mA (10 VDC)
 Maximum control current: 50 mA. 230 V, 4 A
 Fuse T 4 H 250 V
 Switch on / off by pressing. Screw or claw fixing

Packing 1



Two-way dimmer for LED lamps 230 Vac **21549-X**
 LED Lamps 6-60 W. incandescent, direct halogen (R) 6-120 W halogen 12 V low voltage with ferromagnetic transformer (L) 25-100 VA.
 Switch on / off by pressing
 1.6 Fuse T H 250 V.
 Screw or claw fixing
 List of compatibility-tested LED lamps is available at: www.bjc.es/ documentacion

Packing 1



	COVER AND BUTTON				
	POLAR WHITE	PLATINUM M.	ANTHRACITE C.	CHOCOLATE	MALT GOLD
	5TC8912-0WH	5TC8912-0PM	5TC8912-0AC	5TC8912-0CH	5TC8912-0MG
Equivalent.ref.	61749-WH	61749-PM	61749-AC	61749-CH	61749-DM
Packing	1	1	1	1	1

Note: Equivalent ref. is a valid reference for order entering (also available on the product package labelling).

Dimmers



Universal RLC dimmer

2385

Power supply voltage: 230V~ 50Hz.
Consumption: 3VA.
Loads:
• Incandescent and halogen lamps (230V): 15 - 400W.
• Halogen Lamps with inductive transformer: 20 - 250W.
• Halogen lamps with electronic transformer: 15 - 400W.

Packing 1



Dimmer for LED lamps

2386

Power supply voltage: 230V~ 50/60Hz.
Consumption: 2VA.
Valid for adjustable LED lamps:
• to 230V~: 4-100W
• To 12V~ with adjustable electronic transformer (1 lamp/ transformer): maximum 6 transformers (50W).

Packing 1



Dimmer for LED strip, monochrome (12-48 Vdc)

2387

Power supply voltage: 12 - 48V CC.
Consumption: <12mA.
Maximum Load 8A.
Minimum regulation level: 1% - 60%.
Regulation speed 0% to 100%: 3 - 10 s.

Packing 1



Dimmer for adjustable compact fluorescent lamps

2388

Power supply voltage: 230V~ 50Hz.
Consumption: 3VA.
Load: min.20 - Max.200W.

Packing 1

Load connection

LOAD TYPE								
21539-X	Rotary	60-600 W	25-500 VA	NO	NO	NO	NO	NO
21542-X	Rotary	60-800 W	NO	60-800 VA	NO	NO	NO	NO
21543-X	Rotary	NO	NO	NO	NO	NO	NO	920 VA 50 mA (10 Vdc)
21549-X	Rotary	6-120 W	25-100 VA	NO	6-60 W	NO	NO	NO
2385	By push-button	15-400 W	20-250 VA	15-400 VA	NO	NO	NO	NO
2386	By push-button	NO	NO	4-300 W	4-100 W	NO	NO	NO
2387 *	By push-button	NO	NO	NO	NO	Maximum 8 A	NO	NO
2388	By push-button	NO	NO	NO	NO	NO	20 W - 200 W	NO

* 2387. The dimmer must be installed along with the 230Vac 12-48Vdc transformer that carries the LED strip. A list of compatibility-tested LED lamps is available at www.bjc.es/documentation

Socket outlets with increased touch protection

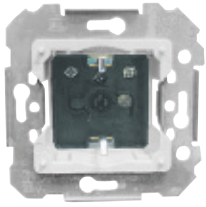

Schuko® socket outlet with increased touch protection **18524**
Screwed terminals
16 A 250 V~

Packing 10

SOCKET OUTLET COVER



	POLAR WHITE 5UH1272-4WH 61724-WH	PLATINUM M. 5UH1272-4PM 61724-PM	ANTHRACITE C. 5UH1272-4AC 61724-AC	CHOCOLATE 5UH1272-4CH 61724-CH	MALT GOLD 5UH1272-4MG 61724-DM
Equivalent ref.					
Packing	10	2	2	2	2



Schuko® socket outlet 2P+E with double USB type A and type C charger with fast charging with increased touch protection **18524-USBC** **NEW**

Schuko® socket:
- 230Vac 50Hz, 16A
- Screwless terminal
Double USB charger:
- 1 USB Type A socket and 1 USB Type C socket
- Maximum power: 20W
- Quick charge Power Delivery USB C: 5V/3A; 9V/2.22A; 12V/1.67A
- Quick charge USB A fast charging: 5V/3A; 9V/2.22A; 12V/1.67A
- Normal charging:
- 5V/3.4A when using USB A and USB C at the same time
- 5V/2.4A when using USB A or USB C individually
- Short circuit protection
- Temperature protection
According to UNE 20315-1-1/1-1-2 and EN 62368-1 standards

Packing 1

STYLE TAPA SCHUKO CON PROTECCION SEGURIDAD



	POLAR WHITE 5UH1272-5WH10 61724-USBC-WH	PLATINUM M. 5UH1272-5PM10 61724-USBC-PM	ANTHRACITE C. 5UH1272-5AC10 61724-USBC-AC	CHOCOLATE 5UH1272-5CH10 61724-USBC-CH	MALT GOLD 5UH1272-5MG10 61724-USBC-DM
Equivalent ref.	1	1	1	1	1
Packing	NEW	NEW	NEW	NEW	NEW

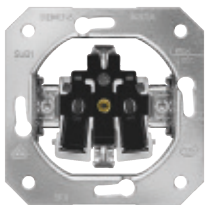

Schuko® socket outlet with screw-less terminals with claws **5UB1101-5B**

Schuko® socket outlet with screw-less terminals without claws **5UB1101-5KK**

For flexible or rigid 2.5mm cable

Packing 10

STYLE SCHUKO® SOCKET OUTLET COVER



	POLAR WHITE 5UH1273-2WH 61732-WH	PLATINUM M. 5UH1273-2PM 61732-PM	ANTHRACITE C. 5UH1273-2AC 61732-AC	CHOCOLATE 5UH1273-2CH 61732-CH	MALT GOLD 5UH1273-2MG 61732-DM	RED 5UH1273-2RD 61732-RD
Equivalent ref.						
Packing	10	2	2	2	2	1

STYLE SCHUKO® SOCKET OUTLET COVER WITH LABELLING FIELD



	POLAR WHITE 5UH1273-2WH01	PLATINUM M. 5UH1273-2PM01	ANTHRACITE C. 5UH1273-2AC01	CHOCOLATE 5UH1273-2CH01	MALT GOLD 5UH1273-2MG01	RED 5UH1273-2RD01
Equivalent ref.	-	-	-	-	-	-
Packing	1	1	1	1	1	1

SSTYLE SCHUKO® SOCKET OUTLET COVER WITH LABELLING FIELD AND OPERATING INDICATOR



	POLAR WHITE 5UH1273-2WH11	PLATINUM M. 5UH1273-2PM11	ANTHRACITE C. 5UH1273-2AC11	CHOCOLATE 5UH1273-2CH11	MALT GOLD 5UH1273-2MG11
Equivalent ref.	-	-	-	-	-
Packing	1	1	1	1	1

STYLE SCHUKO® SOCKET OUTLET COVER WITH LABELLING FIELD AND OVERVOLTAGE PROTECTION MODULE (5UH1300) SUPPLIED SEPARATELY



	POLAR WHITE 5UH1273-2WH21	PLATINUM M. 5UH1273-2PM21	ANTHRACITE C. 5UH1273-2AC21	CHOCOLATE 5UH1273-2CH21	MALT GOLD 5UH1273-2MG21
Equivalent ref.	-	-	-	-	-
Packing	1	1	1	1	1

Note: Equivalent ref. is a valid reference for order entering (also available on the product package labelling).

Socket outlets with increased touch protection

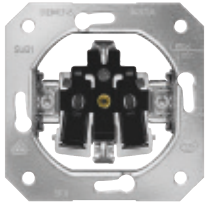

Schuko® socket outlet with 5UB1101-5B screw-less terminals with claws
Schuko® socket outlet with 5UB1101-5KK screw-less terminals without claws
 For flexible or rigid 2.5mm cable
 Packing 10

Equivalent ref.
Packing

STYLE SCHUKO® SOCKET OUTLET COVER WITH HINGED LID



POLAR WHITE 5UH1288-4WH 61814-WH	PLATINUM M. 5UH1288-4PM 61814-PM	ANTHRACITE C. 5UH1288-4AC 61814-AC	CHOCOLATE 5UH1288-4CH 61814-CH	MALT GOLD 5UH1288-4MG 61814-DM
1	1	1	1	1

STYLE SCHUKO® SOCKET OUTLET COVER WITH HINGED LID AND LABELLING FIELD



Equivalent ref.
Packing

POLAR WHITE 5UH1288-4WH01	PLATINUM M. 5UH1288-4PM01	ANTHRACITE C. 5UH1288-4AC01	CHOCOLATE 5UH1288-4CH01	MALT GOLD 5UH1288-4MG01
-	-	-	-	-
1	1	1	1	1

STYLE SCHUKO® SOCKET OUTLET COVER WITH LABELLING FIELD AND OPERATING INDICATOR



Equivalent ref.
Packing

POLAR WHITE 5UH1288-4WH11	PLATINUM M. 5UH1288-4PM11	ANTHRACITE C. 5UH1288-4AC11	CHOCOLATE 5UH1288-4CH11	MALT GOLD 5UH1288-4MG11
-	-	-	-	-
1	1	1	1	1



IP 44 sealing kit 5TG4318 for Schuko® socket outlets with hinged lid
 Miro and Style

Packing 1



Lamp for Schuko® socket outlet with operating indicator 5TG7304
 1,5 mA, 230 V AC/ 50 Hz

Packing 1



Spare part overvoltage protection 5UH1300 module for Schuko® socket outlets with overvoltage protection

Packing 1

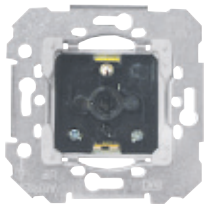

2 pole with socket outlet earth pin 18572 (French/Belgian standard) with increased touch protection
 Screwed terminals 16 A 250 V~

Packing 10

Equivalent ref.
Packing

SOCKET OUTLET COVER FOR FRENCH/BELGIAN STANDARD



POLAR WHITE 5UH1277-2WH 61772-WH	PLATINUM M. 5UH1277-2PM 61772-PM	ANTHRACITE C. 5UH1277-2AC 61772-AC	CHOCOLATE 5UH1277-2CH 61772-CH	MALT GOLD 5UH1277-2MG 61772-DM
10	2	2	2	2

Note: Equivalent ref. is a valid reference for order entering (also available on the product package labelling).

IP44 switch solutions

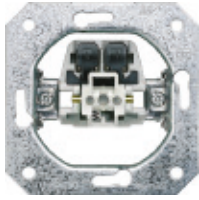

One-way switch **5TA2151**
Two-way switch 16A **5TA2156**
Intermediate switch **5TA2117**
Pushbutton, 1 NO contact **5TD2120**
Pushbutton, 1 CO contact **5TD2123**

Packing 1

For IP44 protection use of seal 5TG4324 is needed.

Packing

ROCKER



POLAR WHITE 5TG7141-0WH00	PLATINUM M. 5TG7141-1	ANTHRACITE C. 5TG7141-0AC00	CHOCOLATE 5TG7141-0CH00	MALT GOLD 5TG7141-0MG00
1	1	1	1	1

These rockers are only suitable for IP44 (together with the corresponding seal) being used with the above indicated inserts. They are not suitable for MEC18 inserts

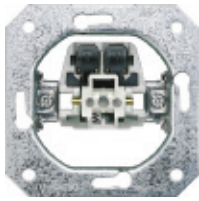

Pushbutton, 1 NO contact **5TD2120**
Pushbutton, 1 CO contact **5TD2123**

Packing 1

For IP44 protection use of seal 5TG4324 is needed.

Bell logo
 Packing

Bulb logo
 Packing

Bulb logo and lens
 Packing

ROCKER WITH BELL SYMBOL



POLAR WHITE 5TG7141-0WH10	PLATINUM M. 5TG7144-1	ANTHRACITE C. 5TG7141-0AC10	CHOCOLATE 5TG7141-0CH10	MALT GOLD 5TG7141-0MG10
1	1	1	1	1
5TG7141-0WH20	5TG7141-0PM20	5TG7141-0AC20	5TG7141-0CH20	5TG7141-0MG20
1	1	1	1	1
5TG7141-0WH21	5TG7146-1	5TG7141-0AC21	5TG7141-0CH21	5TG7141-0MG21
1	1	1	1	1

These rockers are only suitable for IP44 (together with the corresponding seal) being used with the above indicated inserts. They are not suitable for MEC18 inserts

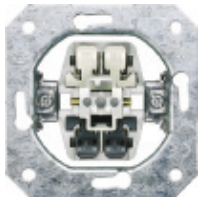

ON/OFF switch, 2-pole, 10 A **5TA2112**
ON/OFF switch, 2-pole, 16 A **5TA2162**
ON/OFF switch, 3-pole, 16 A **5TA2153**

Packing 1

For IP44 protection use of seal 5TG4324 is needed.

Packing

ROCKER WITH I/O SYMBOLS



POLAR WHITE 5TG7145-0WH40	PLATINUM M. 5TG7142-1	ANTHRACITE C. 5TG7141-0AC40	CHOCOLATE 5TG7141-0CH40	MALT GOLD 5TG7141-0MG40
1	1	1	1	1

These rockers are only suitable for IP44 (together with the corresponding seal) being used with the above indicated inserts. They are not suitable for MEC18 inserts

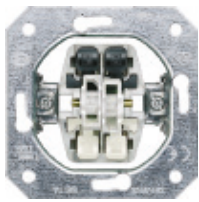

Two-circuit switch **5TA2155**
Double two-way switch **5TA2118**
Pushbutton, double, 1 NO contact, 1 CO contact **5TD2115**
Pushbutton, double, 2 NO contacts **5TD2111**

Packing 1

For IP44 protection use of seal 5TG4324 is needed.

Packing

DOUBLE ROCKER



POLAR WHITE 5TG7145-0WH00	PLATINUM M. 5TG7145-1	ANTHRACITE C. 5TG7145-0AC00	CHOCOLATE 5TG7145-0CH00	MALT GOLD 5TG7145-0MG00
1	1	1	1	1

These rockers are only suitable for IP44 (together with the corresponding seal) being used with the above indicated inserts. They are not suitable for MEC18 inserts

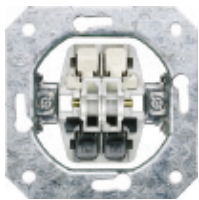

Shutter/blind switch, with electrical and mechanical interlock **5TA2154**
Shutter/blind pushbutton, with electrical interlock **5TA2114**

Packing 1

For IP44 protection use of seal 5TG4324 is needed.

Packing

DOUBLE ROCKER FOR BLINDS



POLAR WHITE 5TG7143-0WH00	PLATINUM M. 5TG7143-1	ANTHRACITE C. 5TG7143-0AC00	CHOCOLATE 5TG7143-0CH00	MALT GOLD 5TG7143-0MG00
1	1	1	1	1

These rockers are only suitable for IP44 (together with the corresponding seal) being used with the above indicated inserts. They are not suitable for MEC18 inserts



IP44 set of seals, for inserts **5TG4324**

Suitable for use only in conjunction with inserts and rockers in this page.

Packing 1

IP44 socket outlet solutions

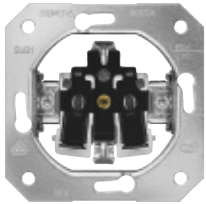

Schuko® socket outlet with **5UB1101-5B**
screw-less terminals with claws

Schuko® socket outlet with **5UB1101-5KK**
screw-less terminals without claws

For flexible or rigid 2.5mm cable
Packing 10

STYLE SCHUKO® SOCKET OUTLET COVER WITH HINGED LID



	POLAR WHITE	PLATINUM M.	ANTHRACITE C.	CHOCOLATE	MALT GOLD
Equivalent ref.	5UH1288-4WH	5UH1288-4PM	5UH1288-4AC	5UH1288-4CH	5UH1288-4MG
Packing	61814-WH 1	61814-PM 1	61814-AC 1	61814-CH 1	61814-DM 1

STYLE SCHUKO® SOCKET OUTLET COVER WITH HINGED LID AND LABELLING FIELD



	POLAR WHITE	PLATINUM M.	ANTHRACITE C.	CHOCOLATE	MALT GOLD
Equivalent ref.	5UH1288-4WH01	5UH1288-4PM01	5UH1288-4AC01	5UH1288-4CH01	5UH1288-4MG01
Packing	- 1	- 1	- 1	- 1	- 1

STYLE SCHUKO® SOCKET OUTLET COVER WITH LABELLING FIELD AND OPERATING INDICATOR



	POLAR WHITE	PLATINUM M.	ANTHRACITE C.	CHOCOLATE	MALT GOLD
Equivalent ref.	5UH1288-4WH11	5UH1288-4PM11	5UH1288-4AC11	5UH1288-4CH11	5UH1288-4MG11
Packing	- 1	- 1	- 1	- 1	- 1



IP44 sealing kit **5TG4318**
for Schuko® socket outlets with hinged lid

Miro and Style

Packing 1

Note: Equivalent ref. is a valid reference for order entering (also available on the product package labelling).

TV-FM-R/TV-SAT Socket outlets

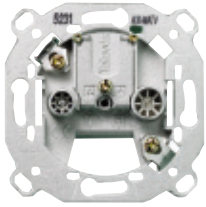

TV-FM socket outlet
Series 2-10 **2932**
Final outlet **2933**
Individual installation **2934**
 (Manufacturer TELEVÉS)

Packing 10
 TV-FM socket outlets are according to UNE 20523 and CEI 169-2 standards

Equivalent ref.
 Packing

TAPA TV-FM-R/TV-SAT 2/3 OUTPUTS



Color	Model	Equivalent ref.	Packing
POLAR WHITE	5TG1338-0WH	61330-WH	10
PLATINUM M.	5TG1338-1	61330-PM	1
ANTHRACITE C.	5TG1338-0AC	61330-AC	2
CHOCOLATE	5TG1338-0CH	61330-CH	2
MALT GOLD	5TG1338-0MG	61330-DM	2

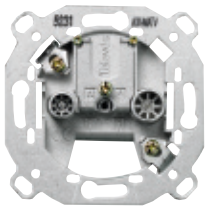

R/TV-SAT socket with 2 outlets
Series 6-12 **2921**
Series 2-5 **2922**
Final outlet **2923**
Individual installation **2924**
 (Manufacturer TELEVÉS)

Packing 10
 R/TV-SAT socket outlets are according to UNE 20523 and CEI 169-2 standards

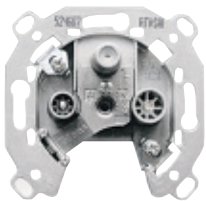

R/TV-SAT socket with 3 outlets **2918**
Individual installation
 (Manufacturer TELEVÉS)

Packing 1
 R/TV-SAT socket outlets conform to UNE-20523 and CEI 169-2 standards

Note: Equivalent ref. is a valid reference for order entering (also available on the product package labelling).

Voice and Data connectors and adapters, Type RJ

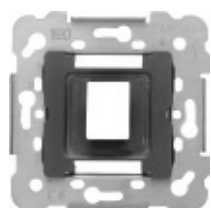

Adapter for 1 RJ45/RJ11 connector (AMP, ITT, etc.) **19582-1**

Packing 10

COVERS FOR 1 RJ CONNECTOR OR FIBRE

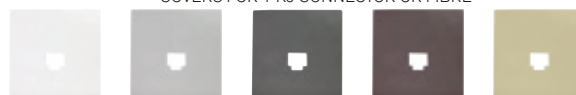

Equivalent ref.
Packing

POLAR WHITE	PLATINUM M.	ANTHRACITE C.	CHOCOLATE	MALT GOLD
5TG2278-2WH01	5TG2278-2PM01	5TG2278-2AC01	5TG2278-2CH01	5TG2278-2MG01
61782-WH	61782-PM	61782-AC	61782-CH	61782-DM
10	1	1	1	1

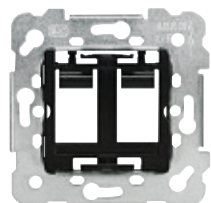

Adapter for 2 RJ11/RJ45 connectors **19682-1**

Packing 10

COVERS FOR DOUBLE RJ CONNECTOR OR FIBRE



Equivalent ref.
Packing

POLAR WHITE	PLATINUM M.	ANTHRACITE C.	CHOCOLATE	MALT GOLD
5TG2278-2WH02	5TG2278-2PM02	5TG2278-2AC02	5TG2278-2CH02	5TG2278-2MG02
61882-WH	61882-PM	61882-AC	61882-CH	61882-DM
1	1	1	1	1



Keystone RJ45 connector Cat 6 **3186-B**

Cat. 6
White

Packing 25

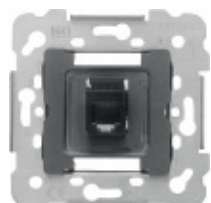

Adapter with RJ11 connector **19582**

Tool-less connection

Packing 10

COVERS FOR 1 RJ CONNECTOR OR FIBRE



Equivalent ref.
Packing

POLAR WHITE	PLATINUM M.	ANTHRACITE C.	CHOCOLATE	MALT GOLD
5TG2278-2WH01	5TG2278-2PM01	5TG2278-2AC01	5TG2278-2CH01	5TG2278-2MG01
61782-WH	61782-PM	61782-AC	61782-CH	61782-DM
10	1	1	1	1

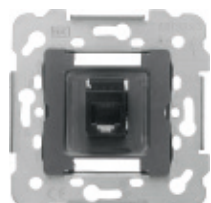

Adapter with RJ45 connector Cat 5E (ISO 8877) **19595**

Packing 10

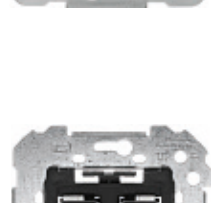

Adapter with RJ45 connector Cat 6 **18586**

Tool-less connection

Packing 10

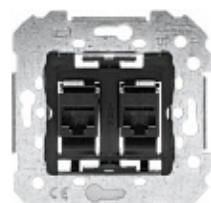

Adapter with 2 RJ45 connectors Cat 6 **18586-2**

Tool-less connection

Packing 1

COVERS FOR DOUBLE RJ CONNECTOR OR FIBRE



Equivalent ref.
Packing

POLAR WHITE	PLATINUM M.	ANTHRACITE C.	CHOCOLATE	MALT GOLD
5TG2278-2WH02	5TG2278-2PM02	5TG2278-2AC02	5TG2278-2CH02	5TG2278-2MG02
61882-WH	61882-PM	61882-AC	61882-CH	61882-DM
1	1	1	1	1

Note: Equivalent ref. is a valid reference for order entering (also available on the product package labelling).

SC/APC fiber optic solutions

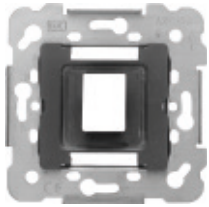

Adapter for 1 RJ connector standart Keystone **19582-1**

Packing 10

COVERS FOR 1 RJ CONNECTOR OR FIBRE



	POLAR WHITE	PLATINUM M.	ANTHRACITE C.	CHOCOLATE	MALT GOLD
Equivalent.ref.	5TG2278-2WH01	5TG2278-2PM01	5TG2278-2AC01	5TG2278-2CH01	5TG2278-2MG01
Packing	61782-WH 10	61782-PM 1	61782-AC 1	61782-CH 1	61782-DM 1

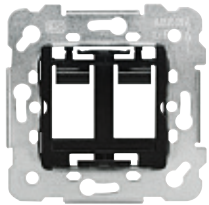

Adapter for 2 RJ connectors standart Keystone **19682-1**

Packing 10

COVERS FOR DOUBLE RJ CONNECTOR OR FIBRE



	POLAR WHITE	PLATINUM M.	ANTHRACITE C.	CHOCOLATE	MALT GOLD
Equivalent.ref.	5TG2278-2WH02	5TG2278-2PM02	5TG2278-2AC02	5TG2278-2CH02	5TG2278-2MG02
Packing	61882-WH 1	61882-PM 1	61882-AC 1	61882-CH 1	61882-DM 1



Coupler for optical fibre connector Type SC/APC **3191**

To be used with adapter 3190 or directly plugged in the RJ cover.
To be installed in increased depth flush-mounting box in order to respect the minimum bending radius of the fibre optic according to norm

Packing 20



Keystone adapter to be used with the coupler 3191 in RJ adapters **3190**

For a proper use of this adapter an increased depth flush-mounting box is recommended.

Packing 20

Note: Equivalent ref. is a valid reference for order entering (also available on the product package labelling).

Voice and data connectors and adapters

Support plates for two computer connectors according to table.
Whitout claws

Packing 1



	Reference	Colour	Compatible connectors
	5TG2078	Red	<ul style="list-style-type: none"> - AMP-Type 216000-2 y 216005-4 - Krone MT-RJ 7023.1.303-xx, Cat. 6 STP 6830.1.312-xx, Cat. 6 UTP 6830.1.302-xx, Cat. 6 UTP 6380.1.800-xx, Cat. 6 UTP 6380.1.810-xx - Molex KSJ-00033-02/-04 - Radiall R 280 MOD 802/803/804/805/807 - Siemon MX-K-C5-80-ND/-02 ND - Telegärtner Cat.6 J00029A0036
	5TG2080	Black	<ul style="list-style-type: none"> - Leviton 41108, Cat. 5 - Panduit Keystone: KJ 688 Txx, Cat. 6, KJ 5e88 Txx, Cat. 5e - Brand Rex GPC Jack F01 3LF
	5TG2081	Yellow	<ul style="list-style-type: none"> - AMP-Tyco: 406372-x Cat. 5; 1116515-1 Cat. 5e; 1339015-1 Cat. 5e; 1375055-x Cat. 6; 1375187-x Cat. 6; 137188-1 Cat. 6; 1375189-1 Cat. 5e; 137190-x Cat. 5e; 137191-x Cat. 5e; 1375192-x Cat. 3 RJ11; 1375193-x Cat. 3 RJ11; 1116604-x Cat. 5e; 188650-3... 6; 338038-1 .. 4; 1711342-1; MTRJ127841-1; MTRJ127842-1 - ASYCO Cat. 5e/6 SFTP - Kerpen E-Line 600 GG45 Cat. 6 Keystone clip Nr. 9ZE20009 - Nexans LENmark-MJ with keystone clip N429.620
	5TG2082	Orange	<ul style="list-style-type: none"> - Setec: SeSix 501244; UKJ 501292 - Rutenbeck 13900 300 - MMC: MK 6 NB; MK 6 AN; MK 6 FS - DANCHIEF 568 A/B, Cat. 5 - Radiall R280 MOD 809 y MOD 811 - Hubbel HXJ 5 EBU y UTP - BTR UTP 130 A 10 I
	5TG2083	Blue	<ul style="list-style-type: none"> - Krone Cat. 5 STP 6540.1.1 54.xx, Cat. 5; UTP 6540.1.130.xx; UTP 6540.1.100.xx
	5TG2084	Brown	<ul style="list-style-type: none"> - Siemon MX6-FS
	5TG2058	Green	<ul style="list-style-type: none"> - AVAYA Anixter Systemax (Lucent Techn.): M11...en M100 (uitloop), MPS100E Cat. 5, MPS200E + MGS 400 Cat. 6 - Gigaspeed: X10D MGS500, X10D MFP520 - R&M - R30511, -2, -3 y -4 with adapter 310694
	5TG2058-1	Transparent	To accommodate up to 2 Modular Lexcom Jack connectors.
	5TG2058-2	White	To accommodate up to 2 Modular Jack Plug-in Conn. Nordix/CDT 061110 ao 405302 + 3.
	5TG2058-3	Grey	To accommodate up to 2 Modular Lexcom Jack connectors.
	5TG2058-4	Silver	To accommodate up to 2 3M Volition modular jack connectors.
	5TG2098	Beige	<ul style="list-style-type: none"> - BTR: E-DAT module N°. 130910-I - Daetwyler: Unilan MS 1/8 Cat. 6 (equivalent to BTR jack)

Voice and data connectors and adapters



Adapter with RJ45 tilted connector Cat 6, shielded

Simple **5TG2026-1**
Double **5TG2026-2**

- Adjustable rear output cable (+/- 30°)
- LSA cable terminals 0.4 -0.63 mm Ø, AWG 26 -22
- Cat.6 / Class E according to DIN EN 60
- Connector tilted at 45°

Packing 1



Adapter with RJ45 tilted connector Cat 6, unshielded

Simple **5TG2027-1**
Double **5TG2027-2**

- LSA cable terminals 0.4 -0.63 mm Ø, AWG 26 -22
- Cat.6 / Class A according to ISO/IEC 11801:2011-06, DIN EN 50 173-1:2011-09, TIA/EIA-568-B.2-10 2008.
- Connector tilted at 45°

TITLED RJ CONNECTOR COVER, SINGLE/DOUBLE RUTENBECK



POLAR WHITE 5TG1394-0WH	PLATINUM M. 5TG1394-1	ANTHRACITE C. 5TG1394-0AC	CHOCOLATE 5TG1394-0CH	MALT GOLD 5TG1394-0MG
Packing 1	1	2	2	2

TITLED RJ CONNECTOR COVER, SINGLE/DOUBLE RUTENBECK WITH LABELLING FIELD



POLAR WHITE 5TG1395-0WH	PLATINUM M. 5TG1395-1	ANTHRACITE C. 5TG1395-0AC	CHOCOLATE 5TG1395-0CH	MALT GOLD 5TG1395-0MG
Packing 1	1	2	2	2

Multimedia connectors



Type-A HDMI connector

Screwed terminals

- White
- Beige
- Grey

18578-HDMI
18578-HDMI-A
18578-HDMI-G

Packing 1



VGA connector

Maximum cable length 30 m.
 (depending on the type of cables)

Screwed terminals

- White
- Beige
- Grey

18578-VGA
18578-VGA-A
18578-VGA-G

Packing 1

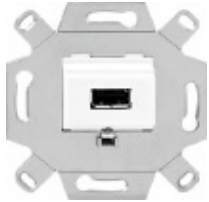

Type-A USB connector

Compatible with USB 2.0

Screwed terminals

- White
- Beige
- Grey

18578-USB
18578-USB-A
18578-USB-G

Packing 1



Double USB charger

5TG2025-3

- Input rated voltage: 100-250V AC
- Nominal frequency: 50-60Hz
- 2 x USB type A female
- Output rated voltage: 5 V DC
- Max. total current: 2,1A
- Consumption on standby: < 100mW
- complies with the ErP European Directive
- Short circuit protection
- Temperature protection

Standards and certificates: EN 62386-1

Packing 1

Check availability

COVER FOR MULTIMEDIA CONNECTORS



POLAR WHITE	PLATINUM M.	ANTHRACITE C.	CHOCOLATE	MALT GOLD
5TG1342-0WH	5TG1342-1	5TG1342-0AC	5TG1342-0CH	5TG1342-0MG
61778-WH	61778-PM	61778-AC	61778-CH	61778-DM
1	1	1	1	1

Equivalent ref.
Packing

COVER FOR DOUBLE USB CHARGER



POLAR WHITE	PLATINUM M.	ANTHRACITE C.	CHOCOLATE	MALT GOLD
5TG1378-0WH	5TG1378-0PM	5TG1378-0AC	5TG1378-0CH	5TG1378-0MG
61780-WH	61780-PM	61780-AC	61780-CH	61780-DM
1	1	1	1	1

Equivalent ref.
Packing

Sound



Loudspeaker connectors

- Single
- Stereo

5TG2467-2
5TG2468-2

Packing 1

COVER FOR MULTIMEDIA CONNECTORS



POLAR WHITE	PLATINUM M.	ANTHRACITE C.	CHOCOLATE	MALT GOLD
5TG1342-0WH	5TG1342-1	5TG1342-0AC	5TG1342-0CH	5TG1342-0MG
61778-WH	61778-PM	61778-AC	61778-CH	61778-DM
1	1	1	1	1

Equivalent ref.
Packing

Sound potentiometer

3 W, 27 Ω, mono

SOUND POTENTIOMETER



POLAR WHITE	PLATINUM M.	ANTHRACITE C.	CHOCOLATE	MALT GOLD
5TG4812-0WH	5TG4812-1	5TG4812-0AC	5TG4812-0CH	5TG4812-0MG
61778-WH	61778-PM	61778-AC	61778-CH	61778-DM
1	1	1	1	1

Note: Equivalent ref. is a valid reference for order entering (also available on the product package labelling).

Room thermostats

Room thermostat *

Monitoring and control of temperature in closed rooms
 Type of sensor: Bi-metal Voltage: 230 V~; 24 V~, 50 Hz
 Switching capacity at 230 Vac: 10(4) A, at 24 Vac: 1(1) A Setpoint range: 5 to 30 °C (numerical scale * to 6)

ROOM THERMOSTAT



	POLAR WHITE 5TC9774-4WH00	PLATINUM M. 5TC9774-4PM00	ANTHRACITE C. 5TC9774-4AC00	CHOCOLATE 5TC9774-4CH00	MALT GOLD 5TC9774-4MG00
Packing	1	1	1	1	1

Heated floor, electronic thermostat

Electronic temperature control for heating systems, for example: electric heated floor systems, bathrooms, ceilings, marbles and heated walls.
 Voltage: 230 V ~, 50 Hz
 Sensor: external or internal & external (monitor). Floor sensor included in the package. Cutting capacity: 16(2) A
 Range: 10 to 50 °C (scale of 1 to 5)
 Indications (LEDs): heating up (Network), and eco mode activated (green).
 Extension of the sensor: up to 50 m only with 0.5 mm² cable, double insulated.
 Note: Ensure that the sensor cabling is contained in protective insulation. It is not possible to wire the sensor in parallel with AC power lines.

HEATED FLOOR, ELECTRONIC THERMOSTAT



	POLAR WHITE 5TC9774-5WH00	PLATINUM M. 5TC9774-5PM00	ANTHRACITE C. 5TC9774-5AC00	CHOCOLATE 5TC9774-5CH00	MALT GOLD 5TC9774-5MG00
Packing	1	1	1	1	1

* The Style range requires the 55 x 55mm insert adapter for installation.

55 x 55mm insert adapter

ADAPTER



	POLAR WHITE 5TG1327-0WH	PLATINUM M. 5TG1327-1	ANTHRACITE C. 5TG1327-0AC	CHOCOLATE 5TG1327-0CH	MALT GOLD 5TG1327-0MG
Packing	1	1	1	1	1

Motion detector



Spherical motion detector
3-wire mechanism **18555-3**
 Contact rating (3-wire, relay output):
 Resistive load 2,300 W, 10 A max., cos φ = 1
 Inductive load 1,500 W, 5 A max., cos φ = 0.6
 Halogen with 1000 V transformer
 Electronic ballasts e.g. 2 x 36 W (20 max.)
 Compatible with LED loads

COVER FOR SPHERICAL MOTION DETECTOR



	POLAR WHITE 5TG6278-6WH	PLATINUM M. 5TG6278-6PM	ANTHRACITE C. 5TG6278-6AC	CHOCOLATE 5TG6278-6CH	MALT GOLD 5TG6278-6MG
Packing	1 NEW	1 NEW	1 NEW	1 NEW	1 NEW

Packing 1

* The Style range requires the 55 x 55mm insert adapter for installation.

55 x 55mm insert adapter

ADAPTER



	POLAR WHITE 5TG1327-0WH	PLATINUM M. 5TG1327-1	ANTHRACITE C. 5TG1327-0AC	CHOCOLATE 5TG1327-0CH	MALT GOLD 5TG1327-0MG
Packing	1	1	1	1	1

Buzzers and indicators lights



Buzzer module

- Polar white
- Aluminium metallic
- Carbon metallic

5TG9875-8WH
5TG9875-8AM
5TG9875-8CM

230V
 Packing 1



LED indicator light

- 90...240 V AC, 50/60 Hz
 1 W, vertical or horizontal position
- White
 - Blue
 - Red
 - Green

5TG9880-3
5TG9880-4
5TG9880-5
5TG9880-6

Packing 1

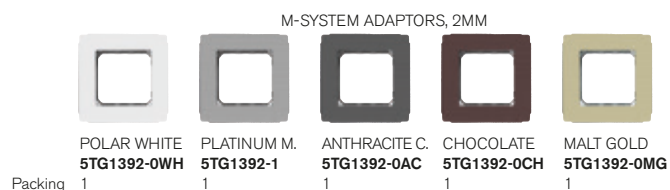
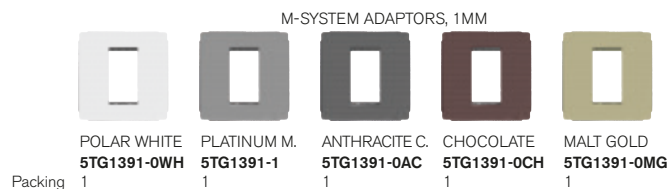

Other inserts



Push-button, normally-open contact **5TD2120**

Packing 1

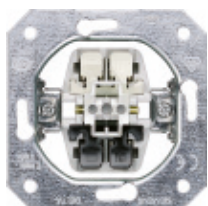

Push-button, changeover contact **5TD2123**

Common to the entire DELTA-series

Packing 1

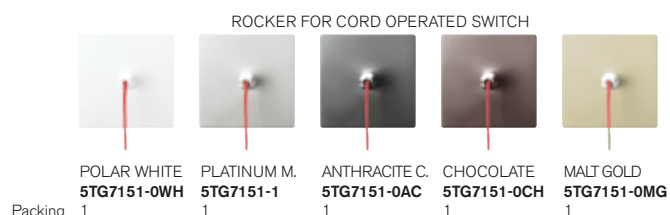

Style blank cover



Style cable output

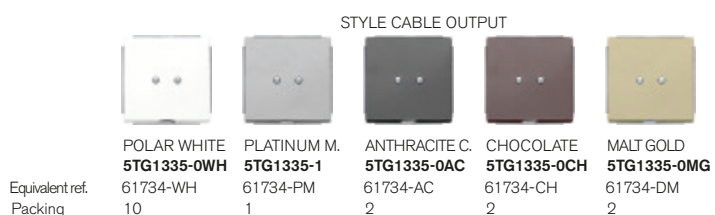

Style intermediate frames

For 51x51 mm inserts



POLAR
WHITE
Packing
1
5TG1326-0WH



PLATINUM
METALLIC
Packing
1
5TG1326-1



ANTHRACITE
COSSO
Packing
1
5TG1326-0AC



CHOCOLATE
Packing
1
5TG1326-0CH



MALT GOLD
Packing
1
5TG1326-0MG

For 55x55 mm inserts - To adapt mechanisms of other manufacturers



POLAR
WHITE
Packing
1
5TG1327-0WH



PLATINUM
METALLIC
Packing
1
5TG1327-1



ANTHRACITE
COSSO
Packing
1
5TG1327-0AC



CHOCOLATE
Packing
1
5TG1327-0CH



MALT GOLD
Packing
1
5TG1327-0MG

For 61x61 mm inserts - To adapt mechanisms of other manufacturers



POLAR
WHITE
Packing
1
5TG1328-0WH



PLATINUM
METALLIC
Packing
1
5TG1328-1



ANTHRACITE
COSSO
Packing
1
5TG1328-0AC



CHOCOLATE
Packing
1
5TG1328-0CH



MALT GOLD
Packing
1
5TG1328-0MG

Style surface mounting box IP20



Surface mounting box

• Polar white

- Single, 84 mm x 84 mm x 42,5 mm **5TG2901-0WH**
- Double 155 mm x 84 mm x 42,5 mm **5TG2902-0WH**
- Triple 226 mm x 84 mm x 42,5 mm **5TG2903-0WH**

Packing 1

• Platinum

- Single, 84 mm x 84 mm x 42,5 mm **5TG2901-1**
- Double 155 mm x 84 mm x 42,5 mm **5TG2902-1**
- Triple 226 mm x 84 mm x 42,5 mm **5TG2903-1**

Packing 1

Plastic inputs for Style surface mounting box IP20

Cable entry slide nipple For surface mounting box (1 set contains 10 units)

- Polar white **5TG2905-0WH**

























1 set supplied

Cable entry slide nipple (1 set contains 10 units)

- White polar **5TG2904-0WH**

1 set supplied





Style frames

POLAR WHITE		PLATINUM METALLIC		ANTHRACITE COSSO		CHOCOLATE		MALT GOLD	
Packing		Packing		Packing		Packing		Packing	
	5TG1321-0WH 10 61001-WH		5TG1321-1 1 61001-PM		5TG1321-0AC 1 61001-AC		5TG1321-0CH 1 61001-CH		5TG1321-0MG 1 61001-DM
	5TG1322-0WH 10 61002-WH		5TG1322-1 1 61002-PM		5TG1322-0AC 1 61002-AC		5TG1322-0CH 1 61002-CH		5TG1322-0MG 1 61002-DM
	5TG1323-0WH 10 61003-WH		5TG1323-1 1 61003-PM		5TG1323-0AC 1 61003-AC		5TG1323-0CH 1 61003-CH		5TG1323-0MG 1 61003-DM
	5TG1324-0WH 1 61004-WH		5TG1324-1 1 61004-PM		5TG1324-0AC 1 61004-AC		5TG1324-0CH 1 61004-CH		5TG1324-0MG 1 61004-DM
	5TG1325-0WH 1 61005-WH		5TG1325-1 1 61005-PM		5TG1325-0AC 1 61005-AC		5TG1325-0CH 1 61005-CH		5TG1325-0MG 1 61005-DM

Note: Equivalent ref. is a valid reference for order entering (also available on the product package labelling)

For a correct installation of Style frames on plasterboard walls, it is necessary to use the hole saw hardened teeth shank 2158000 (or equivalent) for a right flush installation in the wall.

MEASUREMENTS

	82 x 82 mm
	82 x 153 mm
	82 x 224 mm
	82 x 295 mm
	82 x 366 mm

Flush-mounting boxes



Flush-mounting box 2373-I
Thermoplastic material
Dimensions: 71x71x43 mm
Packing 640



Protective cover 2374-I
Allows you to locate the box after plastering
Packing 1000



Claws 16-GAR
for metal frames
Bag with 50 claws and 50 screws
To mount 25 frames



Flush-mounting box 2341
1 element for plasterboard wall
Packing 120



Flush-mounting box 2342
2 elements for plasterboard wall
Packing 60



Flush-mounting box 2343
3 elements for plasterboard wall
Packing 35



Flush-mounting box 2344
4 elements for plasterboard wall
Packing 30



Flush-mounting box 2345
5 elements for plasterboard wall
Packing 21



Hole saw hardened 2158000
teeth shank for plasterboard wall
diam. 68mm
depth 40mm
Packing 1



Deburrer for Plasterboard 5892000
NEW
Ø 68 mm
Tool for flush installation of hollow wall boxes
Packing 1



Replacement blades 5893000
NEW
for ref. 5892000
Packing 1

To achieve the designed installation results, the use of these boxes and the hole saw hardened teeth shank is recommended.

SIEMENS

Miro

Unique atmospheres

Miro series combines style and the influence of late Bauhaus. Miro demonstrates an innovative and different concept with its lines, something that can only be achieved when things are done properly. This top-quality series has the perfect finish in all details, with exclusive and modern textures. The square shape, smooth surface, fine chrome-plated line on the angle of the customised switches and materials make up a harmonious unit that makes it different, meeting and exceeding the high expectations of customers with its quality, design and feel.



Real aluminium



Crystal



Painted finish



Wood



Matt finish





A contemporary classic

Miro

- Floating frame, seems to be suspended in mid air, visual lightness.
- The frame is only 8 mm high.
- Square and compact switch diffuser, blue LED lighting.
- Solid and natural glass, wood and metal frames.
- Switch with or without embellisher, to be chosen by the interior designer.

Matt colours



Matt white



Matt black

- Miro matt, stylish contrast.
- Miro glass, impeccable elegance.
- Miro wood, natural appeal.
- Miro aluminium, calm and accurate.
- Miro colour, practical and light.

Glass



Orient Red /
Carbon Metallic

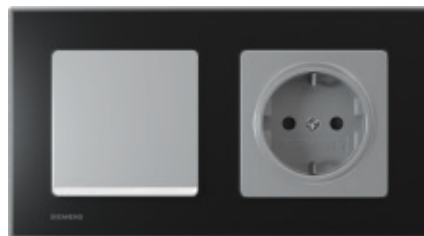

Black /
Aluminium Metallic

Wood

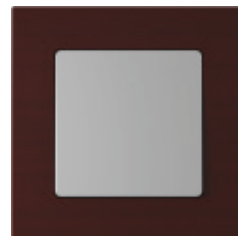

Maple Red /
Aluminium Metallic



Cherry /
Carbon Metallic

Aluminium



Natural /
Carbon Metallic



Yellow rust /
Polar White

Colour



Polar White



Aluminium Metallic



Carbon Metallic

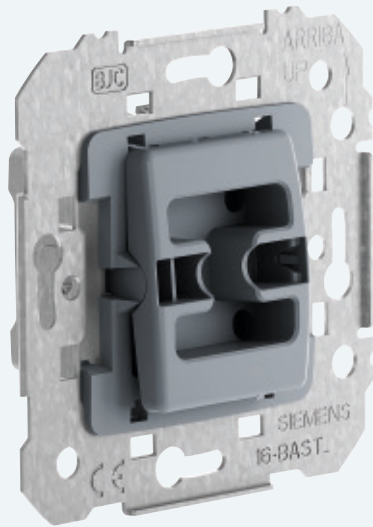

Its structure has an ergonomic design to guarantee easy, quick and comfortable installation. It features a compact mechanism to use all space inside the mounting box and facilitates cable routing. It is designed to ensure proper installation.

- One-way and two-way MEC18 switches rated at 16A are used, allowing many different applications with the same mechanism and reducing the number of items and references that must be stocked.
- Galvanised steel fixing frames with anti-corrosion treatment to ensure durable installation components.
- Fixing frames with upper and lower profiles to facilitate assembly and a rigid position of the mechanism.

The socket outlets feature increased touch protection elements and use standard STAI connectors (open safety screw system), which only require connection and tightening. The screws close with a single operation and have an engraved floating nut which prevents the cable from slipping and guarantees perfect fixture across the whole of the contact surface. The three conductors enter through the top of the socket outlet. They are also screwed on one side of the socket outlet. The outlets, which are supplied separately from the covers, allow terminal connection and fast and safe fixture.

Certifications

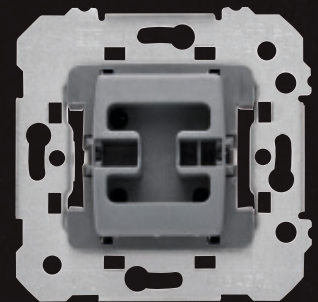

MEC 18

The same mechanism for 5 different designs

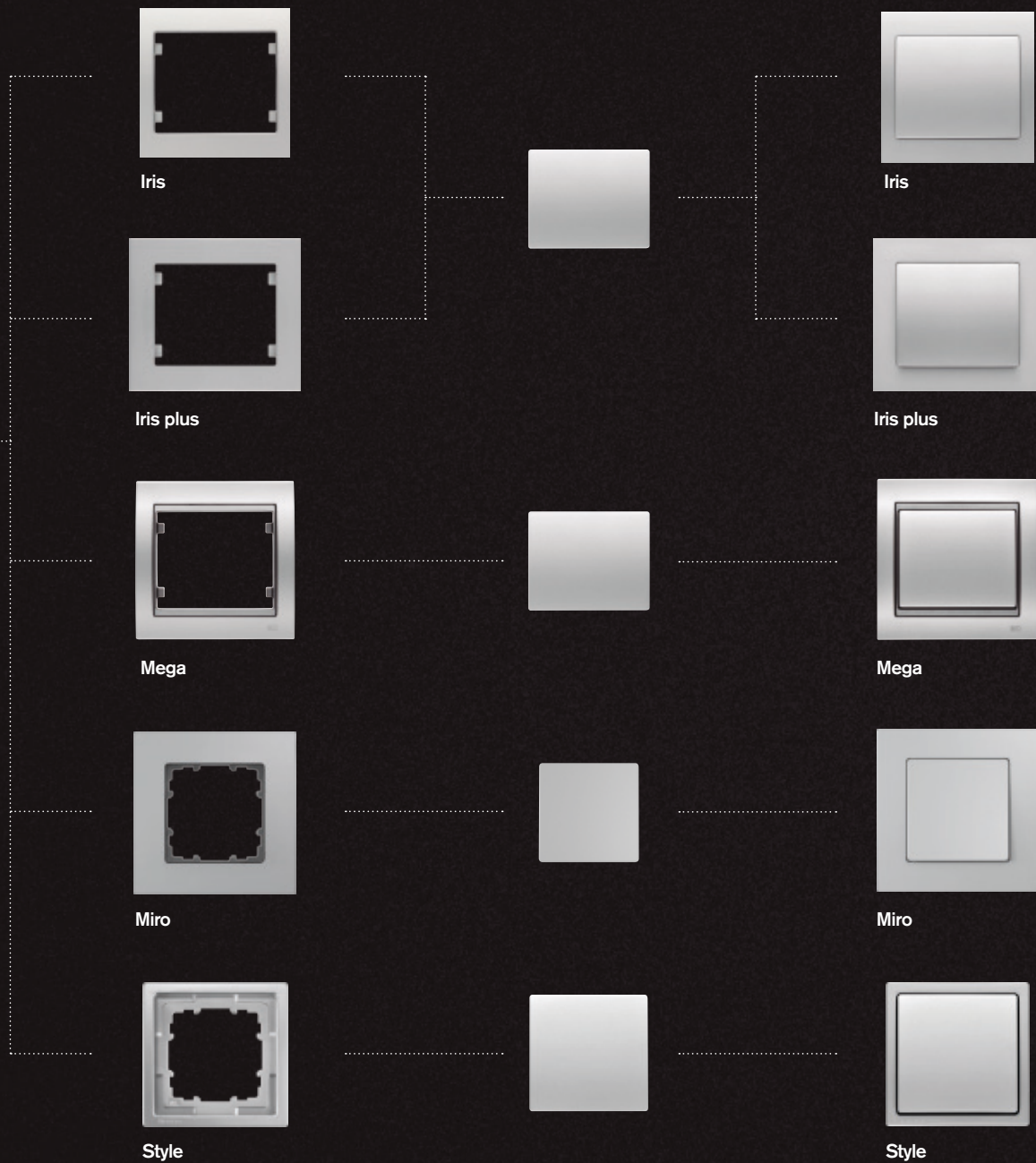

Many different functions

The Miro series offers a wide range of functions to cater to today's needs. Light intensity dimmers, sound controllers and blind rolling up and down mechanisms. Choose the options you need, guaranteeing total comfort and enjoy our solutions' colourful and appealing designs.



Dimmers

Dimmers are the perfect element create an atmosphere in rooms by adjusting the lighting levels to the desired intensity. The intensity can be increased or decreased. The power and technology of the different lamps requires using specific dimmers, adapted in each case to adjust the power levels. BJC offers a wide range of dimmers, suitable for different lamps and power ratings.



Chargers with double USB

The Schuko® socket with double USB Type A and Type C allows the simultaneous charging of two terminals while maintaining the usability of the socket. Quick and easy installation in a standard flush-mounted box.

- Power Delivery (required by EU by the end of 2024)
- Quick charge
- For standard flush-mounted box.



Multimedia

The multimedia connectors are the perfect solution to prevent exposed wiring in the installation and for the distribution of electronic devices in any type of installation; whether household or commercial. The HDMI, VGA, RJ45, stereo cable and other outputs can provide separate input and output sources, for efficient connections and uncluttered installations.



LED indicator

Siemens' modular LED indicators are used to indicate: stairs, waiting rooms, interiors, corridors and calls. They are available in three tones of white, green and red. The modular system allows the combination of two beacon lights or two elements, such as a buzzer and LED beacon light, indicating that there is a call; sound and visual.



Smart solutions with KNX

KNX connects a network of functions, including security, climate-control, lighting and multimedia devices. The system's centralised and smart control systems can cater to the needs of each specific case and can be programmed at any time. With a discreet design, Siemens' keyboards allow the installation to be easily and comfortably handled.

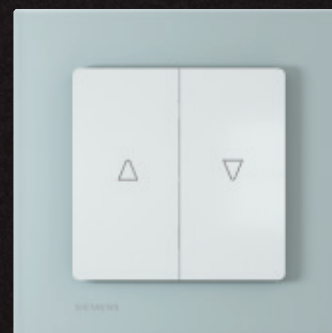

Centralised blind control

By simply pressing a button, this allows you to pull all the blinds in a house or on a floor down, either individually or centrally.

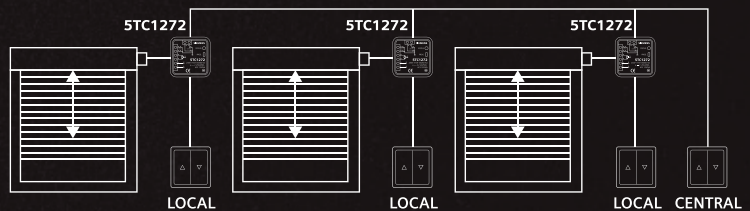

16 A in Mec switches

The switches feature a powerful 16 A device with automatic terminal connection, with an ergonomic design for comfortable, easy and safe handling.

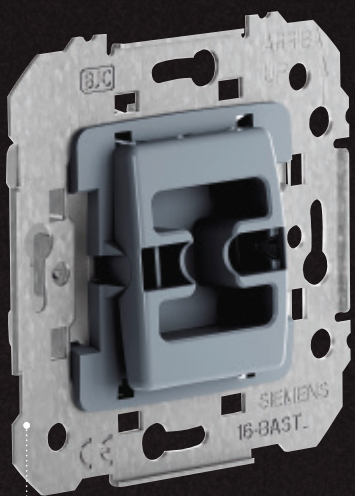

Mechanism

Mec 18 mechanism, which can be adapted to Iris, Iris plus, Mega and Siemens products for your comfort.

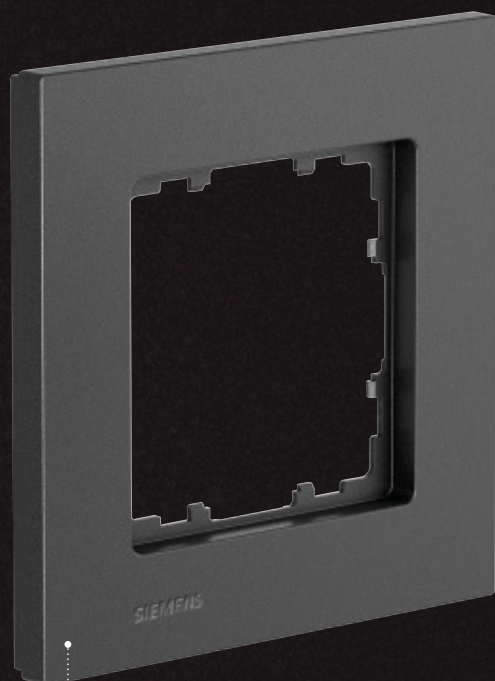

Frame

Select and long-lasting materials. Exclusive and high-quality finishes.



Switch

Accurate operation. Smooth and comfortable to the touch.

Table for composing basic functions - Miro

	● Polar white		● Aluminium metallic		● Carbon metallic		● Matt white		● Matt black	
Function	Mechanism	Switch/ Cover	Mechanism	Switch/ Cover	Mechanism	Switch/ Cover	Mechanism	Switch/ Cover	Mechanism	Switch/ Cover
One-way switch	18505	5TG62705WH00	18505	5TG62705AM00	18505	5TG62705CM00	18505	5TG62705SW00	18505	5TG62705SB00
Two-way switch	18506	5TG62705WH00	18506	5TG62705AM00	18506	5TG62705CM00	18506	5TG62705SW00	18506	5TG62705SB00
Intermediate switch	18507	5TG62705WH00	18507	5TG62705AM00	18507	5TG62705CM00	18507	5TG62705SW00	18507	5TG62705SB00
Double one-way switch	18509	5TG62701WH00	18509	5TG62701AM00	18509	5TG62701CM00	18509	5TG62701SW00	18509	5TG62701SB00
Double two-way switch	18510	5TG62701WH00	18510	5TG62701AM00	18510	5TG62701CM00	18510	5TG62701SW00	18510	5TG62701SB00
Bell push-button	18516	5TG62705WH10	18516	5TG62705AM10	18516	5TG62705CM10	18516	5TG62705SW10	18516	5TG62705SB10
Bulb push-button	18516	5TG62705WH20	18516	5TG62705AM20	18516	5TG62705CM20	18516	5TG62705SW20	18516	5TG62705SB20
Dimmer	21549-X	5TC89000WH	21549-X	5TC89000AM	21549-X	5TC89000CM	21549-X	5TC89000SW	21549-X	5TC89000SB
Schuko® socket	18524	5UH10724WH	18524	5UH10724AM	18524	5UH10724CM	18524	5UH10724SW	18524	5UH10724SB
Schuko® + double USB Type A and Type C socket	18524-USBC	5UH10725WH10	18524-USBC	5UH10725AM10	18524-USBC	5UH10725CM10	18524-USBC	5UH10725SW10	18524-USBC	5UH10725SB10
TV/FM socket outlet	5TG25610WH		5TG1253		5TG1223		5TG25610SW		5TG25610SB	
Adapter for 1 RJ connector	19582-1	5TG20782WH01	19582-1	5TG20782AM01	19582-1	5TG20782CM01	19582-1	5TG20782SW01	19582-1	5TG20782SB01
Adapter for 2 RJ connectors	19682-1	5TG20782WH02	19682-1	5TG20782AM02	19682-1	5TG20782CM02	19682-1	5TG20782SW02	19682-1	5TG20782SB02
Blank cover	5TG25580WH		5TG1250		5TG1220		5TG25580SW		5TG25580SB	
Cable output	5TG25660WH		5TG1251		5TG1221		5TG25660SW		5TG25660SB	
Buzzer	5TG98758WH	5TG20080WH	5TG98758AM	5TG2094	5TG98758CM	5TG2096	5TG98758WH	5TG20080SW	5TG98758CM	5TG20080SB
Key card switch	5TG48200WH		5TG4821		5TG4822		5TG48200SW		5TG48200SB	
Frame	5TG11110WH		5TG11111		5TG11112		5TG11110SW		5TG11110SB	

Switches

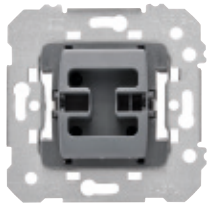

One-way switch **18505***
Two-way switch **18506***
 16 A 250 V~
Intermediate switch **18507***
 10 A 250 V~

Packing 10

ROCKER				
POLAR WHITE 5TG6270-5WH00	ALUMINIUM M. 5TG6270-5AM00	CARBON M. 5TG6270-5CM00	MATT WHITE 5TG6270-5SW00	MATT BLACK 5TG6270-5SB00
Equivalent ref. 59705-WH	59705-AM	59705-CM	59705-SW	59705-SB
Packing 10	10	10	1	1

ROCKER				
with bright chrome embellisher			with matt nickel embellisher	
POLAR WHITE 5TG6270-5CW00	ALUMINIUM M. 5TG6270-5CA00	CARBON M. 5TG6270-5CC00	MATT WHITE 5TG6270-5CS00	MATT BLACK 5TG6270-5CB00
Equivalent ref. 59705-CW	59705-CA	59705-CC	59705-CS	59705-CB
Packing 10	10	10	1	1

ROCKER WITH LENS				
POLAR WHITE 5TG6270-5WH01	ALUMINIUM M. 5TG6270-5AM01	CARBON M. 5TG6270-5CM01	MATT WHITE 5TG6270-5SW01	MATT BLACK 5TG6270-5SB01
Equivalent ref. 59705-WHL	59705-AML	59705-CML	59705-SWL	59705-SBL
Packing 10	2	2	1	1

ROCKER WITH LENS				
with bright chrome embellisher			with matt nickel embellisher	
POLAR WHITE 5TG6270-5CW01	ALUMINIUM M. 5TG6270-5CA01	CARBON M. 5TG6270-5CC01	MATT WHITE 5TG6270-5CS01	MATT BLACK 5TG6270-5CB01
Equivalent ref. 59705-CWL	59705-CAL	59705-CCL	59705-CSL	59705-CBL
Packing 10	2	2	1	1

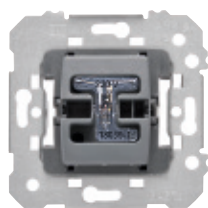

One-way switch with control light **18605***
Two-way switch with control light **18606***
Two-way switch with indicator light **18506-L***
 16 A 250 V~

Packing 10

Neon lamp incorporated in reference 18506-L

ROCKER WITH LENS				
POLAR WHITE 5TG6270-5WH01	ALUMINIUM M. 5TG6270-5AM01	CARBON M. 5TG6270-5CM01	MATT WHITE 5TG6270-5SW01	MATT BLACK 5TG6270-5SB01
Equivalent ref. 59705-WHL	59705-AML	59705-CML	59705-SWL	59705-SBL
Packing 10	2	2	1	1

ROCKER WITH LENS				
with bright chrome embellisher			with matt nickel embellisher	
POLAR WHITE 5TG6270-5CW01	ALUMINIUM M. 5TG6270-5CA01	CARBON M. 5TG6270-5CC01	MATT WHITE 5TG6270-5CS01	MATT BLACK 5TG6270-5CB01
Equivalent ref. 59705-CWL	59705-CAL	59705-CCL	59705-CSL	59705-CBL
Packing 10	2	2	1	1

Note: Equivalent ref. is a valid reference for order entering (also available on the product package labelling).

* The Siemens Miro and Style series are compatible with inserts manufactured from January 2017 onwards.

Switches

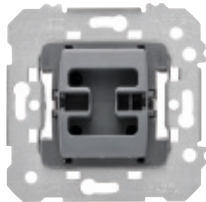

2 pole one-way switch **18508***
Only rockers with **18608***
indicator light
 16 A 250 V~
 Only rockers with indicator light

Packing 10

Neon lamp incorporated in reference 18608

		ROCKER WITH I / O				
		POLAR WHITE 5TG6270-5WH40	ALUMINIUM M. 5TG6270-5AM40	CARBON M. 5TG6270-5CM40	MATT WHITE 5TG6270-5SW40	MATT BLACK 5TG6270-5SB40
Equivalent ref.		59708-WH	59708-AM	59708-CM	59708-SW	59708-SB
Packing		2	2	2	1	1
		ROCKER WITH I / O AND LENS				
		with bright chrome embellisher			with matt nickel embellisher	
		POLAR WHITE 5TG6270-5CW40	ALUMINIUM M. 5TG6270-5CA40	CARBON M. 5TG6270-5CC40	MATT WHITE 5TG6270-5CS40	MATT BLACK 5TG6270-5CB40
Equivalent ref.		59708-CW	59708-CA	59708-CC	59708-CS	59708-CB
Packing		2	2	2	1	1
		ROCKER WITH I / O AND LENS				
		with bright chrome embellisher			with matt nickel embellisher	
		POLAR WHITE 5TG6270-5WH41	ALUMINIUM M. 5TG6270-5AM41	CARBON M. 5TG6270-5CM41	MATT WHITE 5TG6270-5SW41	MATT BLACK 5TG6270-5SB41
Equivalent ref.		59708-WHL	59708-AML	59708-CML	59708-SWL	59708-SBL
Packing		2	2	2	1	1
		ROCKER WITH I / O AND LENS				
		with bright chrome embellisher			with matt nickel embellisher	
		POLAR WHITE 5TG6270-5CW41	ALUMINIUM M. 5TG6270-5CA41	CARBON M. 5TG6270-5CC41	MATT WHITE 5TG6270-5CS41	MATT BLACK 5TG6270-5CB41
Equivalent ref.		59708-CWL	59708-CAL	59708-CCL	59708-CSL	59708-CBL
Packing		2	2	2	1	1

Note: Equivalent ref. is a valid reference for order entering (also available on the product package labelling).

* The Siemens Miro and Style series are compatible with inserts manufactured from January 2017 onwards.

Switches

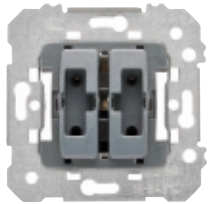

Double one-way switch **18509***
Double two-way switch **18510***
 16 A 250 V~
Double push-button **18511***
 10 A 250 V~
Double push-button, normally-closed **18513***
 10 A 250 V~

Packing 10

DOUBLE ROCKER



	POLAR WHITE 5TG6270-1WH00	ALUMINIUM M. 5TG6270-1AM00	CARBON M. 5TG6270-1CM00	MATT WHITE 5TG6270-1SW00	MATT BLACK 5TG6270-1SB00
Equivalent ref.	59709-WH	59709-AM	59709-CM	59709-SW	59709-SB
Packing	10	10	10	1	1

DOUBLE ROCKER

with bright chrome embellisher

with matt nickel embellisher



	POLAR WHITE 5TG6270-1CW00	ALUMINIUM M. 5TG6270-1CA00	CARBON M. 5TG6270-1CC00	MATT WHITE 5TG6270-1CS00	MATT BLACK 5TG6270-1CB00
Equivalent ref.	59709-CW	59709-CA	59709-CC	59709-CS	59709-CB
Packing	10	10	10	1	1

DOUBLE ROCKER WITH LENS



	POLAR WHITE 5TG6270-1WH01	ALUMINIUM M. 5TG6270-1AM01	CARBON M. 5TG6270-1CM01	MATT WHITE 5TG6270-1SW01	MATT BLACK 5TG6270-1SB01
Equivalent ref.	59709-WHL	59709-AML	59709-CML	59709-SWL	59709-SBL
Packing	10	2	2	1	1

DOUBLE ROCKER WITH LENS

with bright chrome embellisher

with matt nickel embellisher



	POLAR WHITE 5TG6270-1CW01	ALUMINIUM M. 5TG6270-1CA01	CARBON M. 5TG6270-1CC01	MATT WHITE 5TG6270-1CS01	MATT BLACK 5TG6270-1CB01
Equivalent ref.	59709-CWL	59709-CAL	59709-CCL	59709-CSL	59709-CBL
Packing	10	2	2	1	1

Double push-button with lamp **18511-L***
 10 A 250 V~

Packing 10

Neon lamp incorporated in reference 18511-L

DOUBLE ROCKER WITH LENS



	POLAR WHITE 5TG6270-1WH01	ALUMINIUM M. 5TG6270-1AM01	CARBON M. 5TG6270-1CM01	MATT WHITE 5TG6270-1SW01	MATT BLACK 5TG6270-1SB01
Equivalent ref.	59709-WHL	59709-AML	59709-CML	59709-SWL	59709-SBL
Packing	10	2	2	1	1

DOUBLE ROCKER WITH LENS

with bright chrome embellisher

with matt nickel embellisher



	POLAR WHITE 5TG6270-1CW01	ALUMINIUM M. 5TG6270-1CA01	CARBON M. 5TG6270-1CC01	MATT WHITE 5TG6270-1CS01	MATT BLACK 5TG6270-1CB01
Equivalent ref.	59709-CWL	59709-CAL	59709-CCL	59709-CSL	59709-CBL
Packing	10	2	2	1	1

Note: Equivalent ref. is a valid reference for order entering (also available on the product package labelling).

* The Siemens Miro and Style series are compatible with inserts manufactured from January 2017 onwards.



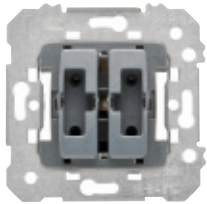







Switches



**Two-way switch
+ Push-button**
16 A + 10 A 250 V~

Packing 10

18515*

		DOUBLE ROCKER DOBL, BELL SYMBOL				
						
		POLAR WHITE 5TG6270-1WH10	ALUMINIUM M. 5TG6270-1AM10	CARBON M. 5TG6270-1CM10	MATT WHITE 5TG6270-1SW10	MATT BLACK 5TG6270-1SB10
Equivalent ref.		59715-WH	59715-AM	59715-CM	59715-SW	59715-SB
Packing		2	2	2	1	1
		DOUBLE ROCKER DOBLE WITH CHROME EMBELLISHER, BELL SYMBOL				
		with bright chrome embellisher		with matt nickel embellisher		
						
		POLAR WHITE 5TG6270-1CW10	ALUMINIUM M. 5TG6270-1CA10	CARBON M. 5TG6270-1CC10	MATT WHITE 5TG6270-1CS10	MATT BLACK 5TG6270-1CB10
Equivalent ref.		59715-CW	59715-CA	59715-CC	59715-CS	59715-CB
Packing		2	2	2	1	1

Note: Equivalent ref. is a valid reference for order entering (also available on the product package labelling).

* The Siemens Miro and Style series are compatible with inserts manufactured from January 2017 onwards.

Push-buttons

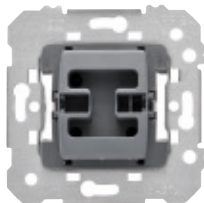

Push-button normally-open 18516*
Push-button normally-closed 18512*
 10 A 250 V~

Packing 10

Note:
 Pictograms can be added
 on request



ROCKER BELL / BULB SYMBOL



POLAR WHITE ALUMINIUM M. CARBON M. MATT WHITE MATT BLACK

5TG6270-5WH10 **5TG6270-5AM10** **5TG6270-5CM10** **5TG6270-5SW10** **5TG6270-5SB10**

Equivalent ref. 59716-WH 59716-AM 59716-CM 59716-SW 59716-SB
 Packing 10 10 10 1 1

5TG6270-5WH20 **5TG6270-5AM20** **5TG6270-5CM20** **5TG6270-5SW20** **5TG6270-5SB20**

Equivalent ref. 59717-WH 59717-AM 59717-CM 59717-SW 59717-SB
 Packing 10 10 10 1 1

ROCKER BELL / BULB SYMBOL

with bright chrome embellisher

with matt nickel embellisher



POLAR WHITE ALUMINIUM M. CARBON M. MATT WHITE MATT BLACK

5TG6270-5CW10 **5TG6270-5CA10** **5TG6270-5CC10** **5TG6270-5CS10** **5TG6270-5CB10**

Equivalent ref. 59716-CW 59716-CA 59716-CC 59716-CS 59716-CB
 Packing 10 10 10 1 1

5TG6270-5CW20 **5TG6270-5CA20** **5TG6270-5CC20** **5TG6270-5CS20** **5TG6270-5CB20**

Equivalent ref. 59717-CW 59717-CA 59717-CC 59717-CS 59717-CB
 Packing 10 10 10 1 1

ROCKER WITH LENS BELL / BULB SYMBOL



POLAR WHITE ALUMINIUM M. CARBON M. MATT WHITE MATT BLACK

5TG6270-5WH11 **5TG6270-5AM11** **5TG6270-5CM11** **5TG6270-5SW11** **5TG6270-5SB11**

Equivalent ref. 59716-WHL 59716-AML 59716-CML 59716-SWL 59716-SBL
 Packing 10 2 2 1 1

5TG6270-5WH21 **5TG6270-5AM21** **5TG6270-5CM21** **5TG6270-5SW21** **5TG6270-5SB21**

Equivalent ref. 59717-WHL 59717-AML 59717-CML 59717-SWL 59717-SBL
 Packing 10 10 10 1 1

ROCKER WITH LENS BELL / BULB SYMBOL

with bright chrome embellisher

with matt nickel embellisher



POLAR WHITE ALUMINIUM M. CARBON M. MATT WHITE MATT BLACK

5TG6270-5CW11 **5TG6270-5CA11** **5TG6270-5CC11** **5TG6270-5CS11** **5TG6270-5CB11**

Equivalent ref. 59716-CWL 59716-CAL 59716-CCL 59716-CSL 59716-CBL
 Packing 10 2 2 1 1

5TG6270-5CW21 **5TG6270-5CA21** **5TG6270-5CC21** **5TG6270-5CS21** **5TG6270-5CB21**

Equivalent ref. 59717-CWL 59717-CAL 59717-CCL 59717-CSL 59717-CBL
 Packing 10 10 10 1 1

Note: Equivalent ref. is a valid reference for order entering (also available on the product package labelling).

* The Siemens Miro and Style series are compatible with inserts manufactured from January 2017 onwards.

Push-buttons

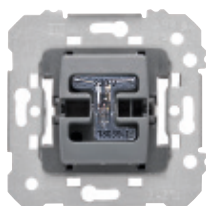

Push-button with timed switch and indicator light 18599*

Push-button with timed switch and indicator light

Power supply voltage: 230V~ 50Hz

Consumption: 5VA

Loads:

- Incandescent and halogen 230V: 40 - 400W
 - Halogen lamps with ferromagnetic transformer: 50 - 320W
 - Halogen lamps with electronic transformer: 40 - 400W
 - Motors: 36-100W/10 min.
- Time adjustable from 30s to 10min
Packing 1

ROCKER WITH LENS, BULB SYMBOL



	POLAR WHITE 5TG6270-5WH21	ALUMINIUM M. 5TG6270-5AM21	CARBON M. 5TG6270-5CM21	MATT WHITE 5TG6270-5SW21	MATT BLACK 5TG6270-5SB21
Equivalent ref.	59717-WHL	59717-AML	59717-CML	59717-SWL	59717-SBL
Packing	10	10	10	1	1

ROCKER WITH LENS, BULB SYMBOL

with bright chrome embellisher

with matt nickel embellisher



	POLAR WHITE 5TG6270-5CW21	ALUMINIUM M. 5TG6270-5CA21	CARBON M. 5TG6270-5CC21	MATT WHITE 5TG6270-5CS21	MATT BLACK 5TG6270-5CB21
Equivalent ref.	59717-WHL	59717-AML	59717-CML	59717-CSL	59717-CBL
Packing	10	10	10	1	1

Note: Equivalent ref. is a valid reference for order entering (also available on the product package labelling).

* The Siemens Miro and Style series are compatible with inserts manufactured from January 2017 onwards.

Electronic timer switches



Adjustable electronic timer switch

2382

Power supply voltage: 230V~ 50Hz
Consumption: 5VA

Loads:

- Incandescent and halogen 230V: 40 - 400W
- Halogen lamps with ferromagnetic transformer: 50 - 320W
- Halogen lamps with electronic transformer: 40 - 400W
- Motors: 36-100W

Time adjustable from 30s to 10 min

Packing 1

Note:
Pictograms can be added
on request



Key card switches

Key card switch with lighted labelling field

Mechanical operation, 1 push-button, normally-open with separated neutral terminal.

For cards up to 54x65 mm and 0.7-1.0 mm thick.

Includes lamp for indicator light.



	POLAR WHITE	ALUMINIUM M.	CARBON M.	MATT WHITE	MATT BLACK
Equivalent ref.	5TG4820-0WH	5TG4821	5TG4822	5TG4820-0SW	5TG4820-0SB
Packing	59068-WH	59068-AM	59068-CM	59068-SW	59068-SB
	1	1	1	1	1

Indicator lights



Blue LED indicator light

18039-1AZ

230 V~

Indicator light for 2 pole one-way switches and single pole one-way switches with control light
Wide rocker

Packing 18039-1AZ = 5



Blue LED indicator light

18039-2AZ

230 V~

Indicator lights for one-way switches, two-way switches, intermediate switches and push-buttons.
Wide rocker

Packing 18039-2AZ = 10



Blue LED indicator light

18039-3AZ

230 V~

Indicator lights for all different kind of inserts
Narrow rocker

Packing 18039-3AZ = 10



Load for indicator lights with energy saving and fluorescent lamps

3139

Packing 1

Insert for blinds

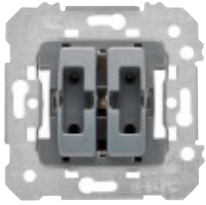

Double push-button for blinds 18565*

Double switch for blinds 18569*

With electrical and mechanical interlocking device
10 A 250 V~

Packing 10

Double push-button 18511*

Suitable for connecting any blind control device
No interlocking device
10 A 250 V~

Packing 10

DOUBLE ROCKER FOR BLINDS



POLAR WHITE ALUMINIUM M. CARBON M. MATT WHITE MATT BLACK

5TG6276-5WH00 5TG6276-5AM00 5TG6276-5CM00 5TG6276-5SW00 5TG6276-5SB00

Equivalent ref.	59765-WH	59765-AM	59765-CM	59765-SW	59765-SB
Packing	10	2	2	1	1

DOUBLE ROCKER FOR BLINDS



POLAR WHITE ALUMINIUM M. CARBON M. MATT WHITE MATT BLACK

5TG6276-5CW00 5TG6276-5CA00 5TG6276-5CC00 5TG6276-5CS00 5TG6276-5CB00

Equivalent ref.	59765-CW	59765-CA	59765-CC	59765-CS	59765-CB
Packing	10	2	2	1	1

Note: Equivalent ref. is a valid reference for order entering (also available on the product package labelling).

* The Siemens Miro and Style series are compatible with inserts manufactured from January 2017 onwards.

Blinds control



Blind control to be installed in a flush-mounting box

5TC1272

Blinds controller for 230 V motors

Max power: 1250 VA

Local or centralised operating

Drive time adjustable from 1 to 120 sec.

Packing 1

Dimmers

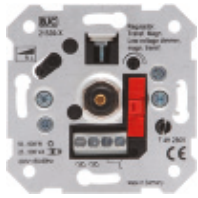

Two-way dimmer for RL loads (60 to 600 W) **21539-X**
 Two-way dimmer for incandescent (R), direct halogen (R) 60-600 W and halogen 12 V low voltage with ferromagnetic transformer (L) 25-500 VA.
 Fuse T 4 H 250 V
 Switch on / off by pressing
 Screw or claw fixing

Packing 1

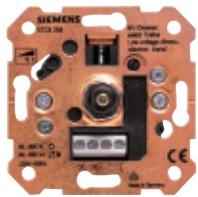

Two-way dimmer for RC loads (60 to 800 W) **21542-X**
 Two-way dimmer for incandescent (R), direct halogen (R) 60-800 W and low voltage halogens with electronic transformer (C) 20 to -800 VA
 Switch on / off by pressing
 Screw or claw fixing
 Electronic protection against short circuits

Packing 1



Electronic potentiometer for fluorescent lamps **21543-X**
 1 to 10 Vdc
 Potentiometer for fluorescent lamps with adjustable electronic ballast 920 VA, 50 mA (10 VDC)
 Maximum control current: 50 mA, 230 V, 4 A
 Fuse T 4 H 250 V
 Switch on / off by pressing. Screw or claw fixing

Packing 1

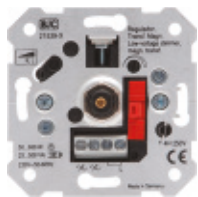

Two-way dimmer for LED lamps 230 Vac **21549-X**
 LED Lamps 6-60 W, incandescent, direct halogen (R) 6-120 W halogen 12 V low voltage with ferromagnetic transformer (L) 25-100 VA.
 Switch on / off by pressing
 1.6 Fuse T H 250 V.
 Screw or claw fixing
 List of compatibility-tested LED lamps is available at: www.bjces.com/documentation

Packing 1

COVER AND BUTTON



POLAR WHITE	ALUMINIUM M.	CARBON M.	MATT WHITE	MATT BLACK
5TC8900-0WH	5TC8900-0AM	5TC8900-0CM	5TC8900-0SW	5TC8900-0SB
59749-WH	59749-AM	59749-CM	59749-SW	59749-SB
1	1	1	1	1

Equivalent ref.
Packing

Note: Equivalent ref. is a valid reference for order entering (also available on the product package labelling).

Dimmers



Universal RLC dimmer

2385

Power supply voltage: 230V ~ 50Hz.
Consumption: 3VA.
Loads:
• Incandescent and halogen lamps (230V): 15 - 400W.
• Halogen Lamps with inductive transformer: 20 - 250W.
• Halogen lamps with electronic transformer: 15 - 400W.

Packing 1



Dimmer for LED lamps

2386

Power supply voltage: 230V ~ 50/60Hz.
Consumption: 2VA.
Valid for adjustable LED lamps:
• to 230V ~: 4-100W
• To 12V ~ with adjustable electronic transformer (1 lamp/ transformer): maximum 6 transformers (50W).

Packing 1



Dimmer for LED strip, monochrome (12-48 Vdc)

2387

Power supply voltage: 12 - 48V CC.
Consumption: <12mA.
Maximum Load 8A.
Minimum regulation level: 1% - 60%.
Regulation speed 0% to 100%: 3 - 10 s.

Packing 1



Dimmer for adjustable compact fluorescent lamps

2388

Power supply voltage: 230V ~ 50Hz.
Consumption: 3VA.
Load: min.20 - Max.200W.

Packing 1

Load connection

LOAD TYPE								
	Insert Type	230 V halogen lamps	Low voltage halogens 12 V (R) with ferromagnetic transformer (L)	Low voltage halogens lamps with electronic transformer (C)	LED Load 230 V	LED Strips, monochrome (12-48 Vdc)	Dimmable Compact Fluorescent Lamps (CFLs)	Electronic ballast with regulation Input of 1-10V
21539-X	Rotary	60-600 W	25-500 VA	NO	NO	NO	NO	NO
21542-X	Rotary	60-800 W	NO	60-800 VA	NO	NO	NO	NO
21543-X	Rotary	NO	NO	NO	NO	NO	NO	920 VA 50 mA (10 Vdc)
21549-X	Rotary	6-120 W	25-100 VA	NO	6-60 W	NO	NO	NO
2385	By push-button	15-400 W	20-250 VA	15-400 VA	NO	NO	NO	NO
2386	By push-button	NO	NO	4-300 W	4-100 W	NO	NO	NO
2387 *	By push-button	NO	NO	NO	NO	Maximum 8 A	NO	NO
2388	By push-button	NO	NO	NO	NO	NO	20 W - 200 W	NO

* 2387. The dimmer must be installed along with the 230Vac 12-48Vdc transformer that carries the LED strip. A list of compatibility-tested LED lamps is available at www.bj.es/documentation

Socket outlets with increased touch protection

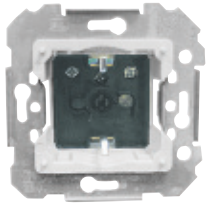

Schuko® socket outlet with increased touch protection **18524**
Screwed terminals
16 A 250 V~

Packing 10

SOCKET OUTLET COVER				
POLAR WHITE	ALUMINIUM M.	CARBON M.	MATT WHITE	MATT BLACK
5UH1072-4WH	5UH1072-4AM	5UH1072-4CM	5UH1072-4SW	5UH1072-4SB
Equivalent ref. 59724-WH	59724-AM	59724-CM	59724-SW	59724-SB
Packing 10	10	10	1	1

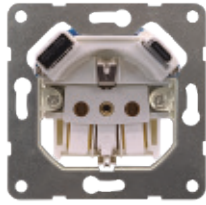

Schuko® socket outlet 2P+E with double USB **18524-USBC** **NEW**
type A and type C charger with fast charging with increased touch protection

- Schuko® socket:
- 230Vac 50Hz, 16A
- Screwless terminal
Double USB charger:
- 1 USB Type A socket and 1 USB Type C socket.
- Maximum power: 20W
- Quick charge Power Delivery USB C: 5V/3A; 9V/2.22A; 12V/1.67A
- Quick charge USB A fast charging: 5V/3A; 9V/2.22A; 12V/1.67A
- Normal charging:
· 5V/3.4A when using USB A and USB C at the same time
· 5V/2.4A when using USB A or USB C individually
- Short circuit protection
- Temperature protection

According to UNE 20315-1-1/1/1-2 and EN 62368-1 standards

Packing 1

SCHUKO® SOCKET OUTLET COVER				
POLAR WHITE	ALUMINIUM M.	CARBON M.	MATT WHITE	MATT BLACK
5UH1072-5WH10	5UH1072-5AM10	5UH1072-5CM10	5UH1072-5SW10	5UH1072-5SB10
Equivalent ref. 59724-USBC-WH	59724-USBC-AM	59724-USBC-CM	59724-USBC-SW	59724-USBC-SB
Packing 1 NEW	1 NEW	1 NEW	1 NEW	1 NEW

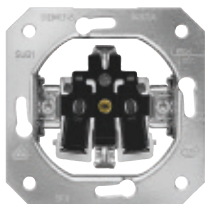

Schuko® socket outlet with screw-less terminals with claws **5UB1101-5B**
Schuko® socket outlet with screw-less terminals without claws **5UB1101-5KK**
For flexible or rigid 2.5mm cable

Packing 10

SCHUKO® SOCKET OUTLET COVER					
POLAR WHITE	ALUMINIUM M.	CARBON M.	MATT WHITE	MATT BLACK	ROJO
5UH1073-2WH	5UH1073-2AM	5UH1073-2CM	5UH1073-2SW	5UH1073-2SB	5UH1073-2RD
Equivalent ref. 59732-WH	59732-AM	59732-CM	59732-SW	59732-SB	59732-RD
Packing 10	10	10	1	1	1

SCHUKO® SOCKET OUTLET COVER WITH LABELLING FIELD		
POLAR WHITE	ALUMINIUM M.	CARBON M.
5UH1073-2WH01	5UH1073-2AM01	5UH1073-2CM01
Equivalent ref. -	-	-
Packing 1	1	1

SCHUKO® SOCKET OUTLET COVER WITH LABELLING FIELD AND OPERATING INDICATOR		
POLAR WHITE	ALUMINIUM M.	CARBON M.
5UH1073-2WH11	5UH1073-2AM11	5UH1073-2CM11
Equivalent ref. -	-	-
Packing 1	1	1

Note: Equivalent ref. is a valid reference for order entering (also available on the product package labelling).

Socket outlets with increased touch protection

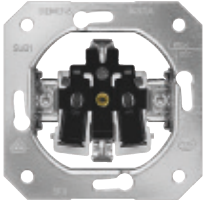

Schuko® socket outlet with screw-less terminals with claws **5UB1101-5B**
Schuko® socket outlet with screw-less terminals without claws **5UB1101-5KK**
 For flexible or rigid 2.5mm cable
 Packing 10

SOCKET OUTLET COVER WITH HINGED LID



	POLAR WHITE	ALUMINIUM M.	CARBON M.	MATT WHITE	MATT BLACK
Equivalent ref.	5UH1088-4WH	5UH1088-4AM	5UH1088-4CM	5UH1088-4SW	5UH1088-4SB
Packing	59814-WH 1	59814-AM 1	59814-CM 1	59814-SW 1	59814-SB 1

SOCKET OUTLET COVER WITH HINGED LID AND LABELLING FIELD



	POLAR WHITE	ALUMINIUM M.	CARBON M.
Packing	5UH1088-4WH01 2	5UH1088-4AM01 1	5UH1088-4CM01 1

SOCKET OUTLET COVER WITH LOCKABLE HINGED LID



	POLAR WHITE	ALUMINIUM M.	CARBON M.
Packing	5UH1073-2WH21 1	5UH1073-2AM21 1	5UH1073-2CM21 1



IP44 sealing kit for Schuko® socket outlets with hinged lid **5TG4318**
 Miro and Style
 Packing 1



Lamp for Schuko® socket outlet with operating indicator **5TG7304**
 1,5 mA, 230 V AC/ 50 Hz
 Packing 1

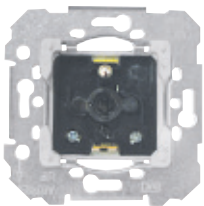

2 pole socket outlet with earth pin (French/Belgian standard) with increased touch protection **18572**
 Screwed terminals 16 A 250 V~
 Packing 10

SOCKET OUTLET COVER FOR FRENCH/BELGIAN STANDARD



	POLAR WHITE	ALUMINIUM M.	CARBON M.	MATT WHITE	MATT BLACK
Equivalent ref.	5UH1077-2WH	5UH1077-2AM	5UH1077-2CM	5UH1077-2SW	5UH1077-2SB
Packing	59772-WH 10	59772-AM 10	59772-CM 10	59772-SW 1	59772-SB 1

Note: Equivalent ref. is a valid reference for order entering (also available on the product package labelling).

IP44 switch solutions

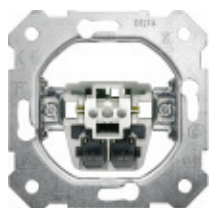

- One-way switch** **5TA2151**
- Two-way switch 16A** **5TA2156**
- Intermediate switch** **5TA2117**
- Pushbutton, 1 NO contact** **5TD2120**
- Pushbutton, 1 CO contact** **5TD2123**

Packing 1

For IP44 protection use of seal 5TG4324 is needed.

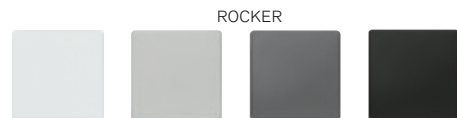

	POLAR WHITE	ALUMINIUM M.	CARBON M.	MATT BLACK
	5TG6201-0WH00	5TG6241	5TG6221	5TG6201-0SB00

Packing 1

These rockers are only suitable for IP44 (together with the corresponding seal) being used with the above indicated inserts. They are not suitable for MEC18 inserts

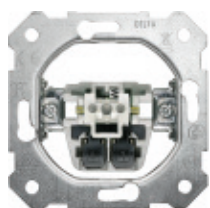

- Pushbutton, 1 NO contact** **5TD2120**
- Pushbutton, 1 CO contact** **5TD2123**

Packing 1

For IP44 protection use of seal 5TG4324 is needed.

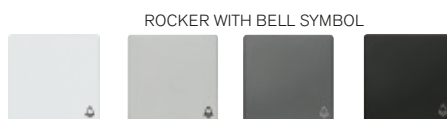

	POLAR WHITE	ALUMINIUM M.	CARBON M.	MATT BLACK
Bell logo	5TG6201-0WH10	5TG6247	5TG6227	5TG6201-0SB10
Packing	1	1	1	1
Bulb logo	5TG6201-0WH20	5TG6201-0AM20	5TG6201-0CM20	5TG6201-0SB20
Packing	1	1	1	1
Bulb logo and lens	5TG6201-0WH21	5TG6246	5TG6226	5TG6201-0SB21
Packing	1	1	1	1

These rockers are only suitable for IP44 (together with the corresponding seal) being used with the above indicated inserts. They are not suitable for MEC18 inserts

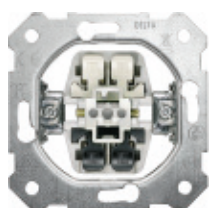

- ON/OFF switch, 2-pole, 10 A** **5TA2112**
- ON/OFF switch, 2-pole, 16 A** **5TA2162**
- ON/OFF switch, 3-pole, 16 A** **5TA2153**

Packing 1

For IP44 protection use of seal 5TG4324 is needed.



	POLAR WHITE	ALUMINIUM M.	CARBON M.	MATT BLACK
	5TG6201-0WH40	5TG6242	5TG6222	5TG6201-0SB40

Packing 1

These rockers are only suitable for IP44 (together with the corresponding seal) being used with the above indicated inserts. They are not suitable for MEC18 inserts

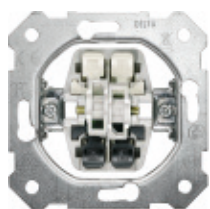

- Two-circuit switch** **5TA2155**
- Double two-way switch** **5TA2118**
- Pushbutton, double, 1 NO contact, 1 CO contact** **5TD2115**
- Pushbutton, double, 2 NO contacts** **5TD2111**

Packing 1

For IP44 protection use of seal 5TG4324 is needed.



	POLAR WHITE	ALUMINIUM M.	CARBON M.	MATT BLACK
	5TG6205-0WH00	5TG6245	5TG6225	5TG6205-0SB00

Packing 1

These rockers are only suitable for IP44 (together with the corresponding seal) being used with the above indicated inserts. They are not suitable for MEC18 inserts

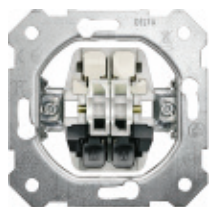

- Shutter/blind switch, with electrical and mechanical interlock** **5TA2154**
- Shutter/blind pushbutton, with electrical interlock** **5TA2114**

Packing 1

For IP44 protection use of seal 5TG4324 is needed.

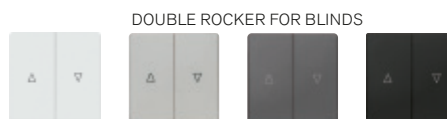

	POLAR WHITE	ALUMINIUM M.	CARBON M.	MATT BLACK
	5TG6214-0WH00	5TG6254	5TG6234	5TG6214-0SB00

Packing 1

These rockers are only suitable for IP44 (together with the corresponding seal) being used with the above indicated inserts. They are not suitable for MEC18 inserts



- IP44 set of seals, for inserts** **5TG4324**

Suitable for use only in conjunction with inserts and rockers in this page.

Packing 1

IP44 socket outlet solutions

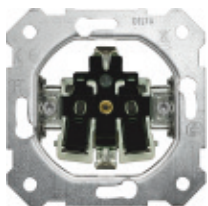

Schuko® socket outlet with screw-less terminals with claws **5UB1101-5B**

Schuko® socket outlet with screw-less terminals without claws **5UB1101-5KK**

For flexible or rigid 2.5mm cable

Packing 10

For IP44 protection use of seal 5TG4318 is needed.

SCHUKO® SOCKET OUTLET COVER WITH HINGED LID



POLAR WHITE ALUMINIUM M. CARBON M. MATT WHITE MATT BLACK

5UH1088-4WH **5UH1088-4AM** **5UH1088-4CM** **5UH1088-4SW** **5UH1088-4SB**

Equivalent ref.
Packing

59814-WH 59814-AM 59814-CM 59814-SW 59814-SB
1 1 1 1 1

SCHUKO® SOCKET OUTLET COVER WITH HINGED LID AND LABELLING FIELD



POLAR WHITE ALUMINIUM M. CARBON M.
5UH1088-4WH01 **5UH1088-4AM01** **5UH1088-4CM01**

Packing

2 1 1

SCHUKO® SOCKET OUTLET COVER WITH LABELLING FIELD AND OPERATING INDICATOR



POLAR WHITE ALUMINIUM M. CARBON M.
5UH1073-2WH21 **5UH1073-2AM21** **5UH1073-2CM21**

Packing

1 1 1



IP 44 sealing kit **5TG4318**

for Schuko® socket outlets with hinged lid

Miro and Style

Packing 1

Note: Equivalent ref. is a valid reference for order entering (also available on the product package labelling).

TV-FM-R/TV-SAT Socket outlets

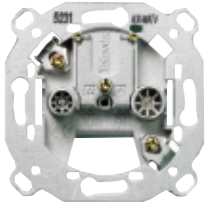

TV-FM socket outlet
Series 2-10 **2932**
Final outlet **2933**
Individual installation **2934**
 (Manufacturer TELEVÉS)

Packing 10
 TV-FM socket outlets are according to UNE 20523 and CEI 169-2 standards

Equivalent ref.
 Packing

R/TV - SAT COVER 2 OUTLETS



POLAR WHITE	ALUMINIUM M.	CARBON M.	MATT WHITE	MATT BLACK
5TG2561-0WH	5TG1253	5TG1223	5TG2561-0SW	5TG2561-0SB
59330-WH	59330-AM	59330-CM	59330-SW	59330-SB
10	1	1	1	1

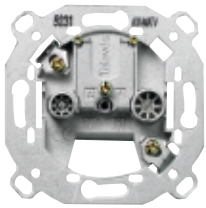

R/TV-SAT socket with 2 outlets
Series 6-12 **2921**
Series 2-5 **2922**
Final outlet **2923**
Individual installation **2924**
 (Manufacturer TELEVÉS)

Packing 10
 R/TV-SAT socket outlets are according to UNE 20523 and CEI 169-2 standards

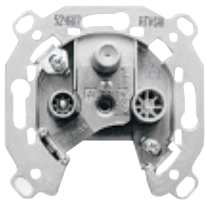

R/TV-SAT socket with 3 outlets **2918**
Individual installation
 (Manufacturer TELEVÉS)

Packing 1
 R/TV-SAT socket outlets conform to UNE-20523 and CEI 169-2 standards

Equivalent ref.
 Packing

R/TV - SAT COVER 3 OUTLETS



POLAR WHITE	ALUMINIUM M.	CARBON M.	MATT WHITE	MATT BLACK
5TG2548-2WH	5TG1252-2	5TG1222-2	5TG2548-2SW	5TG2548-2SB
59341-WH	59341-AM	59341-CM	59341-SW	59341-SB
1	1	1	1	1

Note: Equivalent ref. is a valid reference for order entering (also available on the product package labelling).

Voice and Data connectors and adapters, Type RJ

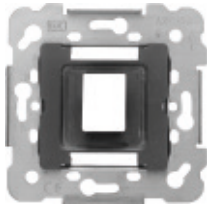

**Adapter for
1 RJ45/RJ11 connector
(AMP, ITT, etc.)**

19582-1

Packing 10

COVERS FOR 1 RJ CONNECTOR OR FIBRE



Equivalent ref.
Packing

POLAR WHITE	ALUMINIUM M.	CARBON M.	MATT WHITE	MATT BLACK
5TG2078-2WH01	5TG2078-2AM01	5TG2078-2CM01	5TG2078-2SW01	5TG2078-2SB01
59782-WH	59782-AM	59782-CM	59782-SW	59782-SB
10	1	1	1	1



**Adapter for
2 RJ11/RJ45 connectors**

19682-1

Packing 10

COVERS FOR DOUBLE RJ CONNECTOR OR FIBRE



Equivalent ref.
Packing

POLAR WHITE	ALUMINIUM M.	CARBON M.	MATT WHITE	MATT BLACK
5TG2078-2WH02	5TG2078-2AM02	5TG2078-2CM02	5TG2078-2SW02	5TG2078-2SB02
59882-WH	59882-AM	59882-CM	59882-SW	59882-SB
1	1	1	1	1



Keystone RJ45 connector Cat 6

3186-B

Cat. 6
White

Packing 25



Adapter with RJ11 connector
Tool-less connection

19582

Packing 10

COVERS FOR 1 RJ CONNECTOR OR FIBRE



Equivalent ref.
Packing

POLAR WHITE	ALUMINIUM M.	CARBON M.	MATT WHITE	MATT BLACK
5TG2078-2WH01	5TG2078-2AM01	5TG2078-2CM01	5TG2078-2SW01	5TG2078-2SB01
59782-WH	59782-AM	59782-CM	59782-SW	59782-SB
10	1	1	1	1



**Adapter with RJ45 connector
Cat 5E (ISO 8877)**

19595

Packing 10

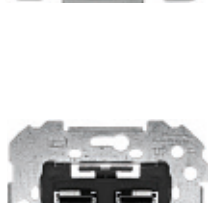

**Adapter with RJ45 connector
Cat 6**
Tool-less connection

18586

Packing 10

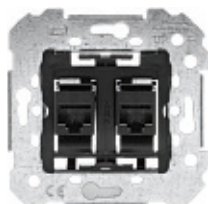

**Adapter with 2 RJ45 connectors
Cat. 6**

18586-2

Tool-less connection

Packing 1

COVERS FOR DOUBLE RJ CONNECTOR OR FIBRE



Equivalent ref.
Packing

POLAR WHITE	ALUMINIUM M.	CARBON M.	MATT WHITE	MATT BLACK
5TG2078-2WH02	5TG2078-2AM02	5TG2078-2CM02	5TG2078-2SW02	5TG2078-2SB02
59882-WH	59882-AM	59882-CM	59882-SW	59882-SB
1	1	1	1	1

Note: Equivalent ref. is a valid reference for order entering (also available on the product package labelling).

SC/APC fiber optic solutions

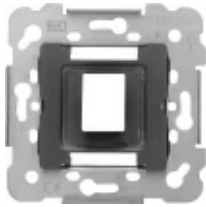

Adapter for 1 RJ connector standart Keystone

19582-1

Packing 10

COVERS FOR 1 RJ CONNECTOR OR FIBRE



	POLAR WHITE	ALUMINIUM M.	CARBON M.	MATT WHITE	MATT BLACK
Equivalent ref.	5TG2078-2WH01	5TG2078-2AM01	5TG2078-2CM01	5TG2078-2SW01	5TG2078-2SB01
Packing	10	1	1	1	1

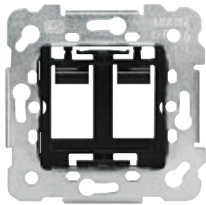

Adapter for 2 RJ connectors standart Keystone

19682-1

Packing 10

COVERS FOR DOUBLE RJ CONNECTOR OR FIBRE



	POLAR WHITE	ALUMINIUM M.	CARBON M.	MATT WHITE	MATT BLACK
Equivalent ref.	5TG2078-2WH02	5TG2078-2AM02	5TG2078-2CM02	5TG2078-2SW02	5TG2078-2SB02
Packing	1	1	1	1	1



Coupler for optical fibre connector Type SC/APC

3191

To be used with adapter 3190 or directly plugged in the RJ cover.
To be installed in increased depth flush-mounting box in order to respect the minimum bending radius of the fibre optic according to norm

Packing 20



Keystone adapter to be used with the coupler 3191 in RJ adapters

3190

For a proper use of this adapter an increased depth flush-mounting box is recommended.

Packing 20

Note: Equivalent ref. is a valid reference for order entering (also available on the product package labelling).

Voice and data connectors and adapters

Support plates for two computer connectors according to table.
Whitout claws

Packing 1



	Reference	Colour	Compatible connectors
	5TG2078	Red	<ul style="list-style-type: none"> - AMP-Type 216000-2 y 216005-4 - Krone MT-RJ 7023.1.303-xx, Cat. 6 STP 6830.1.312-xx, Cat. 6 UTP 6830.1.302-xx, Cat. 6 UTP 6830.1.800-xx, Cat. 6 UTP 6830.1.810-xx - Molex KSJ-00033-02/-04 - Radiall R 280 MOD 802/803/804/805/807 - Siemon MX-K-C5-80-ND/-02 ND - Telegärtner Cat.6 J00029A0036
	5TG2080	Black	<ul style="list-style-type: none"> - Leviton 41108, Cat. 5 - Panduit Keystone: KJ 688 Txx, Cat. 6, KJ 5e88 Txx, Cat. 5e - Brand Rex GPC Jack F01 3LF
	5TG2081	Yellow	<ul style="list-style-type: none"> - AMP-Tyco: 406372-x Cat. 5; 1116515-1 Cat. 5e; 1339015-1 Cat. 5e; 1375055-x Cat. 6; 1375187-x Cat. 6; 137188-1 Cat. 6; 1375189-1 Cat. 5e; 137190-x Cat. 5e; 137191-x Cat. 5e; 1375192-x Cat. 3 RJ11; 1375193-x Cat. 3 RJ11; 1116604-x Cat. 5e; 188650- 338038-1 .. 4; 1711342-1; MTRJ127841-1; MTRJ127842-1 - ASYCO Cat. 5e/6 SFTP - Kerpen E-Line 600 GG45 Cat. 6 Keystone clip Nr. 9ZE20009 - Nexans LENmark-MJ with keystone clip N429.620
	5TG2082	Orange	<ul style="list-style-type: none"> - Setec: SeSix 501244; UKJ 501292 - Rutenbeck 13900 300 - MMC: MK 6 NB; MK 6 AN; MK 6 FS - DANCHIEF 568 A/B, Cat. 5 - Radiall R280 MOD 809 y MOD 811 - Hubbel HXJ 5 EBU y UTP - BTR UTP 130 A 10 I
	5TG2083	Blue	<ul style="list-style-type: none"> - Krone Cat. 5 STP 6540.1.1 54.xx, Cat. 5; UTP 6540.1.130.xx; UTP 6540.1.100.xx
	5TG2084	Brown	<ul style="list-style-type: none"> - Siemon MX6-FS
	5TG2058	Green	<ul style="list-style-type: none"> - AVAYA Anixter Systimax (Lucent Techn.): M11...en M100 (uitloop), MPS100E Cat. 5, MPS200E + MGS 400 Cat. 6 - Gigaspeed: X10D MGS500, X10D MFP520 - R&M - R30511, -2, -3 y -4 with adapter 310694
	5TG2058-1	Transparent	To accommodate up to 2 Modular Lexcom Jack connectors.
	5TG2058-2	White	To accommodate up to 2 Modular Jack Plug-in Conn. Nordix/CDT 061110 ao 405302 + 3.
	5TG2058-3	Grey	To accommodate up to 2 Modular Lexcom Jack connectors.
	5TG2058-4	Silver	To accommodate up to 2 3M Volition modular jack connectors.
	5TG2098	Beige	<ul style="list-style-type: none"> - BTR: E-DAT module N°. 130910-I - Daetwyler: Unilan MS 1/8 Cat. 6 (equivalent to BTR jack)

Voice and data connectors and adapters

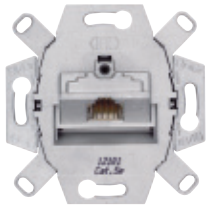

Adapter with RJ45 tilted connector Cat 6, shielded

Simple **5TG2026-1**
Double **5TG2026-2**

- Adjustable rear output cable (+/- 30°)
- LSA cable terminals 0.4 -0.63 mm Ø, AWG 26 -22
- Cat.6 / Class E according to DIN EN 60
- Connector tilted at 45°

Packing 1



Adapter with RJ45 tilted connector Cat 6, unshielded

Simple **5TG2027-1**
Double **5TG2027-2**

- LSA cable terminals 0.4 -0.63 mm Ø, AWG 26 -22
- Cat.6 / Class A according to ISO/IEC 11801:2011-06, DIN EN 50 173-1:2011-09, TIA/EIA-568-B.2-10 2008.
- Connector tilted at 45°

Packing 1

TITLED RJ CONNECTOR COVER, SINGLE/DOUBLE RUTENBECK



POLAR WHITE 5TG2545-0WH	ALUMINIUM M. 5TG1257	CARBON M. 5TG1227	MATT WHITE 5TG2545-0SW	MATT BLACK 5TG2545-0SB
Packing 1	1	1	1	1

TITLED RJ CONNECTOR COVER, SINGLE/DOUBLE RUTENBECK WITH LABELLING FIELD



POLAR WHITE 5TG2546-0WH	ALUMINIUM M. 5TG1258	CARBON M. 5TG1228
Packing 1	1	1

Multimedia connectors

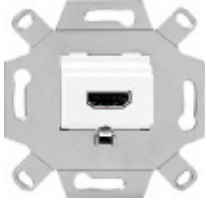

Type-A HDMI connector

Screwed terminals

White
Beige
Grey

18578-HDMI
18578-HDMI-A
18578-HDMI-G

Packing 1

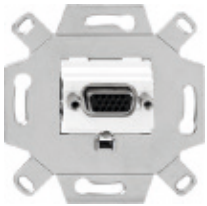

VGA connector

Maximum cable length 30 m.
(depending on the type of cables)

Screwed terminals

White
Beige
Grey

18578-VGA
18578-VGA-A
18578-VGA-G

Packing 1

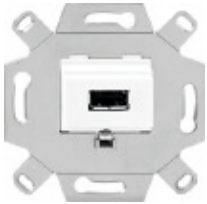

Type-A USB connector

Compatible with USB 2.0

Screwed terminals

White
Beige
Grey

18578-USB
18578-USB-A
18578-USB-G

Packing 1



Double USB charger

5TG2025-3

- Input rated voltage: 100-250V AC
- Nominal frequency: 50-60Hz
- 2 x USB type A female
- Output rated voltage: 5 V DC
- Max. total current: 2,1A
- Consumption on standby: < 100mW
- complies with the ErP European Directive
- Short circuit protection
- Temperature protection

Standards and certificates: EN 62386-1

Packing 1

Check availability

COVER FOR MULTIMEDIA CONNECTORS



Equivalent ref. Packing	POLAR WHITE 5TG2563-2WH 59778-WH	ALUMINIUM M. 5TG1256-2 59778-AM	CARBON M. 5TG1226-2 59778-CM	MATT WHITE 5TG2563-2SW 59778-SW	MATT BLACK 5TG2563-2SB 59778-SB
	1	1	1	1	1

COVER FOR DOUBLE USB CHARGER



Equivalent ref. Packing	POLAR WHITE 5TG2578-0WH 59780-WH	ALUMINIUM M. 5TG2578-0AM 59780-AM	CARBON M. 5TG2578-0CM 59780-CM	MATT WHITE 5TG2578-0SW 59780-SW	MATT BLACK 5TG2578-0SB 59780-SB
	1	1	1	1	1

Note: Equivalent ref. is a valid reference for order entering (also available on the product package labelling).

Sound







Loudspeaker connectors

Single
Stereo

5TG2467-2
5TG2468-2

Packing 1

COVER FOR MULTIMEDIA CONNECTORS

					
POLAR WHITE 5TG2563-2WH	ALUMINIUM M. 5TG1256-2	CARBON M. 5TG1226-2	MATT WHITE 5TG2563-2SW	MATT BLACK 5TG2563-2SB	
Equivalent ref. Packing	59778-WH 1	59778-AM 1	59778-CM 1	59778-SW 1	59778-SB 1

EGI* adapter

0708.10 White

TEZ* adapter

TX82/BL (White)

TX82/MF (Ivory)

TX82/GR (Grey)

SONELCO* adapter

PCP9135-01 (White)

PCP9135-10 (Ivory)

PCP9135-02 (Anthracite grey)

PCP9135-12 (Steel)

*References to be requested from each manufacturer



Sound potentiometer

3 W, 27 Ω, mono

5TG4815-0WH

Packing 1

Note: Equivalent ref. is a valid reference for order entering (also available on the product package labelling).

Room thermostats

Room thermostat

Monitoring and control of temperatures in enclosed rooms
 Sensor type: Bi-metal, Voltage: Vac; 24 Vac 50 Hz
 Maximum Load: 230Vac 10 A; 24Vac 1 A
 Operating temperature; 5 to 30°C (Numeral scale in steps of 6°C)

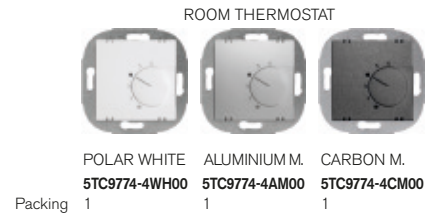

Heated floor, electronic thermostat

Electronic temperature control for heating systems, for example: electric heated floor systems, bathrooms, ceilings, marbles and heated walls.
 Voltage: 230 V ~, 50 Hz
 Sensor: external or internal & external (monitor).
 Floor sensor included in the package. Cutting capacity: 16(2) A
 Range: 10 to 50 °C (scale of 1 to 5)
 Indications (LEDs): heating up (Network), and eco mode activated (green).
 Extension of the sensor: up to 50 m only with 0.5 mm² cable, double insulated.
 Note: Ensure that the sensor cabling is contained in protective insulation. It is not possible to wire the sensor in parallel with AC power lines.

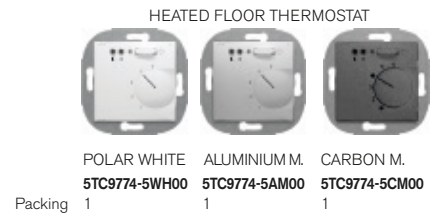

Heated floor Chronothermostat

Flush-mounted temperature and programmable time controller for electrical or hot water heating systems in rooms or heated floor (where actuators are normally closed). The device can be used as a room chronothermostat, as a room chronothermostat with floor temperature monitoring (using optional remote sensor), or as a floor chronothermostat (Remote sensor not included). This device has an adjustable weekly base timer switch with customisable programmes (the factory setting is for "normal" daily routines). Current: 230 V~, 50 Hz switching capacity: 10(2) / 230 V~ Sensor: NTC-internal (NTC can be connected as optional remote sensor) Ranges: - 5 to 30°C for ambient thermostat. -10 to 42°C for room thermostat. Battery life of 5 days without external power supply.



Motion detector



Spherical motion detector 3-wire mechanism **18555-3**

Contact rating (3-wire, relay output):
 Resistive load 2,300 W, 10 A max., cos φ = 1
 Inductive load 1,500 W, 5 A max., cos φ = 0.6
 Halogen with 1000 V transformer
 Electronic ballasts e.g. 2 x 36 W (20 max.)
 Compatible with LED loads

Packing 1



Buzzers and indicator lights



Buzzer module

- Polar white
- Aluminium metallic
- Carbon metallic

230V

Packing 1

5TG9875-8WH
5TG9875-8AM
5TG9875-8CM



	POLAR WHITE	ALUMINIUM M.	CARBON M.	MATT WHITE	MATT BLACK
	5TG2008-0WH	5TG2094	5TG2096	5TG2008-0SW	5TG2008-0SB
Packing	1	1	1	1	1



LED indicator light

90...240 V AC, 50/60 Hz
 1 W, vertical or horizontal position

- White
- Blue
- Red
- Green

Packing 1

5TG9880-3
5TG9880-4
5TG9880-5
5TG9880-6



	POLAR WHITE	ALUMINIUM M.	CARBON M.	MATT WHITE	MATT BLACK
	5TG2010-0WH	5TG2095	5TG2097	5TG2010-0SW	5TG2010-0SB
Packing	1	1	1	1	1

Other inserts

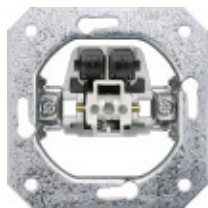

Push-button, normally-open contact

5TD2120

Packing 1

ROCKER FOR CORD OPERATED SWITCH



Packing 1 **POLAR WHITE**
5TG6217-0WH

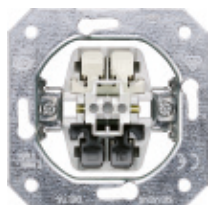

Push-button, changeover contact

5TD2123

Common to the entire DELTA-series

Packing 1

Blank cover

BLANK COVER



	POLAR WHITE	ALUMINIUM M.	CARBON M.	MATT WHITE	MATT BLACK
	5TG2558-0WH	5TG1250	5TG1220	5TG2558-0SW	5TG2558-0SB
Equivalent ref.	59033-WH	59033-AM	59033-CM	59033-SW	59033-SB
Packing	10	1	1	1	1

Cable output

CABLE OUTPUT



	POLAR WHITE	ALUMINIUM M.	CARBON M.	MATT WHITE	MATT BLACK
	5TG2566-0WH	5TG1251	5TG1221	5TG2566-0SW	5TG2566-0SB
Equivalent ref.	59734-WH	59734-AM	59734-CM	59734-SW	59734-SB
Packing	10	1	1	1	1

Intermediate frame for 51x51mm inserts

INTERMEDIATE FRAME FOR 51X51MM INSERTS



	POLAR WHITE	ALUMINIUM M.	CARBON M.
	5TG2557-0WH	5TG1160	5TG1150
Packing	1	1	1

Note: Equivalent ref. is a valid reference for order entering (also available on the product package labelling).

Flush-mounting boxes



Flush-mounting box 2373-I
Thermoplastic material
Dimensions: 71x71x43 mm
Packing 640



Protective cover 2374-I
Allows you to locate the box
after plastering
Packing 1000



Claws for metal frames 16-GAR
Bag with 50 claws and 50
screws
To mount 25 frames



Flush-mounting box 2341
**1 element for
plasterboard wall**
Packing 120



Flush-mounting box 2342
**2 elements for
plasterboard wall**
Packing 60



Flush-mounting box 2343
**3 elements for
plasterboard wall**
Packing 35



Flush-mounting box 2344
**4 elements for
plasterboard wall**
Packing 30



Flush-mounting box 2345
**5 elements for
plasterboard wall**
Packing 21



Hole saw hardened teeth shank for plasterboard wall 2158000
diam. 68mm
depth 40mm
Packing 1



Deburrer for Plasterboard 5892000 **NEW**
Ø 68 mm
Tool for flush installation
of hollow wall boxes
Packing 1





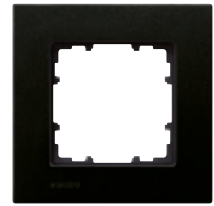

Replacement blades 5893000 **NEW**
for ref. 5892000
Packing 1

To achieve the designed installation results, the use of these boxes and the hole saw hardened teeth shank is recommended.





Miro thermoplastic frames



POLAR WHITE		Packing	ALUMINIUM METALLIC		Packing	CARBON METALLIC		Packing	MATT WHITE		Packing	MATT BLACK		Packing
	5TG1111-0WH 59001-WH	10	5TG1111-1 59001-AM	1	5TG1111-2 59001-CM	1	5TG1111-0SW 59001-SW	1	5TG1111-0SB 59001-SB	1				
	5TG1112-0WH 59002-WH	10	5TG1112-1 59002-AM	1	5TG1112-2 59002-CM	1	5TG1112-0SW 59002-SW	1	5TG1112-0SB 59002-SB	1				
	5TG1113-0WH 59003-WH	10	5TG1113-1 59003-AM	1	5TG1113-2 59003-CM	1	5TG1113-0SW 59003-SW	1	5TG1113-0SB 59003-SB	1				
	5TG1114-0WH 59004-WH	10	5TG1114-1 59004-AM	1	5TG1114-2 59004-CM	1	5TG1114-0SW 59004-SW	1	5TG1114-0SB 59004-SB	1				
	5TG1115-0WH 59005-WH	1	5TG1115-1 59005-AM	1	5TG1115-2 59005-CM	1	5TG1115-0SW 59005-SW	1	5TG1115-0SB 59005-SB	1				

Miro glass frames







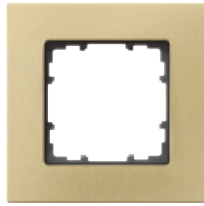

CRYSTAL GREEN		Packing	WHITE		Packing	BLACK		Packing	SAND		Packing	ORIENT RED		Packing
	5TG1201 59001-VG	1	5TG1201-1 59001-CB	1	5TG1201-2 59001-NE	1	5TG1201-4 59001-AE	1	5TG1201-3 59001-RO	1				
	5TG1202 59002-VG	1	5TG1202-1 59002-CB	1	5TG1202-2 59002-NE	1	5TG1202-4 59002-AE	1	5TG1202-3 59002-RO	1				
	5TG1203 59003-VG	1	5TG1203-1 59003-CB	1	5TG1203-2 59003-NE	1	5TG1203-4 59003-AE	1	5TG1203-3 59003-RO	1				
	5TG1204 59004-VG	1	5TG1204-1 59004-CB	1	5TG1204-2 59004-NE	1	5TG1204-4 59004-AE	1	5TG1204-3 59004-RO	1				
	5TG1205 59005-VG	1	5TG1205-1 59005-CB	1	5TG1205-2 59005-NE	1	5TG1205-4 59005-AE	1	5TG1205-3 59005-RO	1				

For correct installation of Miro frames in cavity walls, it is necessary to use the 2158000 or 5892000 hole saw (or equivalent) to make the recessing box flush with the wall.

Note: Equivalent ref. is a valid reference for order entering (also available on the product package labelling).





Miro pure aluminium frames



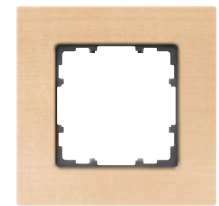
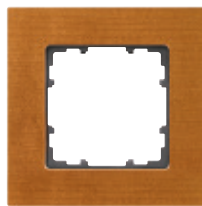
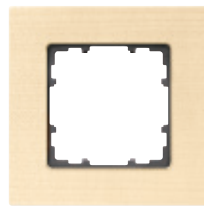
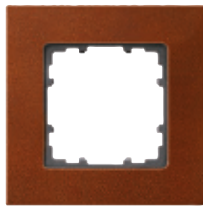



	ALUMINIUM	Packing	YELLOW OXID	Packing
	5TG1121-0 59001-AL	1	5TG1121-3 59001-AO	1
	5TG1122-0 59002-AL	1	5TG1122-3 59002-AO	1
	5TG1123-0 59003-AL	1	5TG1123-3 59003-AO	1
	5TG1124-0 59004-AL	1	5TG1124-3 59004-AO	1
	5TG1125-0 59005-AL	1	5TG1125-3 59005-AO	1

Miro solid wood frames



	MAPLE RED	Packing	MAPLE	Packing	CHERRY (TREATED COLOUR)	Packing	WENGE (TREATED COLOUR)	Packing	BEECH (TREATED COLOUR)	Packing
	5TG1101-2 59001-AJ	1	5TG1101-3 59001-AR	1	5TG1101-1 59001-CE	1	5TG1101-0 59001-WE	1	5TG1101-4 59001-HA	1
	5TG1102-2 59002-AJ	1	5TG1102-3 59002-AR	1	5TG1102-1 59002-CE	1	5TG1102-0 59002-WE	1	5TG1102-4 59002-HA	1
	5TG1103-2 59003-AJ	1	5TG1103-3 59003-AR	1	5TG1103-1 59003-CE	1	5TG1103-0 59003-WE	1	5TG1103-4 59003-HA	1
	5TG1104-2 59004-AJ	1	5TG1104-3 59004-AR	1	5TG1104-1 59004-CE	1	5TG1104-0 59004-WE	1	5TG1104-4 59004-HA	1

MEASUREMENTS

	90 x 90 mm
	90 x 161 mm
	90 x 232 mm
	90 x 303 mm

For correct installation of Miro frames in cavity walls, it is necessary to use the 2158000 or 5892000 hole saw (or equivalent) to make the recessing box flush with the wall.

Note: Equivalent ref. is a valid reference for order entering (also available on the product package labelling)

The BJC logo is presented in a white, rounded rectangular box with a black border, set against a dark background. The letters 'BJC' are in a bold, black, sans-serif font.

Viva

Simply Viva

Our lifestyles and dreams are changing. BJC presents the Viva collection, designed for young and practical people who are concerned about protecting the environment and adapting to the constantly changing environment.

A versatile series with a timeless design, based on simple lines and shapes. Designed and manufactured in Rubi, with BJC's quality standards, at a price adapted to the most competitive levels.



Polar White



Piano Black



Moon Silver



Lava Grey



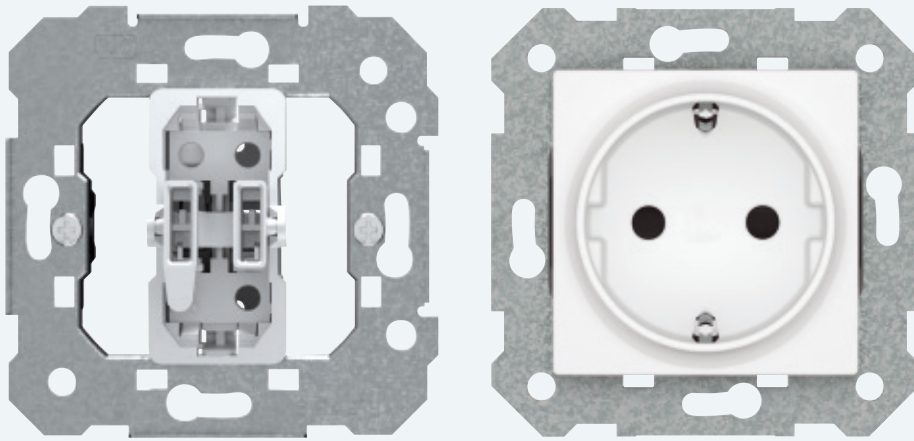

Viva was created to simplify installation processes. You can choose from two references: the mechanism + switch or cover, in a single reference, and the frame. The metal frame is adapted to all types of surfaces and features two grooves on both sides to help align different mechanisms. The frames fit into the fixing frame through the existing tabs, which have been specially designed to compensate uneven wall surfaces and to guarantee solid fixing and accurate and smooth finishes.

- Galvanised steel fixing frames with anti-corrosion treatment to ensure durable installation components.
- Fixing frames with upper and lower profiles to facilitate assembly and a rigid position of the mechanism.

Certifications



Choose the colour you like the most

Viva



Polar White



Sand Beige

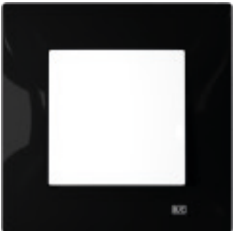

Piano Black



Stone Grey



Piano Black /
Moon Silver



Polar White /
Moon Silver

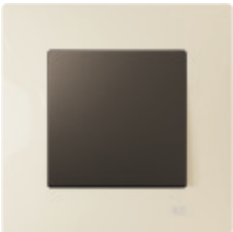

Sand Beige /
Lava Grey

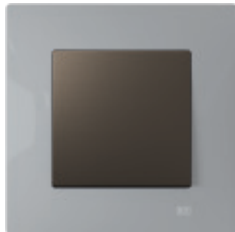

Stone Grey /
Lava Grey



Moon Silver



Lava Grey /
Moon Silver



Lava Grey



Moon Silver /
Lava Grey



Schuko® socket outlet + Frame
+ Surface Mounting Box



Switch + Schuko® socket outlet
+ Surface Mounting Box + Double frame

Viva is simplicity

The Viva series offers modern designs with simple lines and shapes, combining two colours on the frame and switch to create a differentiating touch. The frame can be selected in six different colours: black, white, grey, beige, moon silver and lava grey. The switch is available in white, silver or lava grey. Combinations to create a simple design and which can be easily adapted to today's decoration styles. The stylish design of the Viva series achieves the full integration of the mechanism on the wall.

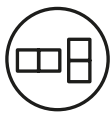

The same frame is used for horizontal and vertical installations.



Only two references. It is easy to choose a product of the Viva range.



Two grooves on each side of the metal frame help align different mechanisms.

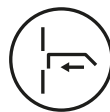
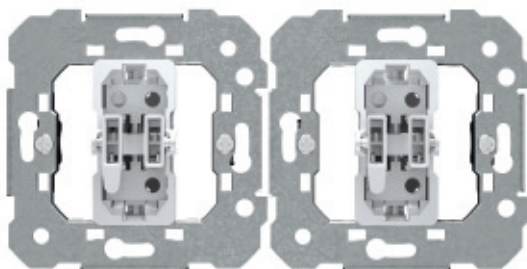

The frames fit into the fixing frame through the existing tabs, which have been specially designed to compensate uneven wall surfaces and to guarantee solid fixing and accurate and smooth finishes.





Cover for the socket outlet, with concealed screw. Quick and accurate fixing.



The modular surface mounting box can be used to create up to 4 elements, with the perfect integration of the series' aesthetics.



The frame can be fixed or extracted without the need to remove the switch.



Many different functions

The Viva series offers a wide range of functions to cater to today's needs. Light intensity dimmers, sound controllers and blind rolling up and down mechanisms. Choose the options you need, guaranteeing total comfort and enjoy our solutions' colourful and appealing designs. All functions are featured in the three series.



Dimmers

Dimmers are the perfect element create an atmosphere in rooms by adjusting the lighting levels to the desired intensity. The intensity can be increased or decreased. The power and technology of the different lamps requires using specific dimmers, adapted in each case to adjust the power levels. BJC offers a wide range of dimmers, suitable for different lamps and power ratings.



Chargers with double USB

The Schuko® socket with double USB Type A and Type C allows the simultaneous charging of two terminals while maintaining the usability of the socket. Quick and easy installation in a standard flush-mounted box.

- Power Delivery (required by EU by the end of 2024)
- Quick charge
- For standard flush-mounted box.



Multimedia

The multimedia connectors are the perfect solution to prevent exposed wiring in the installation and for the distribution of electronic devices in any type of installation; whether household or commercial. The HDMI, VGA, RJ45, stereo cable and other outputs can provide separate input and output sources, for efficient connections and uncluttered installations.

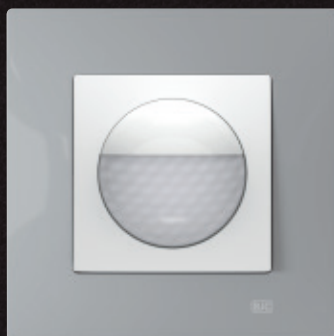

Motion detector

BJC's motion detector is an automatic light switching system that does not require direct activation to switch lights on or off, and it is always ready to detect the presence of people with its 180° detection angle. This practical and comfortable security solution also cuts costs. Its detection capacity cuts the costs of unnecessary lighting in transit areas and those left on by mistake or by children.

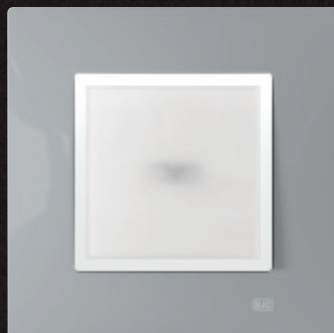

LED beacon light

The emergency beacon light is a practical and functional solution that allows you to use a hand-held lamp when you walk around the house after the lights have gone out due to an outage or breakdown. The beacon light is lit like an emergency lamp, so it can be easily accessed in dark spaces. It can also be removed and taken to a place where the lights can be turned on or to the distribution board.



Thermostats and chronothermostats

The thermostats can be used to control and adjust the temperature in each room. Simple settings to ensure comfort, in a climate control system designed with energy efficiency in mind.

A series intended to simplify the installation process.

It is suitable both for new buildings and for refurbishment projects, ensuring seamless integration.

Logistics and purchasing processes are simplified by using just two items. In addition, the frames can be mounted horizontally and vertically, with the added bonus that they can be attached or removed without the need to remove the rocker.



Insert+rocker

Metal frame that can be adapted to all types of surfaces. Two notches on both sides make it easy to align several inserts.



Frame

The frames fit into the metal frame via resistant tabs specially designed to compensate for irregularities in the walls and ensure a solid, precise finish.





Table for composing basic functions - Viva

Function	Insert + rocker	Frame
One-way switch	23505*	23001*
Two-way switch	23506*	23001*
Intermediate switch	23507*	23001*
Double one-way switch	23509*	23001*
Double two-way switch	23510*	23001*
Push-button bell symbol	23516-1*	23001*
Push-button bulb symbol	23516-2*	23001*
Dimmer	23549-X*	23001*
Schuko® socket	23524*	23001*
Schuko® + double USB Type A and Type C	23526-USBC*	23001*
TV/FM socket outlet	23330*	23001*
Adapter for 1 RJ connector	23682-1*	23001*
Adapter for 2 RJ connectors	23682-2*	23001*
Blank cover	23033*	23001*
Cable output	23534*	23001*
Buzzer	23536*	23001*
Key card switch	23068*	23001*







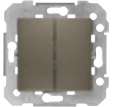

* For remaining colors add the extension color:

Colour	Rockers			Frames		
	Colour	Extension	Symbol	Colour	Extension	Symbol
	Polar White	-	●	Polar White	-	●
	Moon Silver	-PL	●	Stone Grey	-GP	●
	Lava Grey	-GL	●	Piano Black	-NP	●
				Beige	-A	●
				Moon Silver	-PL	●
				Lava Grey	-GL	●

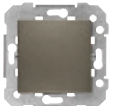
Switches

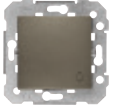
One-way switch Two-way switch Intermediate switch 2 pole one-way switch 16A 2 pole one-way switch 250 Vac	One-way switch 10 AX With claws 10 Without claws 10 Two-way switch 10 AX With claws 10 Without claws 10 Intermediate switch 10 AX With claws 6 Without claws 10 2 pole one-way switch 10 AX 1 One-way switch 16 AX 6 Two-way switch 16 AX 1 2 pole one-way switch 16 AX 1	  
		POLAR WHITE MOON SILVER LAVA GREY 23505-X 23505-PLX 23505-GLX 23505 23505-PL 23505-GL 23506-X 23506-PLX 23506-GLX 23506 23506-PL 23506-GL 23507-X 23507-PLX 23507-GLX 23507 23507-PL 23507-GL 23508 23508-PL 23508-GL 23557 23557-PL 23557-GL 23559 23559-PL 23559-GL 23558 23558-PL 23558-GL
Double one-way switch Double two-way switch Double intermediate switch 10 AX 250 Vac	Double one-way switch Packing With claws 10 Without claws 10 Double two-way switch With claws 10 Without claws 10 Double intermediate switch 1	  
		POLAR WHITE MOON SILVER LAVA GREY 23509-X 23509-PLX 23509-GLX 23509 23509-PL 23509-GL 23510-X 23510-PLX 23510-GLX 23510 23510-PL 23510-GL 23507-2 23507-2PL 23507-2GL

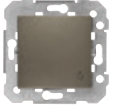
Push-buttons

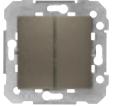
Push-button, Normally-open 10 A 250 Vac	Packing With claws 6 Without claws 10	  
		POLAR WHITE MOON SILVER LAVA GREY 23516-X 23516-PLX 23516-GLX 23516 23516-PL 23516-GL
Push-button, bell symbol 10 A 250 Vac	Packing With claws 6 Without claws 10	  
		POLAR WHITE MOON SILVER LAVA GREY 23516-1X 23516-1PLX 23516-1GLX 23516-1 23516-1PL 23516-1GL
Push-button, bulb symbol 10 A 250 Vac	Packing With claws 6 Without claws 10	  
		POLAR WHITE MOON SILVER LAVA GREY 23516-2X 23516-2PLX 23516-2GLX 23516-2 23516-2PL 23516-2GL
Double push-button 10 A 250 Vac	Packing Without claws 10	  
		POLAR WHITE MOON SILVER LAVA GREY 23511 23511-PL 23511-GL

Switches with indicator light

One-way switch with indicator light
 Two-way switch with indicator light
 Intermediate switch with indicator light
 Push-button with indicator light
 2 pole one-way switch

10 A 250 Vac

Note: In case you need to illuminate any of the white rocker switches of viva, you only need to install the indicator light and you can use the same standard white rocker.

One-way switch with indicator light	Packing
With claws	6
Without claws	6
Two-way switch with indicator light	Packing
With claws	6
Without claws	6
Intermediate switch with indicator light	Packing
With claws	1
Without claws	1
Push-button with indicator light	Packing
With claws	1
Without claws	1
2 pole one-way switch	Packing
Without claws	1

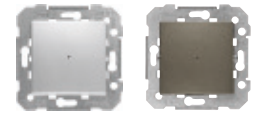

MOON SILVER	LAVA GREY
23505-PLLX	23505-GLLX
23505-PLL	23505-GLL
23506-PLLX	23506-GLLX
23506-PLL	23506-GLL
23507-PLLX	23507-GLLX
23507-PLL	23507-GLL
23516-PLLX	23516-GLLX
23516-PLL	23516-GLL
23558-PLL	23558-GLL

Double one-way switch
 Double two-way switch
 Double intermediate switch

10 A 250 Vac

Double one-way switch	Packing
With claws	1
Without claws	1
Double two-way switch	Packing
Without claws	1
Double intermediate switch	Packing
With claws	1
Without claws	1

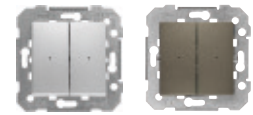

MOON SILVER	LAVA GREY
23509-PLLX	23509-GLLX
23509-PLL	23509-GLL
23507-2PLL	23507-2GLL
23510-PLLX	23510-GLLX
23510-PLL	23510-GLL

Push-buttons with indicator light

Push-button with indicator light, bell symbol

10 A 250 Vac

	Packing
With claws	1
Without claws	1

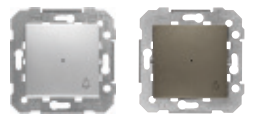

MOON SILVER	LAVA GREY
23516-1PLLX	23516-1GLLX
23516-1PLL	23516-1GLL

Push-button with indicator light, bulb symbol

10 A 250 Vac

	Packing	POLAR WHITE	Packing
With claws	6	23516-2LX	1
Without claws	6	23516-2L	1



MOON SILVER	LAVA GREY
23516-2PLLX	23516-2GLLX
23516-2PLL	23516-2GLL

Push-button with lighted labelling field

10 A 250 Vac

	Packing
With claws	1
Without claws	1



POLAR WHITE	MOON SILVER	LAVA GREY
23516-3LX	23516-3PLLX	23516-3GLLX
23516-3L	23516-3PLL	23516-3GLL

Indicator lights



**Blue LED indicator light
for single pole and 2 pole inserts** **21139-1**
230 V~ 1 mA
Packing 20



**Load for indicator lights with
energy saving and fluorescent lamps** **3139**
Packing 1



**Blue led indicator light for one-way switches,
two-way switches, intermediate switches
and push-buttons** **21139-2**
230 V~ 1 mA
Packing 20

Inserts for blinds

Double one-way switch for blinds
Double push-button for blinds



	Packing	POLAR WHITE	Packing	MOON SILVER	LAVA GREY
Double one-way switch for blinds					
With claws	6	23569-X	1	23569-PLX	23569-GLX
Without claws	6	23569	1	23569-PL	23569-GL
Double push-button for blinds	1	23565	1	23565-PL	23565-GL

Timer switch



Adjustable electronic timer switch **2382**

Power supply voltage: 230V ~ 50Hz

Consumption: 5VA

Valid for:

- Incandescent and halogen lamps (230V):
40 - 400W
- Halogen lamps with ferromagnetic transformer
50 - 320W
- Halogen lamps with electronic transformer:
40 - 400W
- Motors: 36-100W

Time adjustable from 30s to 10min

Packing 1

Dimmers

Dimmer for LED lamps 230 Vac

LED lamps 6-60 W, incandescent, direct halogen (R), 12 V halogen with ferromagnetic transformer (L) 6-120 W.
 Switch on / off by pressing.
 Screw or claw fixing.
 Fuse T 1.6 H 250 V.
 A list of compatibility-tested LED lamps is available at www.bjc.es/documentacion

Packing
1



Two-way dimmer for RL loads (50 to 600W)

Two-way dimmer switch for incandescent (R), direct halogen (R) 60-600 W and halogen 12 V low voltage with ferromagnetic transformer 25-500 VA.
 Fuse T 4 H 250 V.
 Switch on / off by pressing.
 Screw or claw fixing.

Packing
1



Two-way dimmer for RC loads (20 to 315W)

Two-way dimmer switch for incandescent (R), direct halogen (R) 20-315W and low-voltage halogens with electronic transformer (C) 20 to 315 VA.
 Fuse T 4 H 250 V.
 Switch on / off by pressing.
 Screw or claw fixing.

Packing
1



Dimmer for electronic ballast 1-10V

Potentiometer for fluorescent lamps with adjustable electronic ballast 920 VA, 50 mA (10 VDC) dc.
 Maximum control current: 50 mA. 230 V, 4 A 4 Fuse T H 250 V.
 Switch on / off by pressing.
 Screw or claw fixing.

Packing
1



Dimmers



Universal RLC dimmer
 Power supply voltage: 230V~ 50Hz.
 Consumption: 3VA.
 Loads:
 • Incandescent and halogen lamps (230V): 15 - 400W.
 • Halogen Lamps with inductive transformer: 20 - 250W.
 • Halogen lamps with electronic transformer: 15 - 400W.

2385

Packing 1



Dimmer for LED lamps
 Power supply voltage: 230V~ 50/60Hz.
 Consumption: 2VA.
 Valid for adjustable LED lamps:
 • to 230V~: 4-100W
 • To 12V~ with adjustable electronic transformer (1 lamp/ transformer): maximum 6 transformers (50W).

2386

Packing 1



Dimmer for LED strip, monochrome (12-48 Vdc)
 Power supply voltage: 12 - 48V CC.
 Consumption: <12mA.
 Maximum Load 8A.
 Minimum regulation level: 1% - 60%.
 Regulation speed 0% to 100%: 3 - 10 s.

2387

Packing 1



Dimmer for adjustable compact fluorescent lamps
 Power supply voltage: 230V~ 50Hz.
 Consumption: 3VA.
 Load: min.20 - Max.200W.

2388

Packing 1

Load connection

LOAD TYPE								
	Insert Type	230 V halogen lamps	Low voltage halogens 12 V (R) with ferromagnetic transformer (L)	Low voltage halogens lamps with electronic transformer (C)	LED Load 230 V	LED Strips, monochrome (12-48 Vdc)	Dimmable Compact Fluorescent Lamps (CFLs)	Electronic ballast with regulation Input of 1-10V
21539-X	Rotary	60-600 W	25-500 VA	NO	NO	NO	NO	NO
21542-X	Rotary	60-800 W	NO	60-800 VA	NO	NO	NO	NO
21543-X	Rotary	NO	NO	NO	NO	NO	NO	920 VA 50 mA (10 Vdc)
21549-X	Rotary	6-120 W	25-100 VA	NO	6-60 W	NO	NO	NO
2385	By push-button	15-400 W	20-250 VA	15-400 VA	NO	NO	NO	NO
2386	By push-button	NO	NO	4-300 W	4-100 W	NO	NO	NO
2387 *	By push-button	NO	NO	NO	NO	Maximum 8 A	NO	NO
2388	By push-button	NO	NO	NO	NO	NO	20 W - 200 W	NO

* 2387. The dimmer must be installed along with the 230Vac 12-48Vdc transformer that carries the LED strip. A list of compatibility-tested LED lamps is available at www.bj.es/documentation

Motion detector

Motion detector 3 wire insert

Contact capacity
(3 wire, relay output):
Resistive load 2300 W, 10 A max, $\cos \varphi = 1$
Inductive load 1500 W, 5 A max, $\cos \varphi = 0,6$
Halogen lamps with 1000 VA transformer
Electronic ballasts ex. 2x36 W (20 max.)
Compatible with LED loads

Packing
1



POLAR WHITE 23555-3 MOON SILVER 23555-3PL LAVA GREY 23555-3GL

Ceiling movement detectors



Ceiling detector, 360° range for flush mounting 2391

Power supply voltage: 230Vac 50Hz.
Consumption <1W.
Contact Capacity: 16A $\cos \varphi = 1$
Incandescent or halogen 230V: 3,000W
Halogen lamps with electronic transformer: 3,000W
Halogen lamps with ferromagnetic transformer: 2,400W
Fluorescence: 1.300W (130 μ F)
Fluo-compact: 18x7W, 12x11W, 10x15W, 10x20W, 10x23W.
Detection area: 7 m, 360°.
Compatible with LED lamps
Requires neutral connection.

Packing 1



Ceiling detector, 360° range for surface mounting 2390

Power supply voltage: 230Vac 50Hz.
Consumption <1W.
Contact Capacity: 16A $\cos \varphi = 1$
Incandescent or halogen 230V: 3,000W
Halogen lamps with electronic transformer: 3,000W
Halogen lamps with ferromagnetic transformer: 2,400W
Fluorescence: 1.300W (130 μ F)
Fluo-compact: 18x7W, 12x11W, 10x15W, 10x20W, 10x23W.
Detection area: 7 m, 360°.
Compatible with LED lamps
Requires neutral connection.

Packing 1

Socket outlets

Schuko® socket outlet with increased touch protection Screwed terminal

16 A 250 Vac

Packing
With claws 10
Without claws 10



POLAR WHITE 23524-X MOON SILVER 23524-PLX LAVA GREY 23524-GLX
23524 23524-PL 23524-GL



Packing
10

RED 23524-R

Schuko® 2P-T with double USB Type A and Type C charger with fast charging and increased touch protection

Schuko® socket:
- 230Vac 50Hz, 16A
- Screwless terminal
Double USB charger:
- 1 USB Type A socket and 1 USB Type C socket.
- Maximum power: 20W
- Quick charge Power Delivery USB C: 5V/3A; 9V/2.22A; 12V/1.67A
- Quick charge USB A fast charging: 5V/3A; 9V/2.22A; 12V/1.67A
- Normal charging:
· 5V/3.4A when using USB A and USB C at the same time
· 5V/2.4A when using USB A or USB C individually
- Short circuit protection
- Temperature protection
According to UNE 20315-1-1/1-1/1-2 and EN 62368-1 standards

Packing
1



POLAR WHITE 23526-USBC MOON SILVER 23526-USBC-PL LAVA GREY 23526-USBC-GL
NEW **NEW** **NEW**



Socket outlets

Schuko® socket outlet with increased touch protection Screw-less terminal

16 A 250 Vac

Packing

With claw 10
Without claw 10

Function not compatible with Viva frames installed in vertical position



POLAR WHITE 23526-1X
MOON SILVER 23526-1PLX
LAVA GREY 23526-1GLX
23526-1 23526-1PL 23526-1GL

Schuko® socket outlet with increased touch protection and hinged lid Screw-less terminal

16 A 250 Vac

Packing

With claw 6
Without claw 6



POLAR WHITE 23526-2X
MOON SILVER 23526-2PLX
LAVA GREY 23526-2GLX
23526-2 23526-2PL 23526-2GL

Schuko® socket outlet IP44 with increased touch protection and hinged lid Screw-less terminal

16 A 250 Vac

Packing

With claw 1
Without claw 1



POLAR WHITE 23526-3X
MOON SILVER 23526-3PLX
LAVA GREY 23526-3GLX
23526-3 23526-3PL 23526-3GL

2 pole with earth pin socket outlet (French/Belgian standard) with increased touch protection Screw-less terminal

16 A 250 Vac

Packing

With claw 10
Without claw 10



POLAR WHITE 23572-X
MOON SILVER 23572-PLX
LAVA GREY 23572-GLX
23572 23572-PL 23572-GL

2 pole with earth pin socket outlet (French/Belgian standard) with increased touch protection and hinged lid Screw-less terminal

16 A 250 Vac

Packing

With claw 6
Without claw 6



POLAR WHITE 23572-2X
MOON SILVER 23572-2PLX
LAVA GREY 23572-2GLX
23572-2 23572-2PL 23572-2GL

French plug socket with double USB Type A and Type C charger with fast charging and increased touch protection

Plug socket:

- 230Vac 50Hz, 16A

- Screwless terminal

Double USB charger:

- 1 USB Type A socket and 1 USB Type C socket

- Maximum power: 20W

- Quick charge Power Delivery USB C: 5V/3A; 9V/2.22A; 12V/1.67A

- Quick charge USB A fast charging: 5V/3A; 9V/2.22A; 12V/1.67A

- Normal charging:

· 5V/3.4A when using USB A and USB C at the same time

· 5V/2.4A when using USB A or USB C individually

- Short circuit protection

- Temperature protection

According to UNE 20315-1-1/1-2 and EN 62368-1 standards

Erp

Packing

8



POLAR WHITE 23772-USBC
MOON SILVER 23772-USBC-PL
LAVA GREY 23772-USBC-GL
NEW **NEW** **NEW**

Double - Schuko® monoblock with increased touch protection

White (similar to RAL9010)

For 60mm diameter enclosures

Clamp fixing

Screw clamping

Complete monoblock, no frame mounting required.

Packing

1



WHITE
EF-23924-4

25A Socket outlet



2P + E socket outlet **2225**
 White
 25 A 250 V~
 85x85x35 mm
 Accepts any 2P+E plug 25 A 250 V~
 S/UNE 20315
 The terminals hold cables up to 10 mm² in diameter.
 The box recommended for this socket outlet is Ref. 2373-I

Packing 5

Plug



2P+E plug White **2224-B**
25A 250 V

Packing 10

Voice and Data connectors and adapters, Type RJ

Adapter with RJ11 connector

Screw-less terminal

With claw
 Without claw

Packing
 6
 10



POLAR WHITE MOON SILVER LAVA GREY
23482-X **23482-PLX** **23482-GLX**
23482 **23482-PL** **23482-GL**

Adapter with RJ-45 Cat 6

Tool-less connection

With claw
 Without claw

Packing
 6
 10



POLAR WHITE MOON SILVER LAVA GREY
23586-X **23586-PLX** **23586-GLX**
23586 **23586-PL** **23586-GL**

Adapter with 2 RJ45 connectors Cat 6

Tool-less connection

With claw
 Without claw

Packing
 1
 1



POLAR WHITE MOON SILVER LAVA GREY
23586-2X **23586-2PLX** **23586-2GLX**
23586-2 **23586-2PL** **23586-2GL**

Adapter for 1 RJ 11/45 connector

Adapters compatible with RJ 45 in keystone format

With claw
 Without claw

Packing
 6
 10



POLAR WHITE MOON SILVER LAVA GREY
23682-1X **23682-1PLX** **23682-1GLX**
23682-1 **23682-1PL** **23682-1GL**

Adapter for 2 RJ 11/45 connectors

Adapters compatible with RJ 45 in keystone format

With claw
 Without claw

Packing
 6
 6



POLAR WHITE MOON SILVER LAVA GREY
23682-2X **23682-2PLX** **23682-2GLX**
23682-2 **23682-2PL** **23682-2GL**



Keystone RJ45 connector Cat 6 **3186-B**
 White
 Tool-less connection

Packing 25

SC/APC Optical fibre solutions

Adapter for 1 RJ 11/45 connector

Adapters compatible with RJ 45 in keystone format

With claw
Without claw

Packing
6
10



POLAR WHITE 23682-1X 23682-1	MOON SILVER 23682-1PLX 23682-1PL	LAVA GREY 23682-1GLX 23682-1GL
--	--	--

Adapter for 2 RJ 11/45 connectors

Adapters compatible with RJ 45 in keystone format

With claw
Without claw

Packing
6
6



POLAR WHITE 23682-2X 23682-2	MOON SILVER 23682-2PLX 23682-2PL	LAVA GREY 23682-2GLX 23682-2GL
--	--	--



Coupler for optical fibre connector Type SC/APC **3191**

To be used with adapter 3190 or directly plugged in the RJ cover.

Packing 20



Keystone adapter to be used with the coupler 3191 in RJ adapters **3190**

For a proper use of this adapter an increased depth flush-mounting box is recommended.

Packing 20

TV covers

TV front cover, 2 holes

Packing
10



POLAR WHITE **MOON SILVER** **LAVA GREY**
23330 **23330-PL** **23330-GL**

TV front cover, 3 holes

Packing
2



POLAR WHITE **MOON SILVER** **LAVA GREY**
23341 **23341-PL** **23341-GL**

TV-FM-R/TV-SAT socket outlets

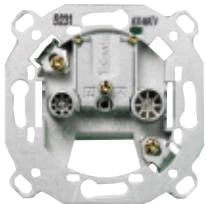

TV-FM socket outlets
Series 2-10 **2932**
Final outlet **2933**
Individual installation **2934**
(Manufacturer TELEVÉS)

Packing 10

TV-FM socket outlets are according to UNE 20523 and CEI 169-2 standards

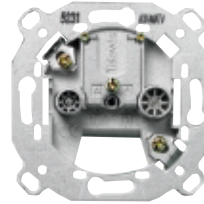

R/TV SAT socket with 2 outlets
Series 6-12 **2921**
Series 2-5 **2922**
Final outlet **2923**
Individual installation **2924**
(Manufacturer TELEVÉS)

Packing 10

TV-FM socket outlets are according to UNE 20523 and CEI 169-2 standards

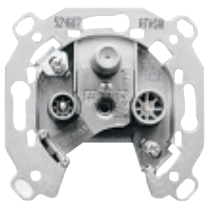

R/TV-SAT socket with 3 outlets
Individual installation **2918**
(Manufacturer TELEVÉS)

Packing 1

TV-FM socket outlets are according to UNE 20523 and CEI 169-2 standards

Blank covers and cable outputs

Blank cover

	Packing
With claw	6
Without claw	10



POLAR WHITE 23033-X 23033	MOON SILVER 23033-PLX 23033-PL	LAVA GREY 23033-GLX 23033-GL
---	--	--

Cable output

	Packing
With claw	6
Without claw	6



POLAR WHITE 23534-X 23534	MOON SILVER 23534-PLX 23534-PL	LAVA GREY 23534-GLX 23534-GL
---	--	--

Other inserts

Adjustable buzzer

230 Vac
Intermittent use

	Packing
With claw	6
Without claw	6



POLAR WHITE 23536-X	MOON SILVER 23536-PLX	LAVA GREY 23536-GLX
23536	23536-PL	23536-GL

Packing 1

LED beacon light

Led cold white 5000° K
230 Vac 0,4 W
5 Lm

Packing
1



POLAR WHITE 23531	MOON SILVER 23531-PL	LAVA GREY 23531-GL
-----------------------------	--------------------------------	------------------------------

LED beacon light

White warm LED, 3000° K
230 Vac 0,4 W
5 Lm

Packing
1



POLAR WHITE 23531-3	MOON SILVER 23531-3PL
-------------------------------	---------------------------------

Other LED colors on request

Multimedia inserts

Double USB charger

- Input rated voltage: 100-250V AC
 - Nominal frequency: 50-60Hz
 - 2 x USB type A female
 - Output rated voltage: 5 V DC
 - Max. total current: 2,1A
 - Consumption on standby: < 100mW
- complies with the ErP European Directive
- Short circuit protection
 - Temperature protection

Packing
1

Standards and certificates: EN 62386-1

Check availability



POLAR WHITE 23580 MOON SILVER 23580-PL LAVA GREY 23580-GL

Type-A USB connector

- Compatible with USB 2.0
Screwed terminals
It is recommended to tin the ends of the cable

Packing
1



POLAR WHITE 23578-USB MOON SILVER 23578-USB-PL LAVA GREY 23578-USB-GL

VGA connector

- Maximum cable length 30 m. (depending on the type of cables)
Screwed terminal
It is recommended to tin the ends of the cable

Packing
1



POLAR WHITE 23578-VGA MOON SILVER 23578-VGA-PL LAVA GREY 23578-VGA-GL

Type-A HDMI connector

- Screwed terminal
It is recommended to tin the ends of the cable

Packing
1



POLAR WHITE 23578-HDMI MOON SILVER 23578-HDMI-PL LAVA GREY 23578-HDMI-GL

Inserts and frames 55x55 mm

Key card switch

10 A 250 Vac



Packing 1 POLAR WHITE MOON SILVER LAVA GREY
23068 23068-PL 23068-GL

You can only install this insert together with 1-gang frame for 55x55 mm inserts

Room thermostat

Sensor type: Bi-metal, Voltage: Vac; 24 Vac 50 Hz
 Maximum Load: 230Vac 10 A; 24Vac 1 A
 Operating temperature; 5 to 30°C (Numeral scale in steps of 6°C)



Packing 1 POLAR WHITE MOON SILVER LAVA GREY
23144 23144-PL 23144-GL

You can only install this insert together with 1-gang frame for 55x55 mm inserts

Heated floor thermostat

Electronic temperature control for heating systems, for example: electric heated floor systems, bathrooms, ceilings, marbles and heated walls.
 Power supply voltage: 230 V ~, 50 Hz
 Sensor: external or internal & external (monitor).
 Floor sensor included in the package. Cutting capacity: 16(2) A
 Range: 10 to 50 °C (scale of 1 to 5)
 Indications (LEDs): heating up (Network), and eco mode activated (green).
 Extension of the sensor: up to 50 m only with 0.5 mm² cable, double insulated.
 Note: Ensure that the sensor cabling is contained in protective insulation. It is not possible to wire the sensor in parallel with AC power lines.



Packing 1 POLAR WHITE MOON SILVER LAVA GREY
23244 23244-PL 23244-GL

You can only install this insert together with 1-gang frame for 55x55 mm inserts

Chronothermostat

Flush-mounted temperature and programmable time controller for electrical or hot water heating systems in rooms or heated floors (where actuators are normally closed). The device can be used as a straightforward room chronothermostat, chronothermostat with floor temperature monitoring (using optional remote sensor), or as a floor chronothermostat (Remote sensor not included). This device has an adjustable weekly base timer switch timer with customisable programmes (the factory setting is for "normal" daily routines). Current: 230 V~, 50 Hz switching capacity: 10(2) / 230 V~
 Sensor: NTC-internal (NTC can be connected as optional remote sensor) Ranges: - 5 to 30°C for room thermostat. -10 to 42°C for floor thermostat. Battery life of 5 days without external power supply.



Packing 1 POLAR WHITE MOON SILVER LAVA GREY
23344 23344-PL 23344-GL

You can only install this insert together with 1-gang frame for 55x55 mm inserts

1-gang frame for 55x55 mm inserts



Packing 1 POLAR WHITE MOON SILVER
23201 23201-PL



Packing 1 LAVA GREY SAND BEIGE
23201-GL 23201-A



Packing 1 STONE GREY PIANO BLACK
23201-GP 23201-NP

Flush-mounting boxes



Flush-mounting box 2373-I
Thermoplastic material
Dimensions: 71x71x43 mm
Packing 640



Protective cover 2374-I
Allows you to locate the box after plastering
Packing 1000



Claws 16-GAR
for metal frames
Bag with 50 claws and 50 screws
To mount 25 frames



Flush-mounting box 2341
1 element for plasterboard wall
Packing 120



Flush-mounting box 2342
2 elements for plasterboard wall
Packing 60



Flush-mounting box 2343
3 elements for plasterboard wall
Packing 35



Flush-mounting box 2344
4 elements for plasterboard wall
Packing 30



Flush-mounting box 2345
5 elements for plasterboard wall
Packing 21



Hole saw hardened 2158000
teeth shank for plasterboard wall
diam. 68mm
depth 40mm
Packing 1



Deburrer for Plasterboard 5892000
Ø 68 mm **NEW**
Tool for flush installation of hollow wall boxes
Packing 1



Replacement blades 5893000
for ref. 5892000 **NEW**
Packing 1

Note: Check the price list published on our website, www.bjc.es, for availability of inserts with claws that are identified with -X after the reference. To achieve the designed installation results, the use of these boxes and the hole saw hardened teeth shank is recommended.

Surface box

PC-ASA. Resistant to UV rays and halogen free.
Fire-resistant. GWT 650°C.
RoHS.
Channel inlets 22x10, 16x10, 12x7 mm and
Tubes of diameters 25, 20 and 16 mm.
Dimensions of boxes once assembled:
1 part: 86x86x43 mm
2 parts: 157x86x43 mm
3 parts: 228x86x43 mm
4 parts: 299x86x43 mm

Packing 1

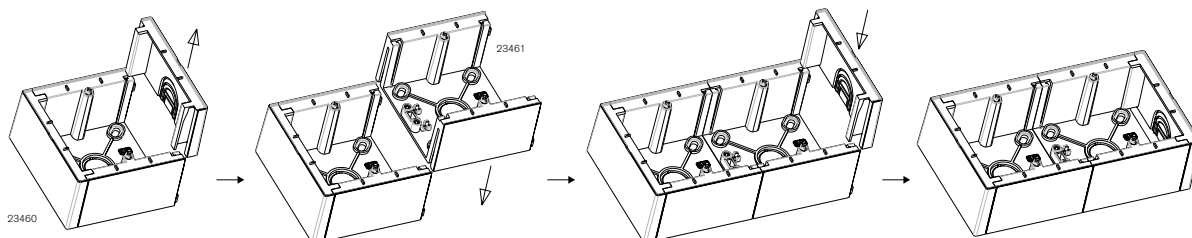

POLAR WHITE
23460



MOON SILVER
23460-PL



LAVA GREY
23460-GL

Modular surface box



23461



23461-PL

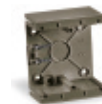

23461-GL

Modular extension unit

Frames

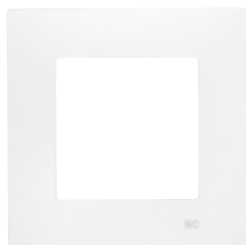

POLAR WHITE
Injected colour

Packing

	23001	12
	23002	12
	23003	6
	23004	6

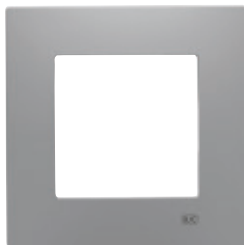

STONE GREY
Injected colour

Packing

	23001-GP	12
	23002-GP	12
	23003-GP	6
	23004-GP	6

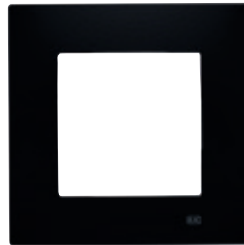

PIANO BLACK
Injected colour

Packing

	23001-NP	12
	23002-NP	12
	23003-NP	6
	23004-NP	6



SAND BEIGE
Injected colour

Packing

	23001-A	12
	23002-A	12
	23003-A	6
	23004-A	6



MOON SILVER
Painted colour

Packing

	23001-PL	12
	23002-PL	12
	23003-PL	6
	23004-PL	6



LAVA GREY
Painted colour

Packing

	23001-GL	12
	23002-GL	12
	23003-GL	6
	23004-GL	6

DIMENSIONS

	86 x 86 mm
	86 x 157 mm
	86 x 228 mm
	86 x 299 mm

Frames with Siemens logo



POLAR WHITE
Injected colour

Packing

	S23001	12
	S23002	12
	S23003	6
	S23004	6

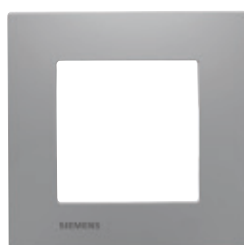

STONE GREY
Injected colour

Packing

	S23001-GP	12
	S23002-GP	12
	S23003-GP	6



MOON SILVER
Painted colour

Packing

	S23001-PL	12
	S23002-PL	12
	S23003-PL	6
	S23004-PL	6



LAVA GREY
Painted colour

Packing

	S23001-GL	12
	S23002-GL	12
	S23003-GL	6
	S23004-GL	6



Coral

**Your first house is there for
you to enjoy it**

Your first house needs brand new, easy to use and efficient equipment. Choose Coral, an affordable series with a wide range of options, which will allow you to enjoy the benefits of electricity from day one.



Because we all like to choose

Coral

Standard (frames with built-in embellisher)



White



Moon Silver



Shadow Grey

Frames for embellishers (in white, beige and painted)



White



Ocean Blue



Science Green



Wheat Yellow



Murano Red



Reflex Brown



Magic Black



Nickel



Matt Nickel



Gold



Matt Gold

Painted



Pearl Gold



Moon Silver



Shadow Grey



Lava Grey

The easiest option for installation

The ergonomic structure of the BJC Coral series ensures fast, easy, convenient installation.

Automatic connection of indicators lights.

Fast, safe connection

All mechanisms are fitted with the latest generation of automatic terminals, independent electrical inputs with greater coverage area for the cables. The flexible conductor is connected to the terminal by lightly pressing the disconnection levers, giving a firm fastening and perfect contact.

Perfect alignment

The lateral slots in the frame guarantee perfect alignment and positioning of the frames.

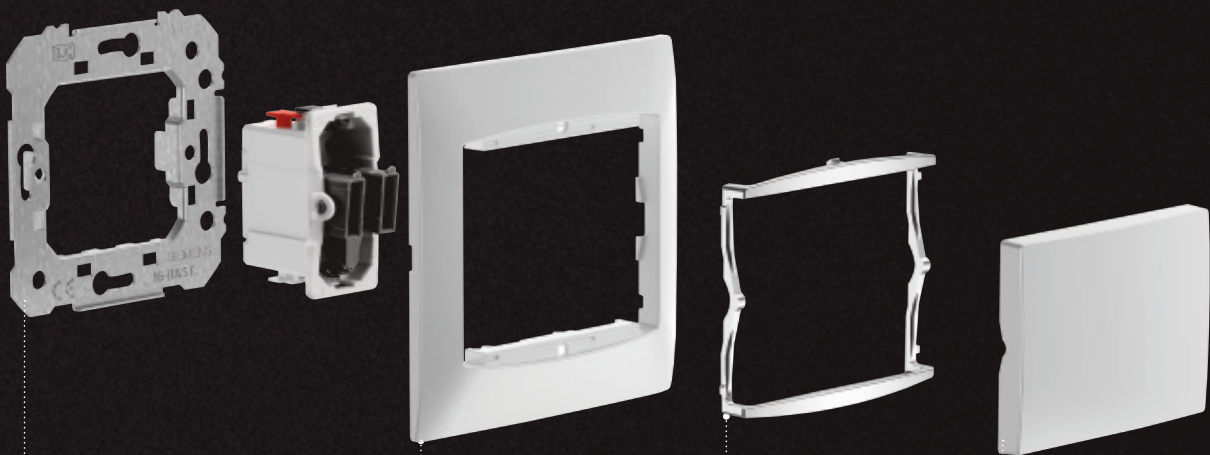

Insert

Silver contact insert (900/100) guarantees a high degree of conservation and level of service delivery. Automatic connection with independent contact.

Frame

Thermoset decorative frame.

Embellisher

12 different embellishers allow you to lend a touch of colour to the series. An ingenious solution ensuring a perfect fit into any setting.

Rocker

Rockers and covers manufactured in heatresistant, self-extinguishing thermoset resin.

Table for composing basic functions - Coral

Function	Insert	Switch/Cover	Frame with integrated embellisher	Frame + Colored embellisher
One-way switch	16505 + 16-BAST	21705*	21211*	21011* + 21600-*
Two-way switch	16506 + 16-BAST	21705*	21211*	21011* + 21600-*
Intermediate switch	16507 + 16-BAST	21705*	21211*	21011* + 21600-*
Double one-way switch	2 x 16505 + 16-BAST	21709*	21211*	21011* + 21600-*
Double two-way switch	2 x 16506 + 16-BAST	21709*	21211*	21011* + 21600-*
Bell push-button	16516 + 16-BAST	21716*	21211*	21011* + 21600-*
Bulb push-button	16516 + 16-BAST	21717*	21211*	21011* + 21600-*
Dimmer	21549-X	21749	21211*	21011* + 21600-*
Schuko® socket	21524	21724*	21211*	21011* + 21600-*
TV/FM socket outlet	---	21330*	21211*	21011* + 21600-*
Adapter for 1 RJ connector	19582-1	21795*	21211*	21011* + 21600-*
Adapter for 2 RJ connectors	19682-1	21882*	21211*	21011* + 21600-*
Blank cover	---	21133*	21211*	21011* + 21600-*
Cable output	18534	21734*	21211*	21011* + 21600-*
Buzzer	18535-B	21763*	21211*	21011* + 21600-*

* For remaining colors add the extension color:

Color	Switches and covers			Frame with integrated embellisher			Frame without integrated embellisher			Embellishers					
	White	-		White	-		White	-		White	-		Reflex Brown	-A	
	Pearl Gold	-DP		Shadow Grey	-GS		Pearl Gold	-DP		Nickel	-DP		Magic Black	-DP	
	Lava Grey	-GL		Moon Silver	-PL		Lava Grey	-GL		Matt Nickel	-GL		Ocean Blue	-GL	
	Shadow Grey	-GS					Shadow Grey	-GS		Gold	-GS				
	Moon Silver	-PL					Moon Silver	-PL		Matt Gold	-PL				
										Wheat Yellow	-				

Switches



One-way switch **16505**
Two-way switch **16506**
Intermediate switch **16507**

10 A 250 V~

One-way switch **16557**
Two-way switch **16559**

16 A 250 V~

One-way switch with control light **16605**
 10 A 250 V~

Packing 20

Packing 20	WHITE 21705	Packing 10	PEARL GOLD 21705-DP	LAVA GREY 21705-GL	SHADOW G. 21705-GS	MOON SILVER 21705-PL
Packing 20	WHITE 21705-L	Packing 10	PEARL GOLD 21705-DPL	LAVA GREY 21705-GLL	SHADOW G. 21705-GSL	MOON SILVER 21705-PLL

TRANSPARENT LENS



2 pole One-way switch **16508**
 10 A 250 V

2 pole One-way switch **16558**
 16 A 250 V

The same insert can be used with rockers for 2 pole inserts with indication light or 2 pole inserts with control lights, only by changing the installation diagram.

Packing 20

Packing 20	WHITE 21708	Packing 10	PEARL GOLD 21708-DP	LAVA GREY 21708-GL	SHADOW G. 21708-GS	MOON SILVER 21708-PL
Packing 20	WHITE 21708-L	Packing 10	PEARL GOLD 21708-DPL	LAVA GREY 21708-GLL	SHADOW G. 21708-GSL	MOON SILVER 21708-PLL

TRANSPARENT LENS

Push-buttons



Push-button **16516**
 10 A 250 V

Packing 20

Bell
Bulb

Packing 20	WHITE 21716	Packing 10	PEARL GOLD 21716-DP	LAVA GREY 21716-GL	SHADOW G. 21716-GS	MOON SILVER 21716-PL
Packing 20	WHITE 21717	Packing 10	PEARL GOLD 21717-DP	LAVA GREY 21717-GL	SHADOW G. 21717-GS	MOON SILVER 21717-PL

Bell
Bulb

Packing 20	WHITE 21716-L	Packing 10	PEARL GOLD 21716-DPL	LAVA GREY 21716-GLL	SHADOW G. 21716-GSL	MOON SILVER 21716-PLL
Packing 20	WHITE 21717-L	Packing 10	PEARL GOLD 21717-DPL	LAVA GREY 21717-GLL	SHADOW G. 21717-GSL	MOON SILVER 21717-PLL

TRANSPARENT LENS

Rocker with lighted labelling field

Packing 20	WHITE 21714	Packing 10	PEARL GOLD 21714-DP	LAVA GREY 21714-GL	SHADOW G. 21714-GS	MOON SILVER 21714-PL

Indicator lights



Blue LED indicator light for 2 pole inserts and control light **21139-1**
 230 V~ 1 mA
 Packing 20



Blue LED indicator light for one-way switches, two-way switches, intermediate switches and push-buttons **21139-2**
 230 V~ 1 mA
 Packing 20

Push-buttons

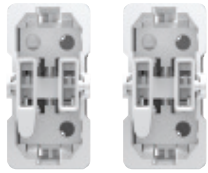

Double one-way switch **16505**
(using 2 one-way switches)

Double two-way switch **16506**
(using 2 two-way switches)

Double intermediate switch **16507**
(using 2 intermediate switches)

Double push-button **16516**
(using 2 push-buttons)

10 A 250 V~

Packing 20

Packing	WHITE	Packing	PEARL GOLD	LAVA GREY	SHADOW G.	MOON SILVER
20	21709	10	21709-DP	21709-GL	21709-GS	21709-PL
Packing	WHITE	Packing	PEARL GOLD	LAVA GREY	SHADOW G.	MOON SILVER
20	21709-L	10	21709-DPL	21709-GLL	21709-GSL	21709-PLL
	TRANSPARENT LENS					



Push-button with timed switch and indicator light **16599**

Power supply voltage: 230V~ 50Hz

Consumption: 5VA

Valid for:

- Incandescent and halogen 230V: 40 - 400W
 - Halogen lamps with ferromagnetic transformer: 50 - 320W
 - Halogen lamps with electronic transformer: 40 - 400W
 - Motors: 36-100W
- Adjustable timing from: 30s to 10 min.

Packing 1

Packing	WHITE	Packing	PEARL GOLD	LAVA GREY	SHADOW G.	MOON SILVER
20	21705-L	10	21705-DPL	21705-GLL	21705-GSL	21705-PLL
	TRANSPARENT LENS					

Claws 16-GAR for metal frames **16-GAR**



Bag with 50 claws and 50 screws to mount 25 frames

16-BAST
Metal frames

Packing 20

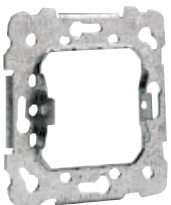

16-BAST-G
Metal frames with claws

Packing 10

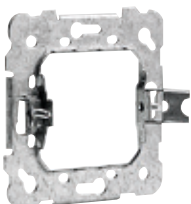

PRESENTATION:

All inserts require their corresponding metal frame for installation and assembly.

Example:

For installation of a single pole one-way switch without claws.

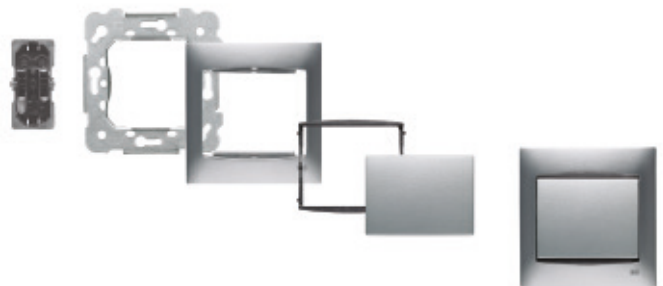

16505 + 16-BAST + 21011-PL + 21600-NIM + 21705-PL

Rotary switches

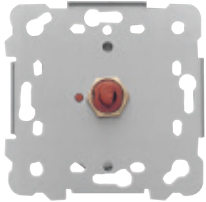

Rotary switch **18596**
 16A 250 V~
 Not suitable for claws

Packing 1

Applications: switching between fan speeds, fan coils, ...
 Four positions, three circuits.
 Connection by faston 6.3 x 0.8 mm.

SEQUENCE OF CONNECTIONS

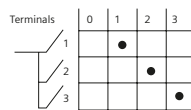

Packing 10
 WHITE
21796



Packing 10
 PEARL GOLD
21796-DP



LAVA GREY
21796-GL



SHADOW G.
21796-GS



MOON SILVER
21796-PL

Timer switches



Adjustable electronic timer switch **2382**

Power supply voltage :230V~ 50Hz
 Consumption: 5VA

Valid for:

- Incandescent and halogen lamps (230V):
40 - 400W
 - Halogen lamps with ferromagnetic transformer:
50 - 320W
 - Halogen lamps with electronic transformer:
40 - 400W
 - Motors: 36-100W
- Time adjustable from 30s to 10 min

Packing 1



Load for indicator lights with energy saving and fluorescent lamps **3139**

Packing 1

Inserts for blinds

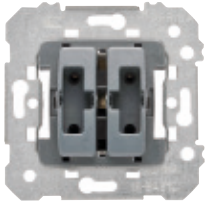

Double push-button for blinds with electrical interlocking device 18565

This insert is fitted with a mechanical safety system that prevents that the up/down signal could be received at the same time.

Double switch for blinds with electrical and mechanical interlocking device 18569

This insert is fitted with a mechanical safety system that prevents that the up/down signal could be received at the same time.
10 A 250 V





Packing 10



Blind control to be installed in flush-mounting box 5TC1272

Blinds controller for
230 V single-phase motors
Max power: 1250 VA
Local or centralised operating
Drive time adjustable from 1 to 120 sec.

Packing 1

						
Packing	WHITE	Packing	PEARL GOLD	LAVA GREY	SHADOW G.	MOON SILVER
20	21765	10	21765-DP	21765-GL	21765-GS	21765-PL

Note: Check the price list published on our website, www.bjc.es, for availability of inserts with claws that are identified with -X after the reference.

Dimmers



Two-way dimmer for RL loads (60 to 600 W) **21539-X**
 Two-way dimmer for incandescent (R), direct halogen (R) 60-600 W and halogen 12 V low voltage with ferromagnetic transformer (L) 25-500 VA.
 Fuse T 4 H 250 V
 Switch on / off by pressing
 Screw or claw fixing



Packing 1

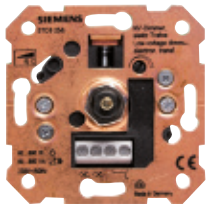

Two-way dimmer for RC loads (60 to 800 W) **21542-X**
 Two-way dimmer for incandescent (R), direct halogen (R) 60-800 W and low voltage halogens with electronic transformer (C) 20 to -800 VA.
 Switch on / off by pressing
 Screw or claw fixing
 Electronic protection against short circuits

Packing 1



Electronic potentiometer for fluorescent lamps **21543-X**
 1 to 10 Vdc
 Potentiometer for fluorescent lamps with adjustable electronic ballast 920 VA, 50 mA (10 VDC)
 Maximum control current: 50 mA. 230 V, 4 A
 Fuse T 4 H 250 V
 Switch on / off by pressing. Screw or claw fixing

Packing 1

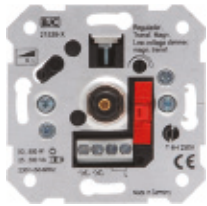

Two-way dimmer for LED lamps 230 Vac **21549-X**
 LED Lamps 6-60 W.
 incandescent, direct halogen (R) 6-120 W halogen 12 V low voltage with ferromagnetic transformer (L) 25-100 VA.
 Switch on / off by pressing
 1.6 Fuse T H 250 V.
 Screw or claw fixing

List of compatibility-tested LED lamps is available at:
www.bjc.es/documentacion

Packing 1

Dimmers



Universal RLC dimmer
 Power supply voltage: 230V ~ 50Hz.
 Consumption: 3VA.
 Loads:
 • Incandescent and halogen lamps (230V): 15 - 400W.
 • Halogen Lamps with inductive transformer: 20 - 250W.
 • Halogen lamps with electronic transformer: 15 - 400W.

2385

Packing 1



Dimmer for LED lamps
 Power supply voltage: 230V ~ 50/60Hz.
 Consumption: 2VA.
 Valid for adjustable LED lamps:
 • to 230V ~: 4-100W
 • To 12V ~ with adjustable electronic transformer (1 lamp/ transformer): maximum 6 transformers (50W).

2386

Packing 1



Dimmer for LED strip, monochrome (12-48 Vdc)
 Power supply voltage: 12 - 48V CC.
 Consumption: <12mA.
 Maximum Load 8A.
 Minimum regulation level: 1% - 60%.
 Regulation speed 0% to 100%: 3 - 10 s.

2387

Packing 1



Dimmer for adjustable compact fluorescent lamps
 Power supply voltage: 230V ~ 50Hz.
 Consumption: 3VA.
 Load: min.20 - Max.200W.

2388

Packing 1

Load connection

LOAD TYPE								
	Insert Type	230 V halogen lamps	Low voltage halogens 12 V (R) with ferromagnetic transformer (L)	Low voltage halogens lamps with electronic transformer (C)	LED Load 230 V	LED Strips, monochrome (12-48 Vdc)	Dimmable Compact Fluorescent Lamps (CFLs)	Electronic ballast with regulation Input of 1-10V
21539-X	Rotary	60-600 W	25-500 VA	NO	NO	NO	NO	NO
21542-X	Rotary	60-800 W	NO	60-800 VA	NO	NO	NO	NO
21543-X	Rotary	NO	NO	NO	NO	NO	NO	920 VA 50 mA (10 Vdc)
21549-X	Rotary	6-120 W	25-100 VA	NO	6-60 W	NO	NO	NO
2385	By push-button	15-400 W	20-250 VA	15-400 VA	NO	NO	NO	NO
2386	By push-button	NO	NO	4-300 W	4-100 W	NO	NO	NO
2387 *	By push-button	NO	NO	NO	NO	Maximum 8 A	NO	NO
2388	By push-button	NO	NO	NO	NO	NO	20 W - 200 W	NO

* 2387. The dimmer must be installed along with the 230Vac 12-48Vdc transformer that carries the LED strip. A list of compatibility-tested LED lamps is available at www.bjc.es/documentation

Socket outlets with increased touch protection

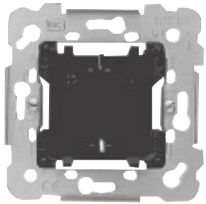

Schuko® socket outlet with increased touch protection 21524

Screwed terminals 16 A 250 V

Packing 10

Hinged lid for schuko® socket outlet



Packing 20
WHITE
21724



Packing 10
PEARL GOLD
21724-DP



21724-GL



21724-GS



21724-PL



Packing 10
WHITE
21813



Packing 10
PEARL GOLD
21813-DP



21813-GL



21813-GS



21813-PL

Special Identification (colour red)



Packing 10
21724-R

Schuko® socket outlet with increased touch protection (with BJC Coral frame built-in)

Screwed terminals 16 A 250 V~

Packing 10



Packing 10
BLANCO
21924

Socket outlet



2 pole with earth pin socket outlet (French/Belgian standard) With increased touchprotection 18571

16 A 250 V

Packing 10



Packing 10
WHITE
21771



Packing 10
PEARL GOLD
21771-DP



21771-GL



21771-GS



21771-PL

25A Socket outlets



2P+E socket outlet

25 A 250 V~ 85 x 85 x 35 mm
Accepts any 25 A 250 A 2P+E plug~/ MDS 20315
The box recommended for this socket outlet is Ref. 2373-I
Terminals accept cables up to 10mm²

Packing 5

White
2225

25A plugs



2P+E plug White
25 A 250 V~

Packing 10

White
2224-B

Other inserts



Buzzer
White 18535-B
Black 18535
Beige 18535-A

230 V~ 50 Hz
 Intermittent Use

Packing 10



Buzzer with tone regulation
White 18536-B
Black 18536
Beige 18536-A

230 V~ 50 Hz
 Intermittent Use

Packing 10



Pilot light 18530

Operates with E10 3W 230V bulb or equivalent LED.

The bulb is not supplied with the equipment.

Packing 10



LED beacon light
Cool white, 5000K 18531
Warm white, 3000K 18531-4

230 Vac 0,4 W
 5 Lm
 (Other colours available on request)

Packing 1



Other inserts



Cable output **18534**

With terminal 3 x 1.5 mm²
Cable Ø 10 mm maximum
Not suitable for claws

Packing 10



Cord operated push-button **18521**

Cord operated two-way switch **18598**

Insert not suitable for claws
10 A 250 V~

Packing 10



Fuse holder 16 to 250 V~ **18528**

For ceramic fuse 8.5x31.5 mm

Packing 10

Fuse-holder cap. 8,5x31,5 mm

Spare part for item 18528

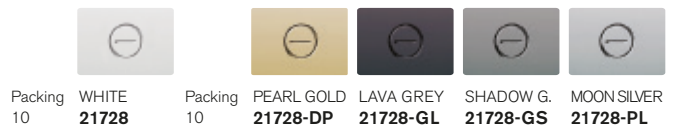

Timed key card switch **18668**

125-230 V~ 50/60 Hz
Resistive loads 10 A~ 16 A
Inductive loads 8 to $\cos \varphi = 0,4$
Disconnection delay 1 minute indicator
LED light
Insert not suitable for claws

Packing 1



Placa para tarjetero temporizado



**Assembling only on
these 1 gang frames**

Blank cover



Multimedia inserts



Double USB charger 5TG2025-3

- Input rated voltage: 100-250V AC
- Nominal frequency: 50-60Hz
- 2 x USB type A female
- Output rated voltage: 5 VDC
- Max. total current: 2,1A
- Consumption on standby: < 100mW
- complies with the ErP European Directive
- Short circuit protection
- Temperature protection

Standards and certificates: EN 62386-1

Packing 1

[Check availability](#)

					
Packing 1	WHITE 21780-USB	PEARL GOLD 21780-USB-DP	LAVA GREY 21780-USB-GL	SHADOW G. 21780-USB-GS	MOON SILVER 21780-USB-PL

RJ type connectivity terminals



Adapter with RJ11 connector 18482
Screwed terminals

Packing 10

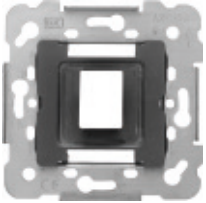
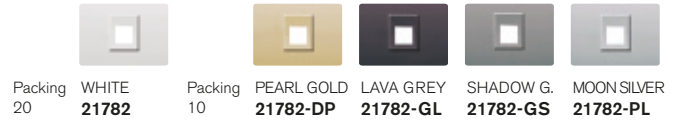

Adapter for 1 RJ connector 19582-1
standart Keystone

Packing 10

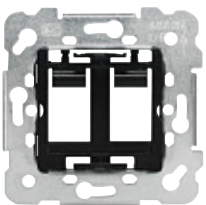
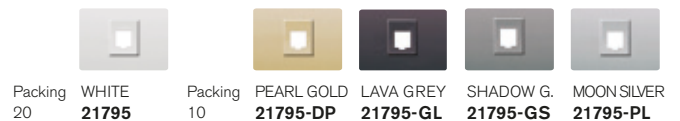

Adapter for 2 RJ connectors 19682-1
standart Keystone

Packing 10

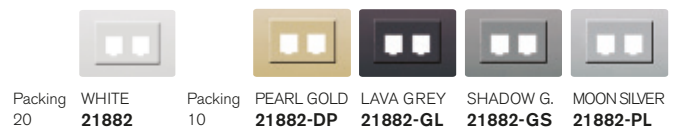

Keystone RJ45 connector Cat 6 3186-B

Cat. 6
White

Packing 25



Adapter with RJ11 connector 19582
Tool-less connection

Packing 10

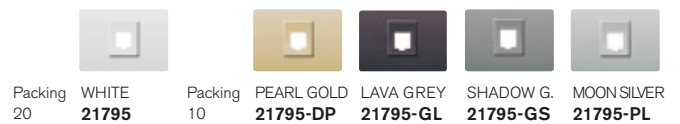

Adapter with RJ45 connector 19595
Cat 5E (ISO 8877)

Packing 10

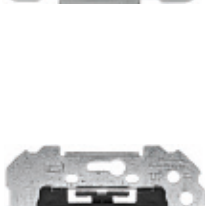

Adapter with RJ45 connector 18586
Cat 6

Tool-less connection

Packing 10

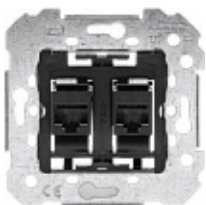

Adapter with 2 RJ45 connectors 18586-2
Cat. 6

Tool-less connection

Packing 1

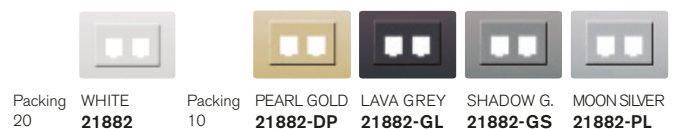

SC/APC fiber optic solutions



Adapter for 1 RJ connector standart Keystone 19582-1

Packing 10



Packing 20
WHITE 21882



Packing 10
PEARL GOLD 21882-DP



LAVA GREY 21882-GL



SHADOW G. 21882-GS



MOON SILVER 21882-PL

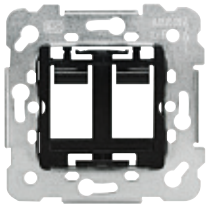

Adapter for 2 RJ connectors standart Keystone 19682-1

Packing 10



Packing 20
WHITE 21882



Packing 10
PEARL GOLD 21882-DP



LAVA GREY 21882-GL



SHADOW G. 21882-GS



MOON SILVER 21882-PL



Coupler for optical fibre connector Type SC/APC 3191

To be used with adapter 3190 or directly plugged in the RJ cover.

Packing 20



Keystone adapter to be used with the coupler 3191 in RJ adapters 3190

For a proper use of this adapter an increased depth flush-mounting box is recommended.

Packing 20

Loudspeakers socket outlets



Loudspeaker socket outlet (mono) **18563-2**
Rear screwed terminals

Packing 10



Packing 20
WHITE
21763



Packing 10
PEARL GOLD
21763-DP



LAVA GREY
21763-GL



SHADOW G.
21763-GS



MOON SILVER
21763-PL

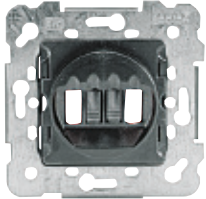

Loudspeaker socket outlet (stereo) **18563-4**
Rear screwed terminals

Packing 10

Loudspeakers socket outlets

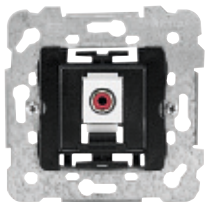

Mono RCA socket outlet **18575**
Rear screw-less terminal
Cable: maximum 3 pairs of 0.3 mm²

Packing 1



Packing 20
WHITE
21782



Packing 10
PEARL GOLD
21782-DP



LAVA GREY
21782-GL



SHADOW G.
21782-GS



MOON SILVER
21782-PL



Stereo RCA socket outlet **18576**
Rear screw-less terminal
Cable: maximum 3 pairs of 0.3 mm²

Packing 1



Packing 20
WHITE
21776



Packing 10
PEARL GOLD
21776-DP



LAVA GREY
21776-GL



SHADOW G.
21776-GS



MOON SILVER
21776-PL

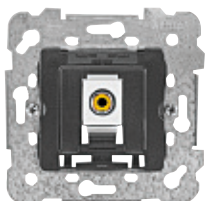

RCA video socket outlet **18577**
Rear screw-less terminal
Cable: maximum 3 pairs of 0.3 mm²

Packing 1



Packing 20
WHITE
21782



Packing 10
PEARL GOLD
21782-DP



LAVA GREY
21782-GL



SHADOW G.
21782-GS



MOON SILVER
21782-PL

Coiled potentiometer for loudspeakers



3 W 27 Ω **18560**
5 W 47 Ω **18562**
5+5 W 47 W* **18564**

Not suitable for claws
A deep flush-mounting box Ref 2364 is required

Packing 1



Packing 10
WHITE
21760



Packing 10
PEARL GOLD
21760-DP



LAVA GREY
21760-GL



SHADOW G.
21760-GS



MOON SILVER
21760-PL

Sonido

Adapters for SONBEL, EIS, TEZ and SONELCO sound modules.

☐ 46 x 46 mm



Packing 10
WHITE
21742



BLACK
21742-N

EGI sound adapter

Direct adaptation to the sound module fixing frames

☐ 41 x 41 mm



Packing 10
WHITE
21743



BLACK
21743-N

Room thermostat



Electronic thermostat for heating or cooling **18544**
 230 V~/1900 W $\cos \varphi = 1$
 230 V~/450 W $\cos \varphi = 0,6$
 Regulation from 5 °C a 30 °C
 Hysteresis ± 1 °C
 Packing 1



Packing 1
WHITE
21744



Packing 1
PEARL GOLD
21744-DP



LAVA GREY
21744-GL



SHADOW G.
21744-GS



MOON SILVER
21744-PL

Motion detector



Spherical motion detector 3-wire mechanism **18555-3**
 Contact rating (3-wire, relay output):
 Resistive load 2300 W, 10 A max., $\cos \varphi = 1$
 Inductive load 1500 W, 5 A max., $\cos \varphi = 0,6$
 Halogen lamps with transformer 1000 VA
 Electronic ballasts e.g. 2x36 W (20 max.)
 Compatible with LED loads
 Packing 1



Packing 20
WHITE
21763



Packing 10
PEARL GOLD
21763-DP



LAVA GREY
21763-GL



SHADOW G.
21763-GS



MOON SILVER
21763-PL

Spherical motion detector **18555**
 Not suitable for claws
 Detection angle 180° horizontal/60° vertical
 Time delay 4 s to 10 min
 Power supply 230 V +6%/-10
 Operating range (1.2-2.2 m installation height)
 max. 8 m for lateral movement, approx. 3 m for front movement
 Twilight level 5 to 1000 lux
 Contact rating (2-wire, triac output):
 - Incandescent/halogen 40-300 W max.
 Min. load 40 W
 Packing 1

Ceiling movement detectors



Ceiling detector, 360° range for flush mounting **2391**
 Power supply voltage: 230Vac 50Hz.
 Consumption <1W.
 Contact Capacity: 16A $\cos \varphi = 1$
 Incandescent or halogen 230V: 3,000W
 Halogen lamps with electronic transformer: 3,000W
 Halogen lamps with ferromagnetic transformer: 2,400W
 Fluorescence: 1.300W (130µF)
 Fluo-compact: 18x7W, 12x11W, 10x15W, 10x20W, 10x23W.
 Detection area: 7 m, 360°.
 Compatible with LED lamps
 Requires neutral connection.
 Packing 1



Ceiling detector, 360° range for surface mounting **2390**
 Power supply voltage: 230Vac 50Hz.
 Consumption <1W.
 Contact Capacity: 16A $\cos \varphi = 1$
 Incandescent or halogen 230V: 3,000W
 Halogen lamps with electronic transformer: 3,000W
 Halogen lamps with ferromagnetic transformer: 2,400W
 Fluorescence: 1.300W (130µF)
 Fluo-compact: 18x7W, 12x11W, 10x15W, 10x20W, 10x23W.
 Detection area: 7 m, 360°.
 Compatible with LED lamps
 Requires neutral connection.
 Packing 1

R/TV- SAT socket outlets

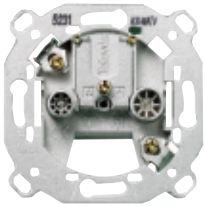

TV-FM socket outlets
Series 2-10 2932
Final outlet 2933
Individual installation 2934
 (Manufacturer TELEVÉS)

Packing 10

TV-FM socket outlets are according to UNE 20523 and CEI 169-2 standards

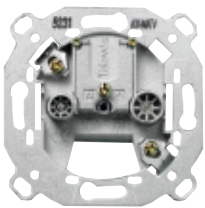

R/TV SAT socket with 2 outlets
Series 6-12 2921
Series 2-5 2922
Final outlet 2923
Individual installation 2924
 (Manufacturer TELEVÉS)

Packing 10

TV-FM socket outlets are according to UNE 20523 and CEI 169-2 standards



R/TV-SAT socket with 3 outlets
Individual installation 2918
 (Manufacturer TELEVÉS)

Packing 1

TV-FM socket outlets are according to UNE 20523 and CEI 169-2 standards



Frames with integrated embellishers



WHITE Packing



SHADOW GREY Packing



MOON SILVER Packing

	21211	10		21211-GS	10		21211-PL	10
	21212	10		21212-GS	10		21212-PL	10
	21213	5		21213-GS	5		21213-PL	5
	21214	5		21214-GS	5		21214-PL	5
	21312	10		21312-GS	10		21312-PL	10
	21313	5		21313-GS	5		21313-PL	5
	21314	5		21314-GS	5		21314-PL	5

Frames



WHITE Packing

21011	10
21012	10
21013	5
21014	5
21112	10
21113	5
21114	5



PEARL GOLD Packing

21011-DP	10
21012-DP	10
21013-DP	5
21014-DP	5
21112-DP	10
21113-DP	5
21114-DP	5



LAVA GREY Packing

21011-GL	10
21012-GL	10
21013-GL	5
21014-GL	5
21112-GL	10
21113-GL	5
21114-GL	5



SHADOW GREY Packing

21011-GS	10
21012-GS	10
21013-GS	5
21014-GS	5
21112-GS	10
21113-GS	5
21114-GS	5



MOON SILVER Packing

21011-PL	10
21012-PL	10
21013-PL	5
21014-PL	5
21112-PL	10
21113-PL	5
21114-PL	5

FRAME DIMENSIONS
Both vertical and horizontal

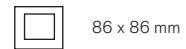

86 x 86 mm



86 x 157 mm



86 x 229 mm



86 x 300 mm

Embellishers

STANDARD

METAL COATING



WHITE
21600
Packing 10



GLOSS NICKEL
21600-NI
Packing 10



MATT NICKEL
21600-NIM
Packing 10



GLOSS GOLD
21600-OR
Packing 10



MATT GOLD
21600-ORM
Packing 10

METAL EFFECT



WHEAT YELLOW
21600-AT
Packing 10



REFLEX BROWN
21600-MR
Packing 10



MAGIC BLACK
21600-NG
Packing 10



OCEAN BLUE
21600-OC
Packing 10

Flush-mounting boxes



Flush-mounting box 2373-I
Thermoplastic material
Dimensions: 71x71x43 mm
Packing 640



Protective cover 2374-I
Allows you to locate the box after plastering
Packing 1000



Claws 16-GAR for metal frames
Bag with 50 claws and 50 screws
To mount 25 frames



Flush-mounting box 2341
1 element for plasterboard wall
Packing 120



Flush-mounting box 2342
2 elements for plasterboard wall
Packing 60



Flush-mounting box 2343
3 elements for plasterboard wall
Packing 35



Flush-mounting box 2344
4 elements for plasterboard wall
Packing 30



Flush-mounting box 2345
5 elements for plasterboard wall
Packing 21



Hole saw hardened teeth shank for plasterboard wall
diam. 68mm
depth 40mm
Packing 1



Deburrer for Plasterboard 5892000 **NEW**
Tool for flush installation of hollow wall boxes
Packing 1



Replacement blades 5893000 **NEW**
for ref. 5892000
Packing 1

To achieve the designed installation results, the use of these boxes and the hole saw hardened teeth shank is recommended.

Note: Check the price list published on our website, www.bjc.es, for availability of inserts with claws that are identified with -X after the reference. To achieve the designed installation results, the use of these boxes and the hole saw hardened teeth shank is recommended.

Surface box

PC-ASA. Resistant to UV rays and halogen free.
Fire-resistant. GWT 650°C.
RoHS.
Channel inlets 22x10, 16x10, 12x7 mm and
Tubes of diameters 25, 20 and 16 mm.
Dimensions of boxes once assembled:
1 part: 86x86x43 mm
2 parts: 157x86x43 mm
3 parts: 228x86x43 mm
4 parts: 299x86x43 mm

Packing 1

Modular surface box



POLAR WHITE 23460



MOON SILVER 23460-PL



LAVA GREY 23460-GL



23461



23461-PL



23461-GL

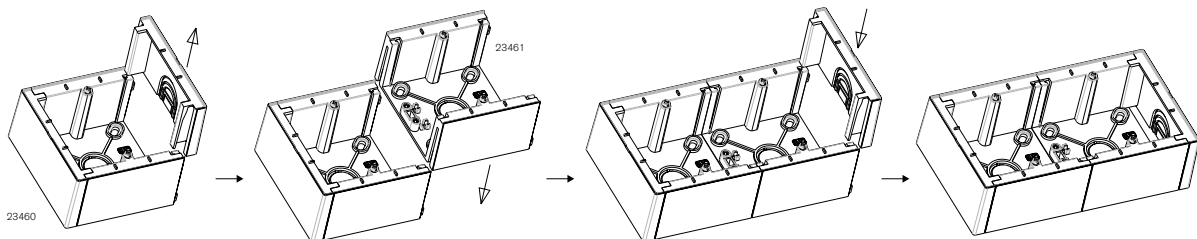



BJC

Sol

Light for your first spaces

A comprehensive solution at surprising prices and with incredible features. Choose the option that will illuminate your spaces best.



Choose your favourite colour

Sol



White



Silver Grey



Gold

Sol is an affordable series with surprising shiny and colourful finishes. A vibrant range of metallic colours with an attractive touch of light for your first spaces.

Easy assembly

Rockers and covers manufactured in heatresistant, self-extinguishing thermoset resin. Providing durability and security to all inserts.

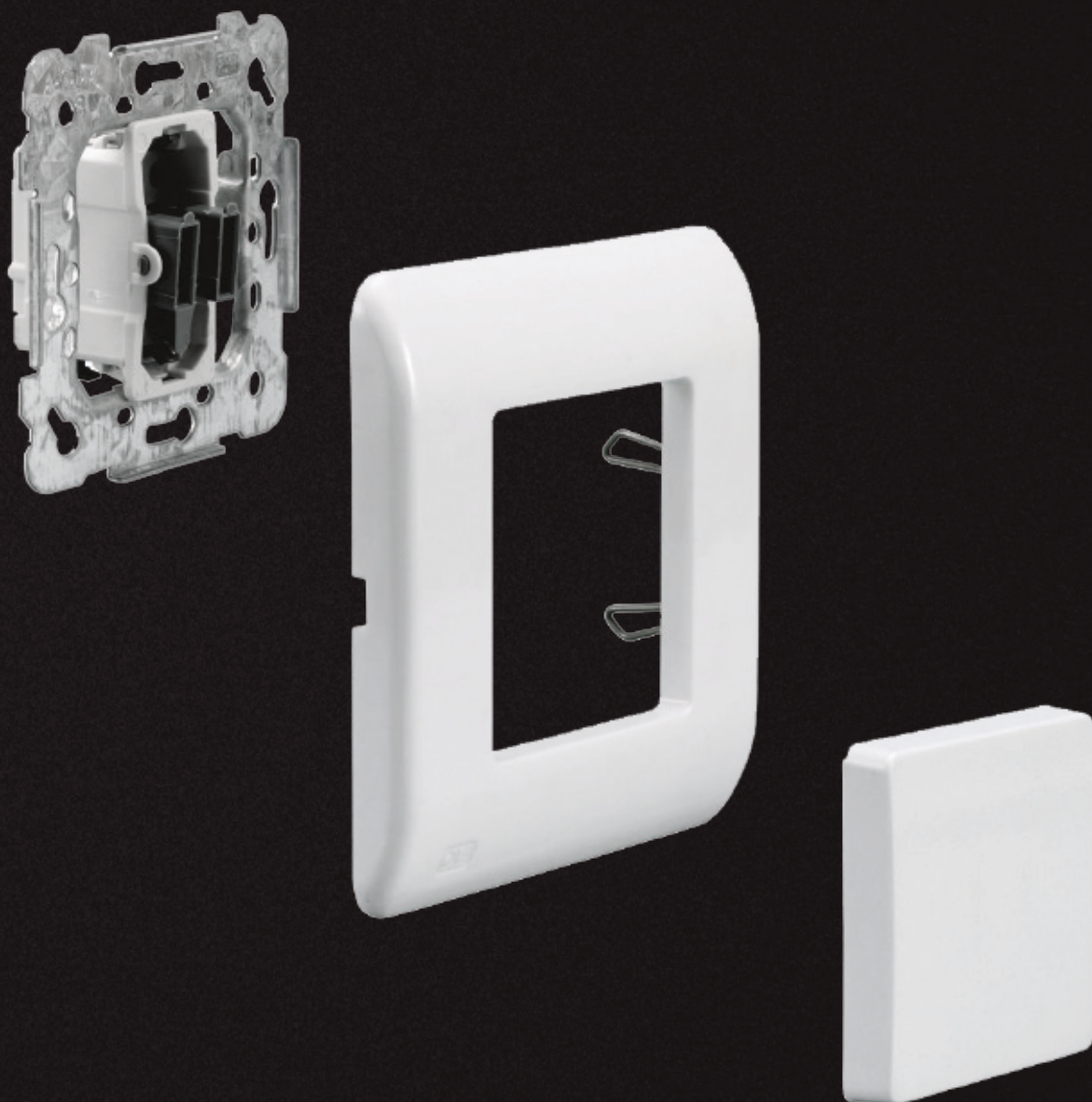







Table for composing basic functions - Sol

Function	Insert	Switch/Cover	Frame
One-way switch	16505	17705*	16311*
Two-way switch	16506	17705*	16311*
Intermediate switch	16507	17705*	16311*
Double one-way switch	2 x 16505	16705*	16311*
Double two-way switch	2 x 16506	16705*	16311*
Bell push-button	16516	17716*	16311*
Bulb push-button	16516	17717*	16311*
Schuko® socket	16524	16724*	16311*
TV/FM socket outlet	---	16330*	16311*
Adapter for 1 RJ connector	17095*		16311*
Adapter for 2 RJ connectors	17897*	17897*	16311*
Blank cover	16033*	16033*	16311*
Cable output	17034*	17034*	16311*
Key card switch	---	18068*	16311*

* For remaining colors add the extension color:

Colour	Switches/Covers			Frames		
	White	-		White	-	
Mahogany	-M		Silver Grey	-PL		
			Gold	-DR		

Switches



One-way switch **16505**
Two-way switch **16506**
Intermediate switch **16507**
One-way switch with control light **16605**
 10 A 250 V~

Packing 20

One-way switch **16557**
Two-way switch **16559**
 16 A 250 V~

Packing 20

NARROW ROCKERS



WITH LENS
 Packing WHITE MAHOGANY
 20 **16705-L** **16705-ML**



WITHOUT LENS
 Packing WHITE MAHOGANY
 20 **16705** **16705-M**

WIDE ROCKERS



WITH LENS
 Packing WHITE MAHOGANY
 20 **17705-L** **17705-ML**



WITHOUT LENS
 Packing WHITE MAHOGANY
 20 **17705** **17705-M**



2 pole one-way switch **16508**
 10 A 250 V~

Packing 20

The same insert can be used with rockers for 2 pole inserts with indication light or 2 pole inserts with control lights, only by changing the installation diagram

2 pole one-way switch **16558**
 16 A 250 V~

Packing 20

The same insert can be used with rockers for 2 pole inserts with indication light or 2 pole inserts with control lights, only by changing the installation diagram



WITH LENS
 Packing WHITE MAHOGANY
 20 **16708-L** **16708-ML**



WITHOUT LENS
 Packing WHITE MAHOGANY
 20 **16708** **16708-M**



WITH LENS
 Packing WHITE MAHOGANY
 20 **17708-L** **17708-ML**

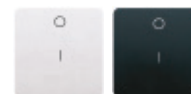

WITHOUT LENS
 Packing WHITE MAHOGANY
 20 **17708** **17708-M**

Push-buttons



Push-button **16516**
 10 A 250 V~

Packing 20

Bell
Lamp



WITH LENS
 Packing WHITE MAHOGANY
 20 **16716-L** **16716-ML**
 20 **16717-L** **16717-ML**

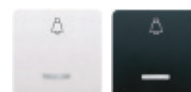

WITH LENS
 Packing WHITE MAHOGANY
 20 **17716-L** **17716-ML**
 20 **17717-L** **17717-ML**



Rocker with lighted labelling field
 Packing WHITE MAHOGANY
 20 **17714** **17714-M**

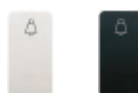

WITHOUT LENS
 Packing WHITE MAHOGANY
 20 **16716** **16716-M**
 20 **16717** **16717-M**

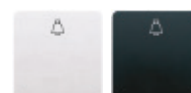

WITHOUT LENS
 Packing WHITE MAHOGANY
 20 **17716** **17716-M**
 20 **17717** **17717-M**

Other pictograms on request

Bell
Lamp

Indicator lights



**Blue LED indicator light for
2 pole inserts and control light** **21139-1**
230 V~ 1 mA
Packing 20



**Blue led indicator light for
one-way switches,
two-way switches,intermediate
switches and push-buttons** **21139-2**
230 V~ 1 mA
Packing 20



**Load for indicator lights with energy
saving and fluorescent lamps** **3139**
Packing 1

Inserts for blinds

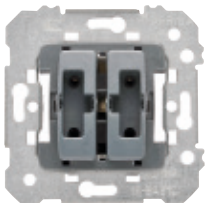

Double push-button for blinds **18565**
With electrical interlocking device
This insert is fitted with a mechanical safety system
that prevents that the up/down signal could be received
at the same time.

Switch for blinds **18569**
With electrical and mechanical interlocking device
This insert is fitted with a mechanical safety system
that prevents that the up/down signal could be received
at the same time.

10 A 250 V~

Packing 10



Packing 10
WHITE **17769**
MAHOGANY **17769-M**

Key operated inserts

WIDE ROCKERS



Two-way switch with key (removable) **18566**

Two-way switch with key (not removable) **18567**

5 A 250 V~
Intensity: 5 A (cos φ 0.7±1)
Voltage 250 V.
Contacts: 1 open, 1 closed
Terminals: silvered for welding
Protection: IP40. Supplied with 2 keys
Meets VDE standards

Packing 1



Packing 10
WHITE **17763**
MAHOGANY **17763-M**

Rotary switches

WIDE ROCKERS



Rotary switch **17596**

16 A 250 V~
Packing 1

4 positions, 3 circuits
Connection by faston 6.3 x 0.8 mm.
Insert without claws

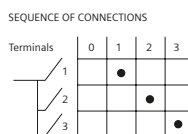

Packing 10
WHITE **17796**
MAHOGANY **17796-M**

Socket outlets

NARROW ROCKERS



2P Socket outlet **16522**

10 A 250 V~
Packing 20
FOR Ø 4 mm PINS ONLY



Packing 20
WHITE **16722**
MAHOGANY **16722-M**



2P+E socket outlet (displaced earth connection) **16525**

10 A 250 V~
Packing 20
FOR Ø 4 mm PINS ONLY



Packing 20
WHITE **16725**
MAHOGANY **16725-M**

Socket outlets with increased touch



Schuko® socket outlet **16524**
with increased touch protection
 Screwed terminals
 16 A 250 V
 Packing 10

WIDE ROCKERS

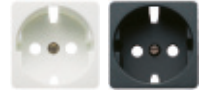

Packing 10 **WHITE** **MAHOGANY**
16724 **16724-M**



Identification for special circuits

Packing 10 **RED**
16724-R

Pre-assembled inserts Socket outlets

NARROW ROCKERS

2 pole double standard socket outlet
For European plugs
 10/16 A 250 V~
For American plugs
 15 A 125 V~



Packing 20 **WHITE** **MAHOGANY**
16090 **16090-M**

2 pole + E double standard socket outlet 2P+E mixed
For European plugs
 10/16 A 250 V~
For American plugs
 15 A 125 V~



Packing 20 **WHITE** **MAHOGANY**
16190 **16190-M**

Dimmers

WIDE ROCKERS

Dimmer for Sol Teide and Room metal frames

Packing 1

Two-way dimmer switch for incandescent (R), direct halogen (R) 50-600 W and halogen 12 V low voltage with ferromagnetic transformer (L) 25-500 VA.
Fuse T 4 H 250 V
Switch on / off by pressing
Screw or claw fixing



Packing 1
WHITE **16038**
MAHOGANY **16038-M**

Timer switch



Adjustable electronic timer switch **2382**

Power supply voltage: 230V~ 50Hz
Consumption: 5VA
Loads:
• Incandescent and halogen 230V: 40 - 400W
• Halogen lamps with ferromagnetic transformer: 50 - 320W
• Halogen lamps with electronic transformer: 40 - 400W
• Motors: 36-100W
Time adjustable from 30s to 10 min
Packing 1

Dimmers



Universal RLC dimmer **2385**

Power supply voltage: 230V~ 50Hz.
Consumption: 3VA.
Loads:
• Incandescent and halogen lamps (230V): 15 - 400W.
• Halogen Lamps with inductive transformer: 20 - 250W.
• Halogen lamps with electronic transformer: 15 - 400W.

Packing 1



Dimmer for LED lamps **2386**

Power supply voltage: 230V~ 50/60Hz.
Consumption: 2VA.
Valid for adjustable LED lamps:
• to 230V~: 4-100W
• To 12V~ with adjustable electronic transformer (1 lamp/ transformer): maximum 6 transformers (50W).

Packing 1



Dimmer for LED strip, monochrome (12-48 Vdc) **2387**

Power supply voltage: 12 - 48V CC.
Consumption: <12mA.
Maximum Load 8A.
Minimum regulation level: 1% - 60%.
Regulation speed 0% to 100%: 3 - 10 s.

Packing 1



Dimmer for adjustable compact fluorescent lamps **2388**

Power supply voltage: 230V~ 50Hz.
Consumption: 3VA.
Load: min.20 - Max.200W.

Packing 1

Other inserts

NARROW ROCKERS

WIDE ROCKERS

Cable output

The clamp holds up to 8 mm Ø cable



Packing 20 WHITE **16034** MAHOGANY **16034-M**

Packing 10 WHITE **17034** MAHOGANY **17034-M**



LED beacon light

White, 6000° K **18531**

Cool light, 6000° K **18531-4**

230 Vac 0,4 W

5 Lm

(Other colours available on request)

No cover required

Packing 1

Voice and Data connectors and adapters

NARROW ROCKERS

WIDE ROCKERS

RJ11 connector

Screwed terminals



Packing 20 WHITE **16082** MAHOGANY **16082-M**

Packing 10 WHITE **17082** MAHOGANY **17082-M**

RJ45 connector Cat 5E

Screwed terminals

For BJC Sol 1-gang frame only



Packing 20 WHITE **16095** MAHOGANY **16095-M**

Packing 10 WHITE **17095** MAHOGANY **17095-M**

Voice and Data connectors and adapters

WIDE ROCKERS

Adapter for 2 RJ45 connectors
(AMP, ITT, etc.) in BJC Sol metal frames



Packing	WHITE	MAHOGANY
10	17897	17897-M

Potentiometer for loudspeakers

WIDE ROCKERS



Potentiometer 3 W 27 Ω **18560**
 Potentiometer 5 W 47 Ω **18562**
 *Potentiometer 5+5 W 47 W **18564**

*A deep flush-mounting box is required

Packing 1



Packing	WHITE	MAHOGANY
10	17760	17760-M

Other inserts

NARROW ROCKERS

WIDE ROCKERS

Fuse holder

For glass fuse 5x20 mm



Packing
20

WHITE
16028

MAHOGANY
16028-M



Packing
10

WHITE
17028

MAHOGANY
17028-M

Fuse-holder cap

Spare parts for articles
Ref. 16028 and 17028



Packing
10

WHITE
14129



Packing
10

WHITE
14129



Glass fuse 5x20 mm

4 A **498-4**

6 A **498-6**

10 A **498-10**

Packing 100

Pre-assembled inserts

NARROW ROCKERS

Blank cover



Packing
20

WHITE
16033

MAHOGANY
16033-M

R/TV-SAT socket outlet

WIDE ROCKERS

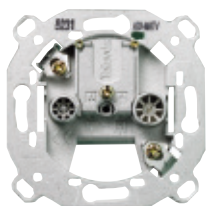

TV-FM socket outlet
Series 2-10 **2932** 45x45 mm covers for TV-FM of BJC or TELEVES
Final outlet **2933**
Individual installation **2934**

(Manufacturer TELEVÉS)
 Packing 10

Signal outputs for TV and FM comply with UNE 20523 and CEI standards 169-2

Adapter 4x2"
For American box **16337**



Packing 10 **WHITE** **MAHOGANY**
 16330 **16330-M**



Packing 10 **WHITE** **MAHOGANY**
 16331 **16331-M**

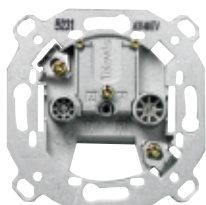

R/TV-SAT socket with 2 outlets
Series 6-12 **2921** 45x45 mm covers for R/TV-SAT outlets by BJC or TELEVÉS
Series 2-5 **2922**
Final outlet **2923**
Individual installation **2924**

(Manufacturer TELEVÉS)
 Packing 10

Signal outputs for TV and FM comply with UNE 20523 and CEI standards 169-2

Adapter 4x 2"
for American box **16337**



Packing 10 **WHITE** **MAHOGANY**
 16320 **16320-M**



Packing 10 **WHITE** **MAHOGANY**
 16321 **16321-M**

Metal frames



Claws **16-GAR**
For metal frames

Bag with 50 claws and 50 screws to mount 25 frames

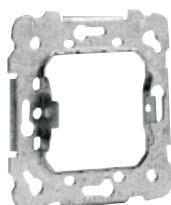

16-BAST
Metal frame

Packing 20

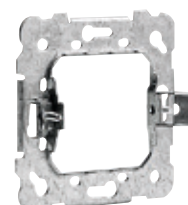

16-BAST-G
Metal frame with claws

Packing 10

Sol Frame embellishers

For 1-gang frames wide cover **16100-B**

Packing 25

For 2-gang frames wide covers **16101-B**

Packing 10

For 3-gang frames wide covers **16102-B**

Packing 10

For American-mounting box frames **16350-B**

Packing 20

Frames with integrated metal frame for mounting box Ø 60 mm

		Without claws	With claws	Without claws	
					
		WHITE	WHITE	SILVER GREY	GOLD
	1-gang frame for 1 narrow cover 85x85 mm	16310 Packing 10	16000 Packing 10	16000-PL Packing 5	16000-DR Packing 5
	1-gang frame for 2 narrow covers or 1 wide cover 85x85 mm	16311 Packing 10	16001 Packing 10	16001-PL Packing 5	16001-DR Packing 5
	2-gang frame for 4 narrow covers or 2 wide covers 85x157 mm	16312 Packing 10	16002 Packing 10	16002-PL Packing 5	16002-DR Packing 5
	3-gang frame for 6 narrow covers or 3 wide covers 85x228 mm	16313 Packing 5	16003 Packing 5	16003-PL Packing 5	16003-DR Packing 5





Frames with integrated metal frame for mounting box Ø 60 mm

		WHITE	SILVER GREY	GOLD
	1-gang frame for 1 narrow cover 85x120 mm	16341 Packing 10	16341-PL Packing 5	16341-DR Packing 5
	1-gang frame for 2 narrow covers or 1 wide cover 85x120 mm	16342 Packing 10	16342-PL Packing 5	16342-DR Packing 5

Screwless Frames with integrated metal frame for American mounting box

		WHITE	SILVER GREY	GOLD
	1-gang frame for 1 narrow cover 85x120 mm For 4x2 " box	16351 Packing 10	16351-PL Packing 10	16351-DR Packing 10
	1-gang frame for 2 narrow covers or 1 wide cover 85x120 mm For 4x2 " box	16352 Packing 10	16352-PL Packing 10	16352-DR Packing 10
	1-gang frame for 3 narrow covers or 1 wide and 1 narrow covers 85x120 mm For 4x2 " box	16353 Packing 10	16353-PL Packing 10	16353-DR Packing 10

Surface mounting boxes

	White		White
		<p>Surface mounting box for 1 wide cover or 2 narrow covers</p> <p>Includes a lid in thermosetting material 85 x 85 x 39 mm For 85x85 mm frames without claws of Ref. 16000, 16001, 16310, 16311</p> <p>Packing 5</p>	<p>16460</p>
		<p>Slide nipple cover</p> <p>Packing 10</p>	<p>10152</p>
		<p>Surface mounting box for 2 wide covers or 4 narrow covers</p> <p>Includes two lids in thermosetting material 85x157x39 mm For 85x157 mm frames without claws Ref. 16002, 16312</p> <p>Packing 5</p>	<p>16461</p>
		<p>Surface mounting box for American frames</p> <p>Includes two covers 10152 in thermosetting material 85x120x39 mm For panels, Ref. 16351, 16352 and 16353</p> <p>Packing 5</p>	<p>16360</p>



Rehabitat System

Discover the advantages of renewing an old installation with no refurbishment work needed.

Find out more at:

www.bjc.es/en/series/bjc-rehabitat



Renovating an installation without works

Rehabitat System

The Rehabitat System allows you to quickly and conveniently replace, the most classic mechanisms with the latest models, very reliable and with a more modern design.



Refurbishment of electrical facilities with Estrella series frames or similar

Installed frames

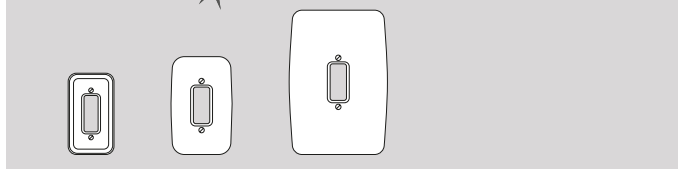

Other installed frames



Flush mounting box 362-1 BJC

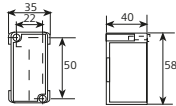

Other flush mounting boxes

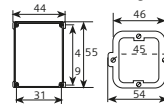

Installed frames

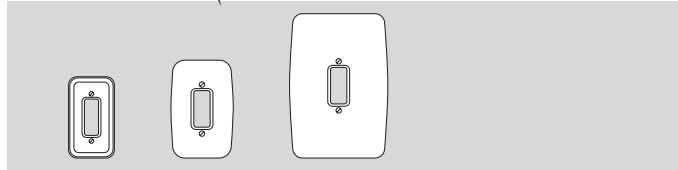

Other installed frames

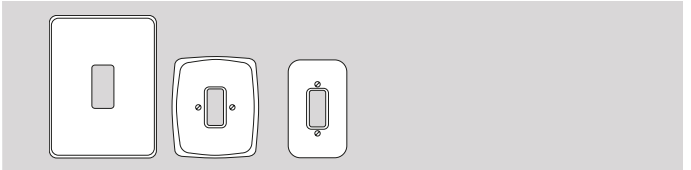

Flush mounting box 362-1 BJC

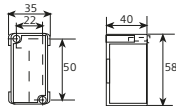

Other flush mounting boxes

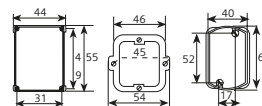

Installed frames

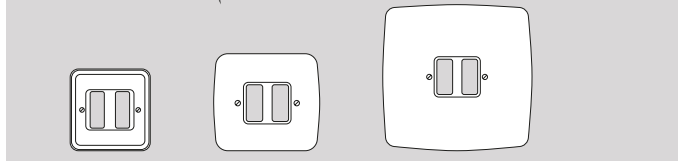

Other installed frames

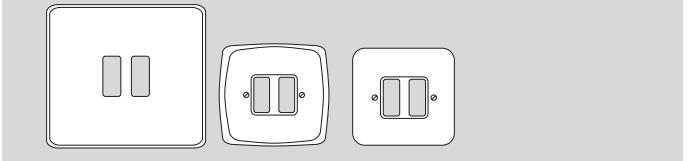

Flush mounting box 362-2 BJC

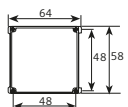

Other flush mounting boxes

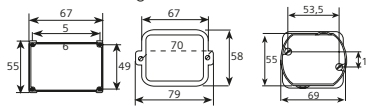

Installed frames

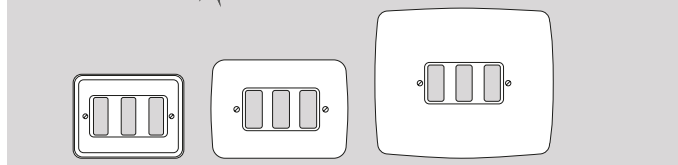

Other installed frames

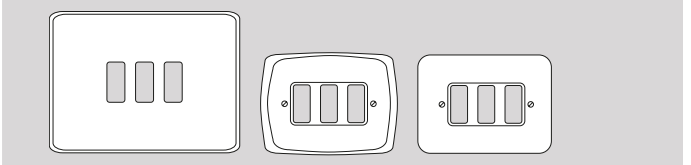

Flush mounting box 362-3 BJC

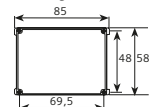

Other flush mounting boxes

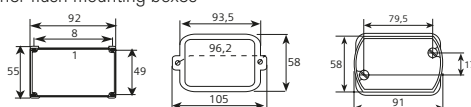

Installed frames

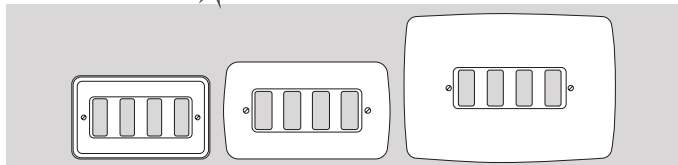

Other installed frames

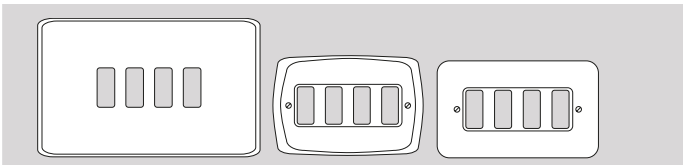

Flush mounting box 362-4 BJC

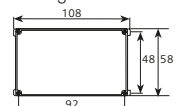

Other flush mounting boxes

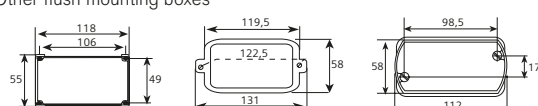

Adapters with frame and integrated metal frame for Estrella series mounting boxes or similar



1 narrow gang frame
96x98 mm
For 362-1 BJC box or similar

Assembly made up of metal frame, adapter and frame

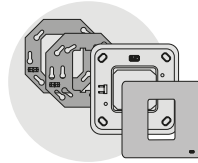

WHITE
16661-B

SILVER
16661-PL
Packing 1

GOLD
16661-DR



1-gang frame for 1 wide cover
Only switches mechanisms, output cables, telephone socket outlets and circuit breakers

96x98 mm
For 362-1 BJC box or similar

Assembly made up of metal frame, adapter and frame

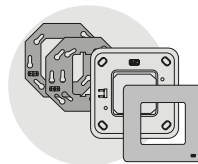

This panel allows you to install a rocker or cover, in a narrow flush mounting box

WHITE
16662-B

SILVER
16662-PL
Packing 1

GOLD
16662-DR



1-gang frame for 1 wide cover or 2 narrow covers

96x98 mm
For 362-2 BJC box or similar

Assembly made up of metal frame, adapter and frame

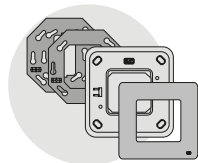

WHITE
16662-B

SILVER
16662-PL
Packing 1

GOLD
16662-DR



1-gang frame for 3 narrow covers or 1 wide and 1 narrow covers

132x98 mm
For 362-3 BJC box or similar

Assembly made up of metal frame, adapter and frame

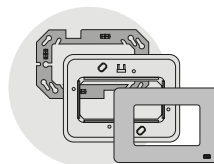

WHITE
16663-B

SILVER
16663-PL
Packing 1

GOLD
16663-DR

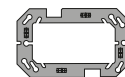

16668 Special Metal frame for each 3-element Compact box



1-gang frame for 4 narrow covers or 2 wide covers

132x98 mm
For 362-4 BJC box or similar

Assembly made up of metal frame, adapter and frame

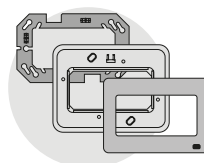

WHITE
16664-B

SILVER
16664-PL
Packing 1

GOLD
16664-DR

Some boxes from other brands, when installed, may require small adjustments to allow the insertion of Sol Teide inserts

Frames for Sol series inserts.

Work-free Refurbishment of electrical facilities with Lineal series frames or similar

Installed frames

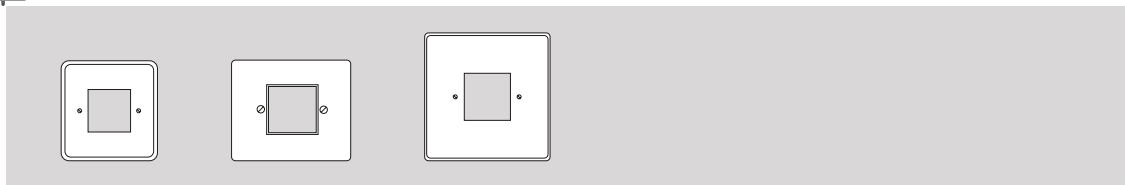

Flush mounting box
906 BJC

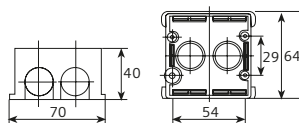

Installed frames

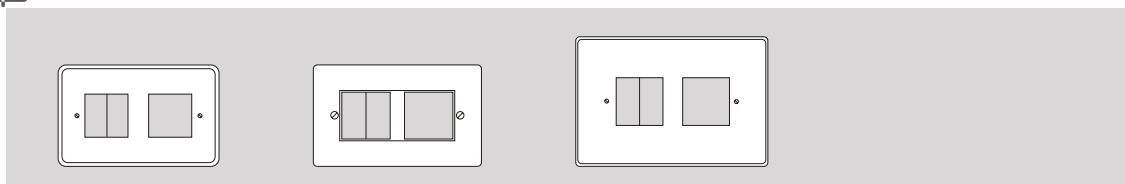

Flush mounting box
907 BJC

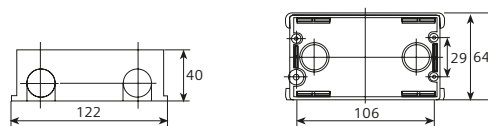

Installed frames

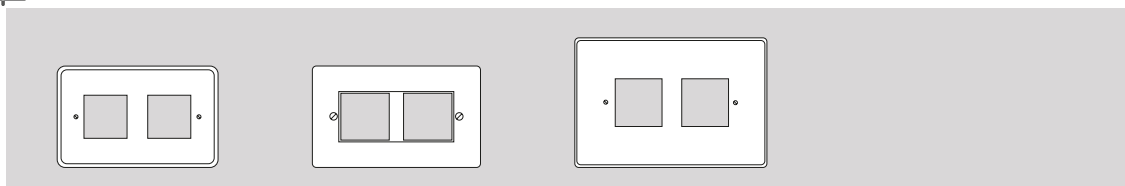

Flush mounting box
907 BJC

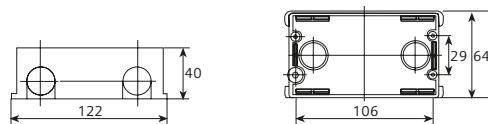

Installed frames

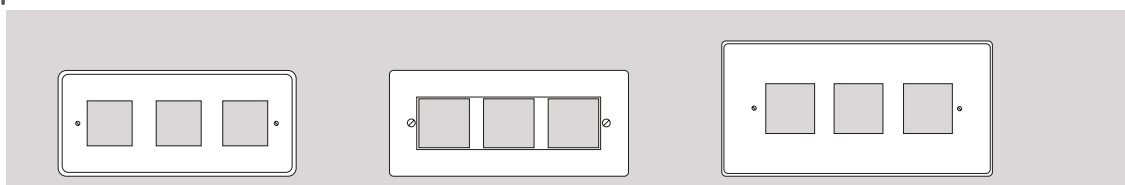

Flush mounting box
908 BJC

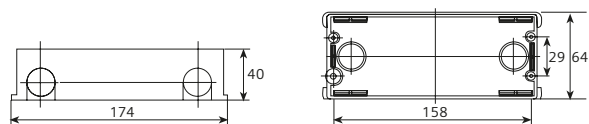

Work-free Refurbishment of electrical facilities with Lineal series frames or similar





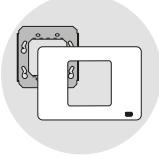

1-gang frame for 2 narrow covers or 1 wide cover

120x85 mm
For 906 BJC box or similar

Assembly made up of frame and metal frame



		
WHITE 16652-B	SILVER 16652-PL Packing 1	GOLD 16652-DR





1-gang frame for 3 narrow covers or 1 wide and 1 narrow covers

120x85 mm
For 907 BJC box or similar

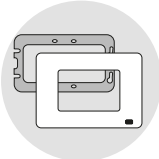
Assembly made up of frame and metal frame



The frame 16653 is intended to replace frames with 3 inserts

		
WHITE 16653-B	SILVER 16653-PL Packing 1	GOLD 16653-DR





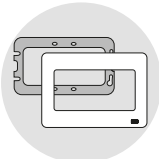

1-gang frame for 4 narrow covers or 2 wide covers

120x85 mm
For 907 BJC box or similar

Assembly made up of frame and metal frame



		
WHITE 16654-B	SILVER 16654-PL Packing 1	GOLD 16654-DR





1-gang frame for 6 narrow covers or 3 wide covers

190x85 mm
For 908 BJC box or similar

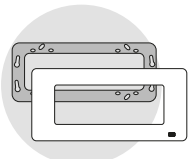
Assembly made up of frame and metal frame



		
WHITE 16656-B	SILVER 16656-PL Packing 1	GOLD 16656-DR

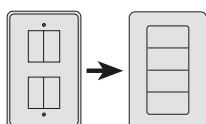

Replacement of vertically installed linear frames requires mounting the inserts in a horizontal position

Frames for Sol inserts series

SIEMENS

Surface mounting





Switches and push-buttons



Two-way switch **5TA4706**
 IP 44 Protection
 10 A, ~ 250 V according to DIN 49200
 Cover size: 75mm x 66mm x 54mm
 Housing made of thermoplastic resistant to strong impacts
 Diameter of mounting holes: 4.5 mm diameter
 Cable entry: from 8 to 13.5 mm Ø - for vertical mounting
 Colour:
 - RAL 7035 (bottom of the housing and rocker)
 - RAL 7042 (housing)

Packing 10



One-way switch with indicator light **5TA4700**
 IP 44 Protection
 10 A, ~ 250 V according to DIN 49200
 Cover size: 75mm x 66mm x 54mm
 Housing made of thermoplastic resistant to strong impacts
 Diameter of mounting holes: 4.5 mm diameter
 Cable entry: from 8 to 13.5 mm Ø - for vertical mounting
 Colour:
 - RAL 7035 (bottom of the housing and rocker)
 - RAL 7042 (housing)

Packing 10



Intermediate switch **5TA4707**
 IP 44 Protection
 10 A, ~ 250 V according to DIN 49200
 Cover size: 75mm x 66mm x 54mm
 Housing made of thermoplastic resistant to strong impacts
 Diameter of mounting holes: 4.5 mm diameter
 Cable entry: from 8 to 13.5 mm Ø - for vertical mounting
 Colour:
 - RAL 7035 (bottom of the housing and rocker)
 - RAL 7042 (housing)

Packing 10



Two-way switch with indicator light, bulb symbol **5TA4716**
 Includes LED lamp 5TG7 333
 IP 44 Protection
 10 A, ~ 250 V according to DIN 49200
 Cover size: 75mm x 66mm x 54mm
 Housing made of thermoplastic resistant to strong impacts
 Diameter of mounting holes: 4.5 mm diameter
 Cable entry: from 8 to 13.5 mm Ø - for vertical mounting
 Colour:
 - RAL 7035 (bottom of the housing and rocker)
 - RAL 7042 (housing)

Packing 10



One-way switch **5TA4701**
 IP 44 Protection
 10 A, ~ 250 V according to DIN 49200
 Cover size: 75mm x 66mm x 54mm
 Housing made of thermoplastic resistant to strong impacts
 Diameter of mounting holes: 4.5 mm diameter
 Cable entry: from 8 to 13.5 mm Ø - for vertical mounting
 Colour:
 - RAL 7035 (bottom of the housing and rocker)
 - RAL 7042 (housing)

Packing 10



Two-way switch with indicator light **5TA4710**
 IP 44 Protection
 10 A, ~ 250 V according to DIN 49200
 Cover size: 75mm x 66mm x 54mm
 Housing made of thermoplastic resistant to strong impacts
 Diameter of mounting holes: 4.5 mm diameter
 Cable entry: from 8 to 13.5 mm Ø - for vertical mounting
 Colour:
 - RAL 7035 (bottom of the housing and rocker)
 - RAL 7042 (housing)

Packing 10

Switches and push-buttons



Two-way switch with bulb symbol and labelling field **5TA4726**

Includes LED lamp 5TG7 333
 IP 44 Protection
 10 A, ~ 250 V according to DIN 49200
 Cover size: 75mm x 66mm x 54mm
 Housing made of thermoplastic resistant to strong impacts
 Diameter of mounting holes: 4.5 mm diameter
 Cable entry: from 8 to 13.5 mm Ø - for vertical mounting
 Colour:
 - RAL 7035 (bottom of the housing and rocker)
 - RAL 7042 (housing)
 Includes LED lamp 5TG7 333

Packing 10



Double one-way switch **5TA4705**

IP 44 Protection
 10 A, ~ 250 V according to DIN 49200
 Cover size: 75mm x 66mm x 54mm
 Housing made of thermoplastic resistant to strong impacts
 Diameter of mounting holes: 4.5 mm diameter
 Cable entry: from 8 to 13.5 mm Ø - for vertical mounting
 Colour:
 - RAL 7035 (bottom of the housing and rocker)
 - RAL 7042 (housing)

Packing 10



2 pole one-way switch with I/O symbols **5TA4702**

IP 44 Protection
 10 A, ~ 250 V according to DIN 49200
 Cover size: 75mm x 66mm x 54mm
 Housing made of thermoplastic resistant to strong impacts
 Diameter of mounting holes: 4.5 mm diameter
 Cable entry: from 8 to 13.5 mm Ø - for vertical mounting
 Colour:
 - RAL 7035 (bottom of the housing and rocker)
 - RAL 7042 (housing)

Packing 10



Double two-way switch **5TA4708**

IP 44 Protection
 10 A, ~ 250 V according to DIN 49200
 Cover size: 75mm x 66mm x 54mm
 Housing made of thermoplastic resistant to strong impacts
 Diameter of mounting holes: 4.5 mm diameter
 Cable entry: from 8 to 13.5 mm Ø - for vertical mounting
 Colour:
 - RAL 7035 (bottom of the housing and rocker)
 - RAL 7042 (housing)

Packing 10



Three-pole one-way switch with I/O symbols **5TA4753**

16A ~ 400V
 IP 44 Protection
 10 A, ~ 250 V according to DIN 49200
 Cover size: 75mm x 66mm x 54mm
 Housing made of thermoplastic resistant to strong impacts
 Diameter of mounting holes: 4.5 mm diameter
 Cable entry: from 8 to 13.5 mm Ø - for vertical mounting
 Colour:
 - RAL 7035 (bottom of the housing and rocker)
 - RAL 7042 (housing)

Packing 10



Push-button with white panel and set of symbols (lamp, bell and key symbols) **5TD4701**

Lamp not included

Push-button with indicator light and bulb symbol **5TD4705**

Includes LED lamp 5TG7 333

IP 44 Protection
 10 A, ~ 250 V according to DIN 49200
 Cover size: 75mm x 66mm x 54mm
 Housing made of thermoplastic resistant to strong impacts
 Diameter of mounting holes: 4.5 mm diameter
 Cable entry: from 8 to 13.5 mm Ø - for vertical mounting
 Colour:
 - RAL 7035 (bottom of the housing and rocker)
 - RAL 7042 (housing)

Packing 10

Switches and push-buttons



Push-button with indicator light **5TD4706**

Includes indicator LED light 5TG7 333
 IP 44 Protection
 10 A, ~ 250 V according to DIN 49200
 Cover size: 75mm x 66mm x 54mm
 Housing made of thermoplastic resistant to strong impacts
 Diameter of mounting holes: 4.5 mm diameter
 Cable entry: from 8 to 13.5 mm Ø - for vertical mounting
 Colour:
 - RAL 7035 (bottom of the housing and rocker)
 - RAL 7042 (housing)
 Includes indicator LED light 5TG7 333

Packing 10



Indicator LED light **5TD4780**

With lamp ~ 250 V
 75 mm x 66 mm x 54 mm
 IP 44 Protection
 10 A, ~ 250 V according to DIN 49200
 Cover size: 75mm x 66mm x 54mm
 Housing made of thermoplastic resistant to strong impacts
 Diameter of mounting holes: 4.5 mm diameter
 Cable entry: from 8 to 13.5 mm Ø - for vertical mounting
 Colour:
 - RAL 7035 (bottom of the housing and rocker)
 - RAL 7042 (housing)

Packing 10

Socket outlets (screw-less terminals)



Schuko® socket outlet with increased touch protection and hinged lid IP44 **5UB4717**

Dimensions: 75mm x 66mm x 54mm

Packing 10



Schuko® socket outlet with increased touch protection, hinged lid and labelling field IP44 **5UB4718**

Dimensions: 75mm x 66mm x 54mm

Packing 10

Socket outlets



Double vertical Schuko® socket outlet with increased touch protection and hinged lid IP44 **5UB4724**

Dimensions: 151 mm x 66mm x 54mm
 Labelling field: on request

Packing 5



3-fold horizontal Schuko® socket outlet with increased touch protection and hinged lid IP44 **5UB4732**

Dimensions: 75mm x 201mm x 54mm
 Labelling field: on request

Packing 1



Double horizontal Schuko® socket outlet with increased touch protection and hinged lid IP44 **5UB4725**

Dimensions: 75mm x 134mm x 54mm
 Labelling field: on request

Packing 5



Schuko® socket outlet with increased touch protection and hinged locked lid IP44 **5UB4705**

Dimensions: 75mm x 66mm x 66mm
 With two identical keys

Packing 1

Combinations of switches/push-buttons and socket outlets



Two-way switch and Schuko® socket outlet with increased touch protection and hinged lid IP44 **5TA4826**

IP 44 Protection
 16 A, ~ 250 V ; 10 A, ~ 250 V according to DIN 49440
 Housing made of thermoplastic resistant to strong impacts
 Diameter of mounting holes: 4.5 mm diameter
 Cable entry: from 8 to 13.5 mm Ø - for vertical mounting
 Colour:
 - RAL 7035 (bottom of the housing and rocker)
 - RAL 7042 (housing)
 Dimensions: 66 mm x 151 mm

Packing 5



Push-button and Schuko® socket outlet with increased touch protection and hinged lid IP44 **5TD4821**

IP 44 Protection
 16 A, ~ 250 V ; 10 A, ~ 250 V according to DIN 49440
 Housing made of thermoplastic resistant to strong impacts
 Diameter of mounting holes: 4.5 mm diameter
 Cable entry: from 8 to 13.5 mm Ø - for vertical mounting
 Colour:
 - RAL 7035 (bottom of the housing and rocker)
 - RAL 7042 (housing)
 Dimensions: 66 mm x 151 mm

Packing 1



Double one-way switch and Schuko® socket outlet with increased touch protection and hinged lid IP44 **5TA4825**

IP 44 Protection
 16 A, ~ 250 V ; 10 A, ~ 250 V according to DIN 49440
 Housing made of thermoplastic resistant to strong impacts
 Diameter of mounting holes: 4.5 mm diameter
 Cable entry: from 8 to 13.5 mm Ø - for vertical mounting
 Colour:
 - RAL 7035 (bottom of the housing and rocker)
 - RAL 7042 (housing)
 Dimensions: 66 mm x 151 mm

Packing 1

Blinds control



One-way switch with key for blinds **5TA7650**
Momentary/maintained contact in both directions
With 2 keys
Hinged lid with key symbol
IP44

One-way switch with key for blinds **5TA7651**
Sensing position on both sides
With 2 keys
Hinged lid with key symbol
IP44

IP 44 Protection – 10 A, ~ 250 V according to DIN 49 200
 Housing made of thermoplastic resistant to strong impacts
 Diameter of mounting holes: 4.5 mm diameter
 Cable entry: from 8 to 13.5 mm Ø - for vertical mounting
 Dimensions 75mm x 66mm x 54mm – attached via screws, lid included

Packing 1



Push-button with electrical interlocking device for blinds with up/down symbols **5TD4708**
IP44

Quick connection - terminals similar to 5TA2 114
 IP 44 Protection – 10 A, ~ 250 V according to DIN 49 200
 Housing made of thermoplastic resistant to strong impacts
 Diameter of mounting holes: 4.5 mm diameter
 Cable entry: from 8 to 13.5 mm Ø - for vertical mounting
 Dimensions 75mm x 66mm x 54mm – attached via screws, lid included

Packing 10

Accessories



Cable entry slide nipple with hole for coupling simple devices **5TG4205**
for coupling simple devices

Packing 10



Slide nipple without hole **5TG4204**

Packing 10



Channel entry **5TG4212**
for 15 mm x 15 mm and 17 mm x 17 mm components

Packing 10



Neon Lamp, isolated 230 V

Light intensity	Consumption	Stand colour	
weak	0,18 mA	white	5TG7321

Packing 10



Indicator LED light for switches and push-buttons

For rockers with lens

Colour	Voltage	Consumption	
Red	1,5 VDC	2	5TG7318
	8 VAC	2	5TG7315
	12 VAC	2	5TG7316
	24 VAC	2	5TG7317
	230 VAC	1	5TG7353
Orange	230 VAC	0,9	5TG7333
		1,0	5TG7343
White	230 VAC	1,1	5TG7354
Blue	230 VAC	1,1	5TG7355

Cannot be used with rockers that already have a coloured lens.

Using indicator LED lights together with CFL (energy saving) lamps or transformer lamps can cause LEDs to flicker significantly.

Packing 10



Spare part lens for switches and push-buttons

- red **5TG4206**
- green **5TG4208**
- white **5TG4207**
- yellow **5TG4210**

Packing 10



Spare part lamp for indicator light, 250V **5TG7301**

Packing 10



Set of lens for indicator lights for switches and push-buttons **5TG4200**

2 x red, 2 x clear, 2 x white

Packing 10

SIEMENS

Standalone detectors





Motion detectors



Ceiling detector, 360° range for flush-mounting **2391**

- Power supply voltage: 230Vac 50Hz.
- Consumption <1W.
- Contact Capacity: 16A cos φ =1
- Incandescent or halogen 230V: 3,000W
- Halogen lamps with electronic transformer: 3,000W
- Halogen lamps with ferromagnetic transformer: 2,400W
- Fluorescence: 1.300W (130 μ F)
- Fluo-compact: 18x7W, 12x11W, 10x15W, 10x20W, 10x23W.
- Angle of detection: Circular 360°.

Packing 1



Ceiling detector, 360° range for surface mounting **2390**

- Power supply voltage: 230Vac 50Hz.
- Consumption <1W.
- Contact Capacity: 16A cos φ =1
- Incandescent or halogen 230V: 3,000W
- Halogen lamps with electronic transformer: 3,000W
- Halogen lamps with ferromagnetic transformer: 2,400W
- Fluorescence: 1.300W (130 μ F)
- Fluo-compact: 18x7W, 12x11W, 10x15W, 10x20W, 10x23W.
- Angle of detection: Circular 360°.

Packing 1

Carbon monoxide detectors



CO (carbon monoxide) detector **5TC1260-4**

- LCD display
- 10 years battery life
- Non-replaceable lithium battery (included)
- EN 50291-1:2018
- EN 50270-2015/AC:2016
- VDS certified
- Dimensions \varnothing 105 x 35

Packing 1

Smoke detectors



SD230N smoke detector **5TC1296**

- Titan white (similar to RAL 9010)

Technical information:

Supply	230 V AC and backup 9 V battery (included in delivery)
Network	Up to 38 detectors of the same type
Signalling	Acoustic signal: Horn > 85 dB(A) Red LED optical indicator
Temperature	0 ... +50 °C
Dimensions (diameter x height)	110 mm x 60 mm
Mounting	Surface with or without box Surface mounting
Protection degree	IP30
Certification	Certification EN 14604 10/05

Packing 1



Smoke detector **5TC1292-8**

- 10 years battery life
- Non-replaceable lithium battery (included)
- EN14604:2005+AC:2008
- Suitable for motorhomes and caravans
- VDS certified
- Dimensions Ø 105 x 35 mm

Packing 1



Surface mounting connection box for "SD230N smoke detectors" **5TC1297**

- Surface mounting box for smoke detector SD230N
- Dimensions: 93 mm x 27 mm
- Box required if there is no box for holding the 230 V connector
- Titan white (similar to RAL 9010)

Packing 1

BJC

Assorted material



Flush-mounting boxes



Flush-mounting box **2373-1**
Thermoplastic material
Dimensions: 71x71x43 mm

Packing 640

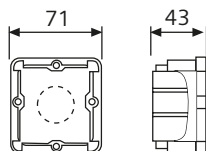

For recessing into solid non-combustible walls and ceilings after construction
Temperature during installation -5 °C +60 °C



Protective cover **2374-1**
Allows you to locate the box after plastering

Packing 1000



Flush-mounting box **2341**
1 element for plasterboard wall

Packing 120



Flush-mounting box **2342**
2 elements for plasterboard wall

Packing 60



Flush-mounting box **2343**
3 elements for plasterboard wall

Packing 35



Flush-mounting box **2344**
4 elements for plasterboard wall

Packing 30



Flush-mounting box **2345**
5 elements for plasterboard wall

Packing 21



Hole saw hardened **2158000**
teeth shank for plasterboard wall
diam. 68 mm
prof. 40 mm

Packing 1



Deburrer for Plasterboard Ø 68 mm **5892000** **NEW**
Tool for flush installation of hollow wall boxes

Packing 1



Replacement blades **5893000** **NEW**
for ref. 5892000

Packing 1

Viva and Coral surface box

PC-ASA. Resistant to UV rays and halogen free.

Fire-resistant. GWT 650°C.

RoHS.

Channel inlets 22x10, 16x10, 12x7 mm and

Tubes of diameters 25, 20 and 16 mm.

Dimensions of boxes once assembled:

1 part: 86x86x43 mm

2 parts: 157x86x43 mm

3 parts: 228x86x43 mm

4 parts: 299x86x43 mm

Packing 1

Modular surface box



POLAR WHITE
23460

MOON SILVER
23460-PL

LAVA GREY
23460-GL

Modular extension unit



23461

23461-PL

23461-GL

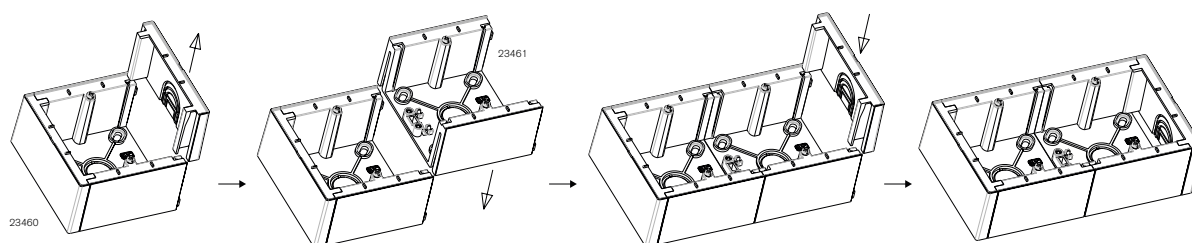

Bells & Buzzers



Interference suppression bell

Alternating Ø 60 mm only
230 V~
Intermittent Use
Packing 1

White
614



Surface buzzer

Interference suppression
Only alternates AC 230 V
Adjustable
Intermittent Use
Packing 10

White
610-B

25A Socket outlets & Plugs



2P+E socket outlet

25 A 250 V~
85x85x35 mm
Accepts any 25 A 250 A 2P+E plug~/ MDS 20315
The terminals hold cables of up to 10 mm² sections.
The box recommended for this socket outlet is Ref. 2373-I
Packing 5

White
2225



2P+E plug

25 A 250 V~
Packing 10

White
2224-B

SIEMENS

KNX

Technology for smart buildings and homes

Smart and automated home, office and hotel management offers increased levels of comfort, profitability and safety. The Siemens KNX system has been designed to easily perform and automate a series of tasks, for example, centralised building control, lighting scenarios, presence simulations and global or individual climate control. The system can be controlled in such a way that it caters to the needs of each specific case and it can be programmed at any time. On-going processes, such as blind or garden irrigation control, can be adapted automatically to the desired times or according to specific weather conditions.





Smart tailored solutions

Siemens' experience, the best warranty for you.

Siemens' smart building technology is the result of over 60 years of research and development and more than 30 years of experience in building automation across the world.

Our extensive experience allows us to offer efficient and long-lasting products, which are compatible with previous versions, protecting your investment in building automation and leaving room for future expansion needs in the long-term.

Reduced consumption, environmental investment.

Siemens' products and Systems achieve up to 50% more energy savings and comply with the strictest energy certifications, such as energy category A of the EN 15232 standard.

Outstanding simplicity.

Our products are easy to install and use, throughout all project phases. They can be easily installed within the shortest possible time and can be quickly configured so they are ready to operate in no time. Intuitive handling eliminates user error in everyday situations. Likewise, our products are easy to maintain, to guarantee their efficiency.





Technology for smart buildings and homes

Power supplies



Power supply
N125/02 160 mA (4 modules) 5WG1125-1AB02
Type: N 125/02



Power supply
N125/12 320 mA (4 modules) 5WG1125-1AB12
Type: N 125/12



Power supply
N125/22 640 mA (4 modules) 5WG1125-1AB22
Type: N 125/22



Distributed power supply 80mA, 5WG1125-4AB23
Type: RL 125/23
RL type for AP 641 modular assembly boxes or
AP118 individual modular assembly box



Distributed power supply
80mA 5WG1125-4CB23
Type: JB 125C23
Indoor mounting or attached to UL/NEMA Type
connection boxes using a 1/2" threaded connector.
120 VAC 50..60 Hz power supply voltage.

Line/backbone coupler



GAMMA instabus Line/backbone
coupler N 140/13 (2 modules) 5WG1140-1AB13
Type: N 140/13
Allows data to be exchanged between 2 EIB lines
and the connection of overhead lines and the main or
backbone interconnection line between EIB areas.

Communication interface



Communication interface **5WG1148-1AB12**
Type: N 148/12
Communication: USB 2.0 and USB 3.0 compatible.
Type: N / Modules: 1
Power supply: Bus



Communication interface **5WG1143-1AB01**
Type: N 143
Communication: KNX / ETHERNET / BACNET IP (Server)
Type: N / Modules: 4
Power supply: Bus and 24V DC
Tunnelling links: 1



Communication interface **5WG1148-1AB23**
Type: N 148/23
Communication: Ethernet
Type: N / Modules: N/1
Power supply: Bus and 24V DC
Tunnelling links: 4
KNX Secure: Yes
SD Slot: Yes

Communication interface **5WG1152-1AB01**
Type: N 152
Communication: ETHERNET
Type: N / Modules: 4
Power supply: Bus and 24V DC
Tunnelling links: 1
Time Func. Clock, Scenario Log.: Yes
Web Server: Yes

Communication interface **5WG1146-1AB03**
Type: N 146/03
Communication: Ethernet
Type: N / Modules: N/1
Power supply: Bus and 24V DC
Line coupler func.: Yes
Tunnelling links: 4
KNX Secure: Yes
SD Slot: Yes

Technology for smart buildings and homes

SIEMENS miro pushbuttons



Pushbutton UP 221

5WG1221-2DB33

Type: UP 221/33

1- fold, with status LED, aluminium metallic



Pushbutton UP 222

5WG1222-2DB33

Type: UP 222/33

2- fold, with status LED, aluminium metallic



Pushbutton 223

5WG1223-2DB33

Type: UP 223/33

Triple, neutral, aluminium metallic with Status LED.

Pushbutton UP 223

5WG1223-2AB34

Type: UP 223/34

Triple, neutral, aluminium metallic with Status LED and temperature sensor.

Pushbutton UP 223

5WG1223-2DB35

Type: UP 223/35

Triple, neutral, aluminium metallic with Status LED and IR receiver/decoder.

SIEMENS style pushbuttons



Pushbutton UP 285

5WG1285-2DB43

Type: UP 285/43

1-fold, with status LED, platin metallic



Pushbutton UP 286

5WG1286-2DB43

Type: UP 286/43

2-fold, with status LED, platin metallic



Pushbutton UP 287

5WG1287-2DB43

Type: UP 287/43

4-fold, with status LED, platin metallic

Pushbutton 287

5WG1287-2AB44

Type: UP 287/44

4-fold, platinum metallic reference with Status LED and temperature sensor.

Pushbutton 287

5WG1287-2DB45

Type: UP 287/45

4-fold, platinum metallic reference with Status LED and IR receiver/decoder.

Bus coupling units for KNX push-buttons (for the TSG, i-system and style)



Bus coupling 5WG1117-2AB12

Type: UP 117/12
UP 117 bus coupler for KNX push-buttons.

I/O Button Interface



I/O Button Interface UP 220/21 5WG1220-2AB21

Type: UP 220/21
Connects up to 2 conventional one-way switches or push-buttons with potential-free contacts, up to a maximum distance of 10 metres.



I/O Button Interface UP 220D31 5WG1220-2DB31

Type: UP 220/31
Connects up to 4 conventional one-way switches or push-buttons with potential-free contacts, up to a maximum distance of 10 metres.

Technology for smart buildings and homes

Communication interface



Communication interface **5WG1152-1AB01**

Type: N152
Communication: Ethernet
Type: N / Modules: 4
Power supply: Bus and 24V DC
Tunnelling links: 1

Temperature sensors



Temperature sensor **S55624-H104**

Type: QMX3.P40
Sensor: T/RH
Temperature PID control: Yes
Threshold value for RH and CO₂: Yes
Colour: Titan white

Type: QMX3.P70
Sensor: T/RH/ CO₂
Temperature PID control: Yes
Threshold value for RH and CO₂: Yes
Colour: Titan white
Display with HVAC push-buttons (presence, operating mode and fan)

Visualisation



Room operating device

UP 227 **5WG1227-2AB11**

Type: UP 227/11
KNX control display,
with 96 x 128 pixel screen and LCD display.

Mounting plate

Type: UP 227/81 **S55720-S161**

Mounting frame of the UP227 unit.

Touch

Technical data

TFT - Colour 320 x 640 pixels, 1/4 VGA. Resolution: 263k (R,G,B - 6 Bit). Size 5.7". Brightness: 280 cd/m².

110 KNX functions (50 standard functions and 60 additional functions).

Programming events with a weekly schedule for objects with standard/advanced functions.

Presence simulation for all communication objects registered in the weekly schedule.

Scenario control for objects with standard/advanced functions.

Logic functions for objects with advanced functions. Display of alarms, with up to 16 alarm reports.

Individual protection of the page with a password. Integrated clock, displaying the date and time.

Weight: 420 g. Dimensions: (H x W x D) 161.5 X 135 64 mm.

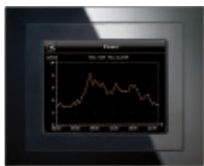

Touch panel

5WG1588-2AB13

Type: UP 588/13
Colour 5,7" UP588/13 230V AC



Touch panel

5WG1588-2AB23

Type: UP 588/23
Colour 5,7" UP588/23 24V ACDC



Touch screen

5WG1205-2AB22

Type: UP 205/22
Ambient control unit TC5, black,
with 5" capacitive touchscreen.
Colour IPS with a resolution of
480x854 pixels.
Vertical and horizontal mounting



Touch screen

5WG1205-2AB12

Type: UP 205/12
Ambient control unit TC5, colour
white, with 5" capacitive touch screen.
Colour IPS with a resolution of
480x854 pixels.
Vertical and horizontal mounting.

Touch panels accessories



Frame

5WG1588-8AB12

Type: 588/12
Design frame for UP 588/13 or UP 588/23 touch
screens, anodized aluminum.

Frame

5WG1588-8AB13

Type: 588/13
Design frame for UP 588/13 or UP 588/23 touch
screens, stainless steel.

Frame

5WG1588-8AB14

Type: 588/14
Design frame for UP 588/13 or UP 588/23 touch
screens, black crystal.

Frame

5WG1588-8AB15

Type: 588/15
Design frame for UP 588/13 or UP 588/23 touch
screens, white crystal.



Touch Panel UP socket

5WG1588-8EB01

Type: 588/01
To be installed on UP 588/13 or
UP 588/23 touch screens

Technology for smart buildings and homes

Closed-loop lighting control device, ceiling mounted



Brightness control **5WG1258-2DB12**
 Type: UP 258D12
 Two-point control
 Lux sensor (transmits to the bus)
 Detection angle: 360°
 Detection range (m): 5.5 x 5.5
 Presence detection
 Recommended height: 2.5
 Colour: White

Brightness control **5WG1258-2EB22**
 Type: UP 258E22
 Constant Light Control
 Lux sensor (transmits to the bus)
 Detection angle: 360°
 Detection range (m): 5.5 x 5.5
 Presence detection
 Recommended height: 2.5
 Colour: White

Brightness control **5WG1255-2DB21**
 Type: UP 255D21
 Constant Light Control
 Two-point control
 Lux sensor (transmits to the bus)
 Recommended height: 2.5
 Colour: White



WIDE multi presence detector with temperature measurement **5WG1258-2DB31**
 Type: UP 258D31
 Constant Light Control
 Two-point control
 Lux sensor (transmits to bus)
 Detection angle: 360° Detection range (m2): 400
 Detection range (m2): 400
 Recommended height: 3
 Colour: White

WIDE presence detector multi with temperature and humidity measurement **5WG1258-2DB41**
 Type: UP 258D41
 Constant Light Control
 Two-point control
 Lux sensor (transmits to bus)
 Detection angle: 360° Detection range (m2): 400
 Detection range (m2): 400
 Recommended height: 3
 Colour: White

WIDE presence detector multi with measurement of temperature, humidity and CO₂ **5WG1258-2DB51**
 Type: UP 258D51
 Constant Light Control
 Two-point control
 Lux sensor (transmits to bus)
 Detection angle: 360°
 Detection range (m2): 400
 Detection range (m2): 400
 Recommended height: 3
 Colour: White

UP258 Motion detector accessories and UP255 lux sensors



IR Remote control **5WG1255-7AB11**
 Type: S 255/11
 For "Brightness controller sensor"



Surface mounted box **5WG1258-7EB01**
 Type: AP 258E01
 For UP 255D21 sensors

Open-loop lighting control devices

	Device Type: AP 254/02 Lux Temperature Facades: 4	5WG1254-3EY02		Device Type: AP 257/51 Lux Wind Dawn Temperature Weather station Facades: 3	5WG1257-3AB51
	Device Type: AP 257/61 Lux Wind Rain Dawn Temperature Solar tracking Weather station Facades: 8 24 VDC Auxiliary power supply	5WG1257-3AB61		Device Type: AP 257/22 GPS Lux Wind Rain Dawn Temperature Solar tracking Facades: 8 24 VDC Auxiliary power supply	5WG1257-3AB22

IR

	Portable infrared emitter Type: S 425/72 8 channels, S 425	5WG1425-7AB72		Infrared receiver, S 450 Type: S 450/03 Receives the signals emitted by wall-mounted portable emitters, amplifies them and forwards them in the form of electrical signals to the KNX actuators.	5WG1450-7AB03
---	---	----------------------	--	---	----------------------

Binary inputs



N26 _ / _ 1

RL 260/23

JB 260C23

	Type	N° Inputs	Features		Programming					Reference
			Input voltage	Modules	Power supply	Max. cable dist. (m)	Max. groups Addr.	Max Assignments	Trans. in bus recov.	
DIN RAIL MOUNTING	N 262E01	8	voltage-free	6	230V AC	100	97	97	•	5WG1262-1EB01
	N 262E11	16	voltage-free	6	230V AC	100	97	97	•	5WG1262-1EB11
	N 263E01	8	12..230V AC/DC	6	230V AC	100	97	97	•	5WG1263-1EB01
	N 263E11	16	12..230V AC/DC	6	230V AC	100	97	97	•	5WG1263-1EB11
	N 264E11	16	(8 voltage-free) (8 12..230V AC/DC)	6	230V AC	100	97	97	•	5WG1264-1EB11
CONTROL BOX	RL 260/23	4	12..230V AC/DC	Control Box	Bus	100	120	120	•	5WG1260-4AB23
NEMA UL	JB 260C23	4	12..230V AC/DC	UL/NEMA Box	Bus	100	120	120	•	5WG1260-4CB23

Tecnología para edificios y viviendas inteligentes

Mixed actuators



N501/01 N502/02 UP 511S32 UP 562S32 UP 525S32

		Features					Programming				
	Type	N° Outputs	N° Inputs	Output Amperage (A)	Modules	Manual action	Power supply	Cons. Bus (mA)	Logic functions	Bus fail. config. beh.	Reference
RAIL MOUNTING	N 501/01	4 for blinds	8 voltage inputs	6	8	electronics	230V AC	5	•	•	5WG1501-1AB01
	N 502/02	8	8 voltage inputs	16	N/8	electronics	230V AC	5	•	•	5WG1502-1AB02
FLUSH-MOUNTED	UP 511S32	1	3 binary inputs	16	UP	no man. action	Bus	18	•	•	5WG1511-2SB32
	UP 562S32	2 binarias o 1 persiana	3 binary inputs	Σ16	UP	no man. action	Bus	18	•	•	5WG1562-2SB32
	UP 525S32	1 para dimmer	3 binary inputs	200 WLED / 230 W conv.	UP	no man. action	Bus	18	•	•	5WG1525-2SB32

Room BOX boxes

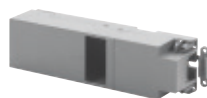

Mounting box
Type: AP 118/01
AP118 individual modular mounting box for RS/RL modules.

5WG1118-4AB01

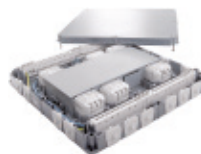

Mounting box
Type: AP 641
Modular mounting box for 8 AP641 modules and for RS/RL modules.

5WG1641-3AB01

Binary outputs



N530D31 N534D51 N534D61

		Features					Programming					
	Type	No. Outputs	Type / Modules	Amperage (A)	Load Types	Manual Action	Power supply	Logic functions	Max. Group Addr.	Max. Assignments	Bus fail. config. beh.	Reference
DIN RAIL MOUNTING	N 530D31	4	N/4	6	AX	mechanical	230V AC	•	2.000	2.000	•	5WG1530-1DB31
	N 530D51	8	N/8	6	AX	mechanical	230V AC	•	2.000	2.000	•	5WG1530-1DB51
	N 530D61	12	N/12	6	AX	mechanical	230V AC	•	2.000	2.000	•	5WG1530-1DB61
	N 532D31	4	N/4	10	AX	mechanical	230V AC	•	2.000	2.000	•	5WG1532-1DB31
	N 532D51	8	N/8	10	AX	mechanical	230V AC	•	2.000	2.000	•	5WG1532-1DB51
	N 532D61	12	N/12	10	AX	mechanical	230V AC	•	2.000	2.000	•	5WG1532-1DB61
	N 534D31	4	N/4	16	AX	mechanical	230V AC	•	2.000	2.000	•	5WG1534-1DB31
	N 534D51	8	N/8	16	AX	mechanical	230V AC	•	2.000	2.000	•	5WG1534-1DB51
	N 534D61	12	N/12	16	AX	mechanical	230V AC	•	2.000	2.000	•	5WG1534-1DB61

Binary outputs



UP511/10

RL512/23

N567/_

N512C01

N 562/11 y /21

JB 513C23

		Features				Programming							
	Type	No. Outputs	Type / Modules	Amperage (A)	Load Types	Manual Action	Power supply	Ct. Meas.	Logic functions	Max. Group Addr.	Max Assignments	Config. beh.	Reference
DIN RAIL MOUNTING	N 567/22	16	N/8	10	R	electronics	230V AC		•	106	106		5WG1567-1AB22
	N 512C01	8	N/8	16	C	mechanical	Bus	UL	•	52	52	•	5WG1512-1CB01
	N 562/11 ⁽¹⁾	3	N/3	10	AX	electronics	Bus	•	•	511	511	•	5WG1562-1AB11
	N 562/21 ⁽²⁾	3	N/3	10	AX	electronics	Bus	•	•	511	511	•	5WG1562-1AB21
	N 512/11 ⁽¹⁾	3	N/3	16	AX	electronics	Bus	•	•	511	511	•	5WG1512-1AB11
	N 512/21 ⁽²⁾	3	N/3	16	AX	electronics	Bus	•	•	511	511	•	5WG1512-1AB21
	N 513/11 ⁽¹⁾	3	N/3	20	AX	electronics	Bus	•	•	511	511	•	5WG1513-1AB11
	N 513/21 ⁽²⁾	3	N/3	20	AX	electronics	Bus	•	•	511	511	•	5WG1513-1AB21
FLUSH-	UP 510/03	2	UP for push-button	10	R	no man. action	Bus		•	120	120	•	5WG1510-2AB03
	UP510/13	2	UP	10	R	no man. action	Bus		•	120	120	•	5WG1510-2AB13
CONTROL BOX	RS 510/23	2	RS	10	R	no man. action	Bus		•	120	120	•	5WG1510-2AB23
	RL 512/23	1	RL	16	AX	no man. action	Bus		•	120	120	•	5WG1512-4AB23
	RL 513/23	3	RL	6	R	no man. action	Bus		•	120	120	•	5WG1513-4DB23
UL/ NEMA Box	JB 510C23	2	JB	10	R	no man. action	Bus	UL	•	120	120	•	5WG1510-4CB23
	JB 512C23	1	JB	20	AX	no man. action	Bus	UL	•	120	120	•	5WG1512-4CB23
	JB 513C23	3	JB	6	R	no man. action	Bus	UL	•	120	120	•	5WG1513-4CB23

⁽¹⁾ Master module
⁽²⁾ Slave module

NOTE: each master module can be combined with up to 4 slave modules of any Type.

Binary current detection outputs



N535D31

N535D51

N535D61

		Features			Programming						
Type	No. Outputs	Type / Modules	Amperage (A)	Load Types	Ct. detec.	Manual Action	Power supply	Logic functions	Bus fail. config. beh.	Reference	
N 535D31	4	N/4	16	AX	•	mechanical	230V AC	•	•	5WG1535-1DB31	
N 535D51	8	N/8	16	AX	•	mechanical	230V AC	•	•	5WG1535-1DB51	
N 535D61	12	N/12	16	AX	•	mechanical	230V AC	•	•	5WG1535-1DB61	

Technology for smart buildings and homes

Incandescent lamp dimmers



RS525/23 UP525/13 UP525/03 JB525C23 5WG1528-1DB01

	Features			Programming						Reference
	Type	Power	Type / Modules	Power supply	Max. leng.	Compatible with LED loads	Scenarios	Max. Group Addr.	Max. Assign.	
DIN RAIL MOUNTING	N 528D01	1 x 500VA 2 x 300VA	N/4	Bus	100	•	•	127	127	5WG1528-1DB01
	N 554D31	1 x 1.000VA 4 x 300VA	N/8	Bus	100	•	•	240	240	5WG1554-1DB31
FLUSH-MOUNTED	UP 525/03	10 ... 250VA	UP for push-button	Bus			•	120	120	5WG1525-2AB03
	UP 525/13	10 ... 250VA	UP	Bus			•	120	120	5WG1525-2AB13
	UP 525/31	50 ... 210VA	UP	Bus		x2 binary inp.	•	26	27	5WG1525-2AB31
CONTROL BOX	UP 525/23	10 ... 250VA	RS	Bus			•	120	120	5WG1525-2AB23
UL/ NEMA Box	JB 525C23	10 ... 250VA	JB	Bus			•	120	120	5WG1525-4CB23

⁽¹⁾ Master module

⁽²⁾ Slave module

NOTE: each master module can be combined with up to 5 slave modules of any type, with a distance between the first and last module of 2 metres.

Fluorescent lamp dimmers



N525 N526/02 N141/21 JB26C23

Type	Features			Programming							Reference
	Type / Modules	Outputs / Number	Maximum no. of ballasts per 58W output	Relay contacts	DALI sensor connec.	Fault in lamp, ballast, hours, etc.	Individual program, per ballast	Scenarios	Max. Group Addr.	Max. Assign.	
JB 526C23	JB	1-10V / 2	60	2				•	120	120	5WG1526-4CB23
JB 527C23	JB	1-10V / 1	60	1				•	120	120	5WG1527-4CB23
N 526/02	N/6	1-10V / 3	50	3				•	35	47	5WG1526-1AB02
N 536D31	N/4	1-10V / 4	-	4				•	2000	2000	5WG1536-1DB31
N 536D51	N/8	1-10V / 8	-	8				•	2000	2000	5WG1536-1DB51
N 525E01	N/4	DALI / 8	8					•	108	107	5WG1525-1EB01
N 141/03	N/4	DALI / 1	64		•	•	•	•	4500	4500	5WG1141-1AB03
N 141/31	N/4	DALI / 2	64		•	•	•	•	3000	3000	5WG1141-1AB31
N 141/21	N/4	DALI / 2	64		•	•	•	•	4500	4500	5WG1141-1AB21

Actuators for blinds



N501 N523/___ RL 521/23 UP 520/13 UP 520/03 JB525C23

	Type	Features		Programming					Reference
		Channels - Contact ct. (A)	Type / Modules	Power supply	Final pos. detec.	Additional	Solar tracking	Scenarios	
DIN RAIL MOUNTING	N 543D31	4/6	N/4	Bus	•	Log. func.	•	•	5WG1543-1DB31
	N 543D51	8/6	N/8	Bus	•	Log. func.	•	•	5WG1543-1DB51
	N 523/04	4/6	N/4	230V AC			•		5WG1523-1AB04
	N 524/01	4/1	N/4	24V AC			•		5WG1524-1AB01
	N 501/01	4/6	N/8	230V AC		x8 voltage inp.		•	•
FLUSH-MOUNTED	UP 520/03	1/6	UP push-button	Bus	•		•	•	5WG1520-2AB03
	UP 520/13	1/6	UP	Bus	•		•	•	5WG1520-2AB13
	UP 520/31	1/6	UP	Bus		x2 binary inp.			5WG1520-2AB31
CONTROL BOX	RS 520/23	1/6	RS	Bus	•		•	•	5WG1520-2AB23
	RL 521/23	2/6	RL	Bus	•		•	•	5WG1521-4AB23
UL/NEMA Box	JB 520C23	2/6	RL	Bus	•	UL	•	•	5WG1520-4CB23
	JB 521C23	2/6	RL	Bus	•	UL	•	•	5WG1521-4CB23

Light level controllers



5WG1251-2AB11 5WG1251-2AB12

Tipo	Description	Colour	Reference
UP251	Passive wall-mounted passive infrared detector for stairs and corridors	White (similar to RAL 9010)	5WG1251-2AB11
UP251	Passive wall-mounted passive infrared detector for stairs and corridors	Black (similar to RAL 9005)	5WG1251-2AB12

Technology for smart buildings and homes

HVAC



RS 510K23

	Type	Description	Outputs	Inputs	Modules	Reference
CONTROL BOX	RS 510/23	2-output module to control electro-thermal actuators	2 x 24...230 V CA 6 24 V CC		RS	5WG1510-2KB23

Flush-mounted temperature sensors



AQR2570NF

AQR2530NNW

Front module / Type	Humidity range	Temperature range	Air quality indicator	Reference
AQR2530NNW				S55720-S137
AQR2532NNW		0 .. 50°C		S55720-S136
AQR2533NNW	0...100% hr			S55720-S140
AQR2535NNW	0...100% hr	0 .. 50°C		S55720-S141
AQR2535NNWQ	0...100% hr	0 .. 50°C	LED	S55720-S219
Base Module / Type	Air quality range	Standard	Measurement	Reference
AQR2570NF		CEE/VDE	70,8 X 70,8 mm	S55720-S203
AQR2576NF	0 ... 5000 ppm	CEE/VDE	70,8 X 70,8 mm	S55720-S207

Surface-mounted temperature



QMX3.P02 QMX3.P37 QMX3.P74 QMX3.P02-1BSC QMX3.P37-1BSC QMX3.P74-1BSC

Type	PID Control	Threshold value for RH and CO ₂	HMI Function	Manual fan speed interruption	Operating mode	Presence function	Operation of the lighting system, blind and scene	Colour	Sensor	Reference
QMX3.P30	•	•				•		Titan white	T	S55624-H103
QMX3.P30-1BSC	•	•				•		Black	T	S55624-H123
QMX3.P70	•	•	(1)					Titan white	T/HR/CO2	S55624-H104
QMX3.P70-1BSC	•	•	(1)					Black	T/HR/CO2	S55624-H125
QMX3.P34	•	•	•	•	•	•		Titan white	T	S55624-H105
QMX3.P34-1BSC	•	•	•	•	•	•		Black	T	S55624-H126
QMX3.P74	•	•	•	•	•	•		Titan white	T/HR/CO2	S55624-H106
QMX3.P74-1BSC	•	•	•	•	•	•		Black	T/HR/CO2	S55624-H127
QMX3.P02	•	•					•	Titan white	T	S55624-H107
QMX3.P02-1BSC	•	•					•	Black	T	S55624-H128
QMX3.P37	•	•	•	•	•	•	•	Titan white	T	S55624-H108
QMX3.P37-1BSC	•	•	•	•	•	•	•	Black	T	S55624-H129

⁽¹⁾ Multi-colour LED (CO₂ indication), green, orange or red. The LCD of all sensors can be shown as text or as a value.

Compact controller for VAV applications



RDG405KN

Type	Analogue input	Air quality sensor bus	Bus consumption (mA)	Colour	Reference
RDG405KN	•	•	5	Titan white	S55770-T165

Semi-flush mounted compact controllers for universal applications, heat pumps and fan-coils



RDF600KN

RDF600KN/S

RDF800KN

Type	Operating voltage	Control outputs			Mounting box	Reference
		3 Pos	On - Off	KNX push-buttons		
RDF600KN	230V AC	•	•		Standard	S55770-T293
RDF600KN/S	230V AC	•	•	•	Standard	S55770-T400
RDF800KN	230V AC	•	•		Standard	S55770-T350

Technology for smart buildings and homes

Surface mounted compact controllers for universal applications, heat pumps and fan-coils



RDG200KN RDG260KN

Type	Operating voltage	Temperature control outputs				Fan		Humidity	LCD	Reference
		On - Off	PWM	3 Pos	0-10V	3 vel	0-10V			
RDG200KN	220V/24V AC	•	•	•		•	•	•	•	S55770-T409
RDG260KN	24V AC	•			•	•	•	•	•	S55770-T412

Both models offer the NFC configuration option and the configuration of the state of environmental efficiency (green leaf).

KNX actuators for HVAC valves



Actuator for 5 Nm KNX ball valve S55499-D203
GDB111.9E/KN



Actuator for 5 Nm KNX ball valve S55499-D207
GLB111.9E/KN

120 N proportional actuator SWG1562-7AB02
AP 562/02
For valves with LED position indicator,
with adapters for Siemens valves,
V...I46 ..., V...P47 ...

Compact controllers for VAV



Thermostat with KNX communications S55770-T165
RDG400KN
Surface-mounted, for VAV applications.



Thermostat with KNX communications S55770-T348
RDG405KN
Surface mounted for VAV applications with built-in air quality sensor.

VAV actuators



Door actuator
VAV KNX 5 Nm
Type: GDB181.1E/KN
S55499-D134



Door actuator
VAV KNX 10 N
GLB181.1E/KN
S55499-D135

Accessories for compact controllers



Magnetic contact
Type: S 290/11
For doors or windows, titan white colour.
5WG1290-7AB11

BJC

Cetact

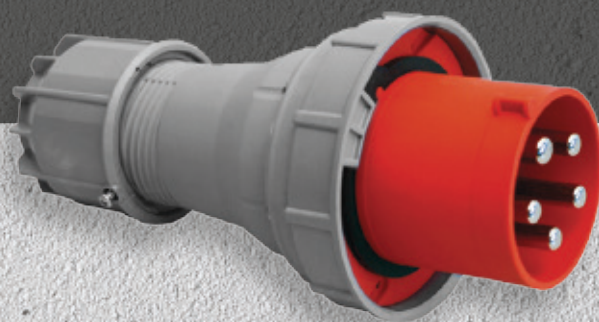



CETACT®
 16 A-500 V
 32 A, 63 A y 125 A – 750 V
 IP44 protection degree (16 A, 32 A),
 IP67 (63 A, 125 A)

The CETACT® plugs, socket outlets and connectors for industrial low voltage installations are designed in accordance with UNE-EN 60309-1 and UNE-EN 60309-2 standards.

The CETACT® range is available in 2P+E, 3P+E, 3P+N+E, in the following versions: Wall and panel mounted socket outlets, connectors and plugs

Characteristics of the materials:

Mention should be made of the technical properties of the polymers used in the manufacture of the CETACT® system insulation pieces, which give :

- Adequate resistance to abnormal heat and fire. Exceeds the self-extension test of incandescent wire at 850 °C (UNE-EN 60695-2 -1).
- Excellent dielectric and insulation characteristics.
- High heat stability.
- High mechanical resistance.
- High resistance to chemical and atmospheric agents.
- High resistance to UV radiation.

Functional features:

The CETACT® system achieves two important characteristics: the reliability of service and user safety. Thanks to the qualities of the materials used and the high mechanical stability of the coupling between socket and plug ensure reliability and continuity of operation.

The fulfil for the specifications of the standard implies safety, since:

- It is impossible to attach sockets and plugs if they do not match all of your rated characteristics: current, voltage, number of contacts and frequency.
- All of them have earthed contacts that connect before and disconnect after than the active contacts.
- They have a mechanical interlock. The 63 and 125 A models also have an auxiliary pole for an electrical interlocking (on request).
- The mobile accessories are equipped with cable glands to ensure a perfect hold of the conductors.
- The plugs and connectors are equipped with a cable gland for the rewiring of the cable. The assembly and disassembly of both, for its wiring, is made without screws "Twist System". This means a considerable saving of installation time

Product range and applications:

As indicated at the start, the combination of differing nominal characteristics gives rise to an extensive range including more than 300 different products.

The characteristics disclosed here, and the wide range of products, make CETACT® suitable for general industry, agricultural installations, shipyards, warehouses, works, laboratories, etc.

IP44 Wall-mounted socket outlets



	Code	N.º poles	Voltage	Earth position	Units per box
16 A	CT-9963	2P+T	200+250 V	6 h	10
	CT-9971	3P+T	380+415 V	6 h	10
	CT-9981	3P+N+T	200/346+240/415 V	6 h	10
32 A	CT-9964	2P+T	200+250 V	6 h	10
	CT-9972	3P+T	380+415 V	6 h	10
	CT-9982	3P+N+T	200/346+240/415 V	6 h	10

IP67 Wall-mounted socket outlets



	Code	N.º poles	Voltage	Earth position	Units per box
63 A	CT-9946	3P+T	380+415 V	6 h	1
	CT-9947	3P+N+T	200/346+240/415 V	6 h	2

IP 67 Panel-mounted tilted socket outlets



	Code	N.º poles	Voltage	Earth position	Units per box
16 A	CT-9967	2P+T	200+250 V	6 h	10
	CT-9975	3P+T	380+415 V	6 h	10
	CT-9985	3P+N+T	200/346+240/415 V	6 h	10
32 A	CT-9968	2P+T	200+250 V	6 h	10
	CT-9976	3P+T	380+415 V	6 h	10
	CT-9986	3P+N+T	200/346+240/415 V	6 h	10

IP67 Panel-mounted socket outlets, angled



	Code	N.º poles	Voltage	Earth position	Units per box
16 A	CT-71363	2P+T	200+250 V	6 h	2
	CT-71473	3P+T	380+415 V	6 h	2
	CT-71483	3P+N+T	200/346+240/415 V	6 h	2
32 A	CT-71367	2P+T	200+250 V	6 h	2
	CT-71477	3P+T	380+415 V	6 h	2
	CT-71487	3P+N+T	200/346+240/415 V	6 h	2

We can supply any time position within the UNE-EN 60309-1 / 60309-2 standard on request.

IP67 Panel-mounted socket outlets, straight

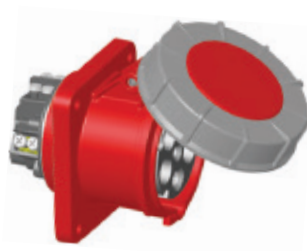

The plugs and connectors have a cable gland for retaining the cable. The assembly and disassembly of both, for connecting wires, is done without screws ("Twist System"). This means a considerable saving on installation time.

	Code	N.º poles	Voltage	Earth position	Units per box
63 A	CT-9948	3P+T	380+415 V	6 h	2
	CT-9949	3P+N+T	200/346+240/415 V	6 h	2
125 A	CT-9954	3P+T	380+415 V	6 h	2
	CT-9955	3P+N+T	200/346+240/415 V	6 h	2

IP44 Connectors



	Code	N.º poles	Voltage	Earth position	Units per box
16 A	CT-71213	2P+T	200+250 V	6 h	10
	CT-71214	3P+T	380+415 V	6 h	10
	CT-71215	3P+N+T	200/346+240/415 V	6 h	10
32 A	CT-71223	2P+T	200+250 V	6 h	10
	CT-71224	3P+T	380+415 V	6 h	10
	CT-71225	3P+N+T	200/346+240/415 V	6 h	10

IP67 Connectors



	Code	N.º poles	Voltage	Earth position	Units per box
16 A	CT-73303	2P+T	200+250 V	6 h	2
	CT-73413	3P+T	380+415 V	6 h	2
	CT-73423	3P+N+T	200/346+240/415 V	6 h	2
32 A	CT-73306	2P+T	200+250 V	6 h	2
	CT-73416	3P+T	380+415 V	6 h	2
	CT-73426	3P+N+T	200/346+240/415 V	6 h	2



	Code	N.º poles	Voltage	Earth position	Units per box
63 A	CT-9950	3P+T	380+415 V	6 h	2
	CT-9951	3P+N+T	200/346+240/415 V	6 h	2
125 A	CT-9956	3P+T	380+415 V	6 h	2
	CT-9957	3P+N+T	200/346+240/415 V	6 h	2

We can supply any time position within the UNE-EN 60309-1 / 60309-2 standard on request.

IP44 plugs



	Code	N.º poles	Voltage	Earth position	Units per box
16 A	CT-71013	2P+T	200+250 V	6 h	10
	CT-71014	3P+T	380+415 V	6 h	10
	CT-71015	3P+N+T	200/346+240/415 V	6 h	10
32 A	CT-71023	2P+T	200+250 V	6 h	10
	CT-71024	3P+T	380+415 V	6 h	10
	CT-71025	3P+N+T	200/346+240/415 V	6 h	10

IP67 plugs



	Code	N.º poles	Voltage	Earth position	Units per box
16 A	CT-77303	2P+T	200+250 V	6 h	2
	CT-77413	3P+T	380+415 V	6 h	2
	CT-77423	3P+N+T	200/346+240/415 V	6 h	2
32 A	CT-77306	2P+T	200+250 V	6 h	2
	CT-77416	3P+T	380+415 V	6 h	2
	CT-77426	3P+N+T	200/346+240/415 V	6 h	2



	Code	N.º poles	Voltage	Earth position	Units per box
63 A	CT-9952	3P+T	380+415 V	6 h	2
	CT-9953	3P+N+T	200/346+240/415 V	6 h	2
125 A	CT-9958	3P+T	380+415 V	6 h	2
	CT-9959	3P+N+T	200/346+240/415 V	6 h	2

IP44 angle plugs



	Code	N.º poles	Voltage	Earth position	Units per box
16 A	CT-75302	2P+T	200+250 V	6 h	2
	CT-75412	3P+T	380+415 V	6 h	2
	CT-75422	3P+N+T	200/346+240/415 V	6 h	2

We can supply any time position within the UNE-EN 60309-1 / 60309-2 standard on request.

IP44 Wall-mounted inlets



	Code	N.º poles	Voltage	Earth position	Units per box
16 A	CT-9945	2P+T	200-250 V	6 h	10
	CT-9979	3P+T	380-415 V	6 h	10
32 A	CT-9962	2P+T	200-250 V	6 h	10
	CT-9980	3P+T	380-415 V	6 h	10
	CT-9990	3P+N+T	200/346-240/415 V	6 h	10

IP67 Semi-mounted connector bases



	Code	N.º poles	Voltage	Earth position	Units per box
63 A	CT-9991	3P+N+T	200/346-240/415 V	6 h	2

COLOUR CODE AND EARTH POSITION

(according to UNE-EN 60309-2)

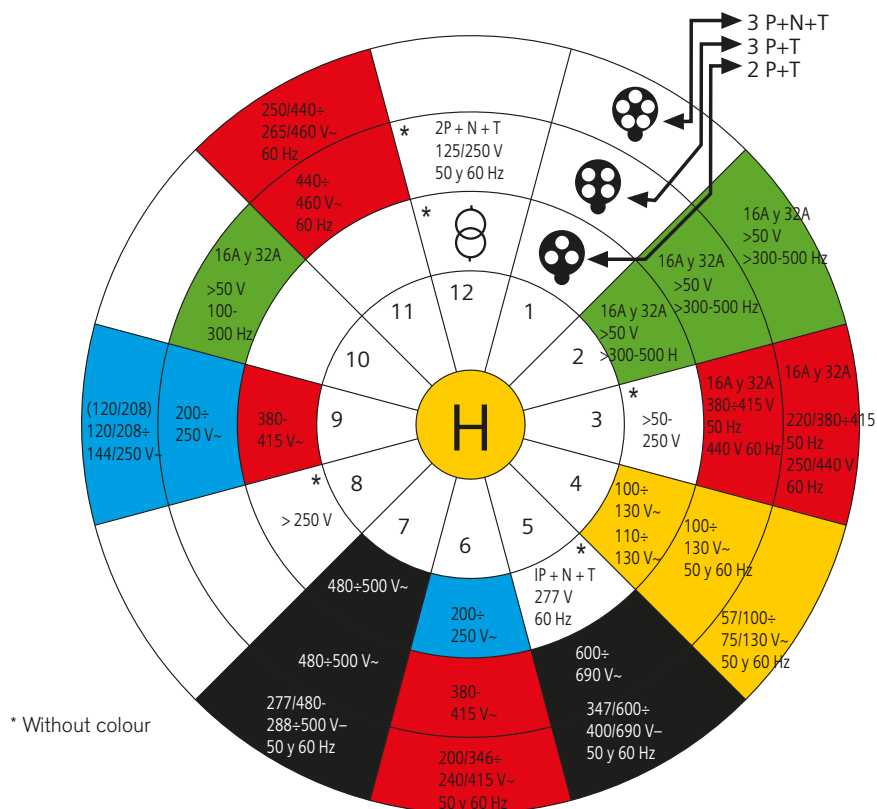

All socket outlets are manufactured in different colours, making it possible to easily differentiate between the different voltages and frequencies. We can supply any time position within the UNE-EN 60309-1 / 60309-2 standard on request.

N° poles	FREQUENCY HZ	VOLTAGE V		EARTH POSITION		COLOUR	WALL-MOUNTED SOCKET OUTLETS			PANEL-MOUNTED SOCKET OUTLETS			
		CEE 17*	UNE-EN 60309-2	16 AND 32 A	63 AND 125 A		16 A IP44	32 A IP44	63 A IP67	16 A		32 A	
										IP44	IP67	IP44	IP67
2P+E	50 and 60	110+130	100+130	4	4	YELLOW	CT-9963-4	CT-9964-4		CT-9967-4	CT-71363-4	CT-9968-4	CT-71367-4
		220+240	220+250	6	6	BLUE	CT-9963	CT-9964		CT-9967	CT-71363	CT-9968	CT-71367
	60	-	277	5	5	(3)	CT-9963-5	CT-9964-5		CT-9967-5		CT-9968-5	
	50 and 60	380+415	380+415	9	9	RED	CT-9963-9	CT-9964-9		CT-9967-9	CT-71363-9	CT-9968-9	CT-71367-9
		-	480+500	7	7	BLACK	CT-9963-7	CT-9964-7		CT-9967-7	CT-71363-7	CT-9968-7	CT-71367-7
		Circuit separation transformer	Circuit separation transformer	12	12	(3)	CT-9963-12	CT-9964-12		CT-9967-12		CT-9968-12	
	>300+500 incl.	>50	>50	2	-	GREEN	CT-9963-2	CT-9964-2		CT-9967-2	CT-71363-2	CT-9968-2	CT-71367-2
	Continuous current	50+250	50+250 incl.	3	3	(3)	CT-9963-3	CT-9964-3		CT-9967-3		CT-9968-3	
>250		>250	8	8	(3)	CT-9963-8	CT-9964-8		CT-9967-8		CT-9968-8		
3P+E	50 and 60	110+130	110+130	4	4	YELLOW	CT-9971-4	CT-9972-4	CT-9946-4	CT-9975-4	CT-71473-4	CT-9976-4	CT-71477-4
		220+240	200+250	9	9	BLUE	CT-9971-9	CT-9972-9	CT-9946-9	CT-9975-9	CT-71473-9	CT-9976-9	CT-71477-9
		380+415	380+415	6	6	RED	CT-9971	CT-9972	CT-9946	CT-9975	CT-71473	CT-9976	CT-71477
	60	440	440+460 (1)	11	11	RED	CT-9971-11	CT-9972-11	CT-9946-11	CT-9975-11		CT-9976-11	
	50 and 60	500	480+500	7	7	BLACK	CT-9971-7	CT-9972-7	CT-9946-7	CT-9975-7	CT-71473-7	CT-9976-7	CT-71477-7
		750	600+690	5	5	BLACK	CT-9971-5	CT-9972-5	CT-9946-5	CT-9975-5		CT-9976-5	
		125/250 monophase	125/250 monophase	12	12	(3)	CT-9971-12	CT-9972-12	CT-9946-12	CT-9975-12		CT-9976-12	
	50 60	-	380 440 (2)	3	-	RED	CT-9971-3	CT-9972-3		CT-9975-3		CT-9976-3	
	100+300 incl.	>50	>50	10	-	GREEN	CT-9971-10	CT-9972-10		CT-9975-10	CT-71473-10	CT-9976-10	CT-71477-10
	>300+500 incl.	>50	>50	2	-	GREEN	CT-9971-2	CT-9972-2		CT-9975-2	CT-71473-2	CT-9976-2	CT-71477-2
3P+N+E	50 and 60	110+130	57/100+75/130	4	4	YELLOW	CT-9981-4	CT-9982-4	CT-9947-4	CT-9985-4	CT-71483-4	CT-9986-4	CT-71487-4
		127/220+138/240	120/208+144/250	9	9	BLUE	CT-9981-9	CT-9982-9	CT-9947-9	CT-9985-9	CT-71483-9	CT-9986-9	CT-71487-9
		220/380+240/415	200/346+240/415	6	6	RED	CT-9981	CT-9982	CT-9947	CT-9985	CT-71483	CT-9986	CT-71487
		500	277/480+288/500	7	7	BLACK	CT-9981-7	CT-9982-7	CT-9947-7	CT-9985-7	CT-71483-7	CT-9986-7	CT-71487-7
		750	347/600+400/690	5	5	BLACK	CT-9981-5	CT-9982-5	CT-9947-5	CT-9985-5		CT-9986-5	
	60	250/440	250/440+265/460 (1)	11	11	RED	CT-9981-11	CT-9982-11	CT-9947-11	CT-9985-11		CT-9986-11	
	50 60	-	220/380 250/440 (1)	3	-	RED	CT-9981-3	CT-9982-3		CT-9985-3		CT-9986-3	
	>300+500 incl.	>50	>50	2	-	GREEN	CT-9981-2	CT-9982-2		CT-9985-2	CT-71483-2	CT-9986-2	CT-71487-2
All types	All the nominal voltages and/or frequencies not covered by other configurations			1	1								

PANEL-MOUNTED SOCKET OUTLETS		CONNECTORS						PLUGS						ANGLE PLUGS	WALL-MOUNTED INLETS	
63 A IP67	125 A IP67	16 A		32 A		63 A IP67	125 A IP67	16 A		32 A		63 A IP67	125 A IP67	16 A IP44	16 A IP44	32 A IP44
		IP44	IP67	IP44	IP67			IP44	IP67	IP44	IP67					
		CT-71213-4	CT-73303-4	CT-71223-4	CT-73306-4			CT-71013-4	CT-77303-4	CT-71023-4	CT-77306-4					
		CT-71213	CT-73303	CT-71223	CT-73306			CT-71013	CT-77303	CT-71023	CT-77306			CT-75302		CT-9962
		CT-71213-5		CT-71223-5				CT-71013-5		CT-71023-5						
		CT-71213-9	CT-73303-9	CT-71223-9	CT-73306-9			CT-71013-9	CT-77303-9	CT-71023-9	CT-77306-9					
		CT-71213-7	CT-73303-7	CT-71223-7	CT-73306-7			CT-71013-7	CT-77303-7	CT-71023-7	CT-77306-7					
		CT-71213-12		CT-71223-12	CT-73306-2			CT-71013-12		CT-71023-12						
		CT-71213-2	CT-73303-2	CT-71223-2				CT-71013-2	CT-77303-2	CT-71023-2	CT-77306-2					
		CT-71213-3		CT-71223-3				CT-71013-3		CT-71023-3						
		CT-71213-8		CT-71223-8				CT-71013-8		CT-71023-8						
CT-9948-4	CT-9954-4	CT-71214-4	CT-73413-4	CT-71224-4	CT-73416-4	CT-9950-4	CT-9956-4	CT-71014-4	CT-77413-4	CT-71024-4	CT-77416-4	CT-9952-4	CT-9958-4		CT-9979-4	CT-9980-4
CT-9948-9	CT-9954-9	CT-71214-9	CT-73413-9	CT-71224-9	CT-73416-9	CT-9950-9	CT-9956-9	CT-71014-9	CT-77413-9	CT-71024-9	CT-77416-9	CT-9952-9	CT-9958		CT-9979-9	CT-9980-9
CT-9948	CT-9954	CT-71214	CT-73413	CT-71224	CT-73416	CT-9950	CT-9956	CT-71014	CT-77413	CT-71024	CT-77416	CT-9952	CT-9958	CT-75412	CT-9979	CT-9980
CT-9948-11	CT-9954-11	CT-71214-11		CT-71224-11		CT-9950-11	CT-9956-11	CT-71014-11		CT-71024-11		CT-9952-11	CT-9958-11		CT-9979-11	CT-9980-11
CT-9948-7	CT-9954-7	CT-71214-7	CT-73413-7	CT-71224-7	CT-73416-7	CT-9950-7	CT-9956-7	CT-71014-7	CT-77413-7	CT-71024-7	CT-77416-7	CT-9952-7	CT-9958-7		CT-9979-7	CT-9980-7
CT-9948-5	CT-9954-5	CT-71214-5		CT-71224-5		CT-9950-5	CT-9956-5	CT-71014-5		CT-71024-5		CT-9952-5	CT-9958-5		CT-9979-5	CT-9980-5
CT-9948-12	CT-9954-12	CT-71214-12		CT-71224-12		CT-9950-12	CT-9956-12	CT-71014-12		CT-71024-12		CT-9952-12	CT-9958-12		CT-9979-12	CT-9980-12
		CT-71214-3		CT-71224-3				CT-71014-3		CT-71024-3					CT-9979-3	CT-9980-3
		CT-71214-10	CT-73413-10	CT-71224-10	CT-73416-10			CT-71014-10	CT-77413-10	CT-71024-10	CT-77416-10				CT-9979-10	CT-9980-10
		CT-71214-2	CT-73413-2	CT-71224-2	CT-73416-2			CT-71014-2	CT-77413-2	CT-71024-2	CT-77416-2				CT-9979-2	CT-9980-2
CT-9949-4	CT-9955-4	CT-71215-4	CT-73423-4	CT-71225-4	CT-73426-4	CT-9951-4	CT-9957-4	CT-71015-4	CT-77423-4	CT-71025-4	CT-77426-4	CT-9953-4	CT-9959-4			
CT-9949-9	CT-9955-9	CT-71215-9	CT-73423-9	CT-71225-9	CT-73426-9	CT-9951-9	CT-9957-9	CT-71015-9	CT-77423-9	CT-71025-9	CT-77426-9	CT-9953-9	CT-9959-9			
CT-9949	CT-9955	CT-71215	CT-73423	CT-71225	CT-73426	CT-9951	CT-9957	CT-71015	CT-77423	CT-71025	CT-77426	CT-9953	CT-9959	CT-75422		
CT-9949-7	CT-9955-7	CT-71215-7	CT-73423-7	CT-71225-7	CT-73426-7	CT-9951-7	CT-9957-7	CT-71015-7	CT-77423-7	CT-71025-7	CT-77426-7	CT-9953-7	CT-9959-7			
CT-9949-5	CT-9955-5	CT-71215-5		CT-71225-5		CT-9951-5	CT-9957-5	CT-71015-5		CT-71025-5		CT-9953-5	CT-9959-5			
CT-9949-11	CT-9955-11	CT-71215-11		CT-71225-11		CT-9951-11	CT-9957-11	CT-71015-11		CT-71025-11		CT-9953-11	CT-9959-11			
		CT-71215-3		CT-71225-3				CT-71015-3		CT-71025-3						
		CT-71215-2	CT-73423-2	CT-71225-2	CT-73426-2			CT-71015-2	CT-77423-2	CT-71025-2	CT-77426-2					

(1) Primarily for use on board ships.
(2) Only for refrigerated containers (ISO standard).
(3) is supplied without a specific colour.
* Equivalent to the former Publication 17 of the International Commission of Certification of Conformity of Electrical Equipment.

Extra-Low voltage panel-mounted socket outlets, straight



	Code	N.º poles	Voltage	Earth position	Units per box
Protected IP44 16 A	I-362	2P	20÷25 V	—	1



	Code	N.º poles	Voltage	Earth position	Units per box
Watertight IP67 16 A	I-3622	2P	20÷25 V	—	1

We can supply any time position within the UNE-EN 60309-1 / 60309-2 standard on request.

20÷25 V 40÷50 V > 60 Hz

Extra-Low voltage plugs



	Code	N.º poles	Voltage	Earth position	Units per box
Protected IP44 16 A	I-062	2P	20÷25 V	—	1



	Code	N.º poles	Voltage	Earth position	Units per box
Watertight IP67 16 A	I-0622	2P	20÷25 V	—	1

Extra-Low voltage connectors



	Code	N.º poles	Voltage	Earth position	Units per box
Protected IP44 16 A	I-262	2P	20+25 V	—	1

We can supply any time position within the UNE-EN 60309-1 / 60309-2 standard on request.

20+25 V | 40+50 V | > 60 Hz

Adapters



I-2302
Cetact® plug (16A 2P+E, 6h)
on Schuko® socket outlet
16 A 2P+T 6 h
16 A 2P+T lateral
Packing 5



I-2303
Shucko® plug on
Cetact® socket outlet (16A 2P+E, 6h)
Packing 5

BJC

**Watertight
surface-mounting
junction boxes
and accessories**



Watertight surface-mounting junction boxes and accessories



MARINER SERIES

The Mariner series offers a range of boxes and sets with inserts for areas with adverse weather, corrosive environments and industrial installations requiring a high degree of protection.

Characteristics:

Protection degree: IP54 S/UNE 20234.
Degree of protection against mechanical damage IK08 UNE-EN 50102.
Boxes, cases and opaque lids are made of ABS in a grey colour (RAL 7035).
Transparent polycarbonate case caps and cases.
Neoprene gaskets on all models.

ALUMINIUM SERIES

Boxes made in die-cast aluminium.
Conveniently protected by paint.
For installations in the open or in humid environments, and particularly where there is a need for high mechanical resistance.

Aluminium Series

Boxes made in die-cast aluminium, suitably protected by paint • For facilities in the open air or in humid environments, particularly where there is a need for high mechanical resistance • IP54-protection degree (UNE 20324), IK08 (UNE-EN 50102)



Square blank boxes

- 4022** Int. dimensions 90x90x42 mm
- 4032** Int. dimensions 110x110x45 mm
- 4042** Int. dimensions 130x130x50 mm
- 4052** Int. dimensions 150x150x65 mm
- 4053** With upper cap, Int. dimensions: 150x150x100 mm

Packing 1



Square boxes with 4 sides open

- 4020** Int. dimensions 90x90x42 mm
- 4030** Int. dimensions 110x110x45 mm
- 4040** Int. dimensions 130x130x50 mm
- 4050** Int. dimensions 150x150x65 mm

Packing 1



Rectangular boxes

Fixed cover • Blind

- 4063**
Int. dimensions 160x200x110 mm
- 4064**
Int. dimensions 200x250x120 mm

Packing 1



Rectangular boxes

Hinged cover • Blind

- 4065**
Int. dimensions 160x200x110 mm
- 4066**
Int. dimensions 200x250x120 mm

Packing 1

Cable glands and accessories



Cable glands

Made of unalterable and unbreakable plastic material.

	Thread	Ø Cable	
		Max.	Mín.
6290-M16	M16	9	5
6290-M20	M20	12	9
6290-M25	M25	18	14
6290-M32	M32	21	17
Packing 25			
6290-M40	M40	28	21
6290-M50	M50	35	28
Packing 10			

Interchangeable caps

Blind caps and threaded

Threaded caps

To ask for the cap with the required thread, add it at the end of the code

Ej.: **M25: 4060-M25** o **M50: 4101-M50.**

Aluminium	
Threaded	Blind
For 90 x 90mm boxes	
4060 Inputs: M16, M20, M25	4060-C
For 110x110 mm and 130x130 mm boxes	
4061 Inputs: M16, M20, M25, M32	4061-C
For 150 x 150mm boxes	
4062 Inputs: M16, M20, M25, M32, M40, M50	4062-C

Packing 50

BJC

Mounted and connected boxes



Mounted and connected boxes



EMPTY TCP BOXES

The TCP boxes have been specially designed to make assemblies with socket outlets with their corresponding protective components. The most important features can be summarised as:

Versatility. With only 4 types of boxes, whatever combination is required can be made, by placing socket outlets from 16 to 125 A, along with the appropriate electrical protection.

Safety. The high quality of the materials used means that the product offers IP55 protection according to UNE 20324, and Class-II insulation according to UNE-EN 611440, that allows it to be placed in highly aggressive environments.

Fast assembly. The accessibility of the interior elements and the ease with which they can be reworked (following the corresponding templates) allow any type of assembly to be carried out quickly.

These characteristics make these boxes indispensable for building work, industries with interchangeable manufacturing processes and autonomous portable installations, maintenance of public and auxiliary services, etc.



MARINER AND TCP BOXES

Highly recommended for building work, industries with interchangeable manufacturing processes and autonomous portable installations, maintenance of public and auxiliary services, etc.

Mariner specifications:

Bodies comprise ABS boxes and lids in a grey colour (RAL 7035).
Neoprene gaskets on all models.

TCP specifications:

Box, front panel and lid made of polycarbonate.
Box and panel in RAL 7035 grey.
Transparent lid in a smoke colour.
It accommodates modular 17.5 mm s / DIN 43880 elements.

The T-13, T-15 and T-17 boxes also offer unique advantages:

Models with greater capacity.

Practical opening and closing system with the practical transparent cover, with the possibility to change the opening method (left and right, or left to right).

Option for security lock using accessory T-10.

Fastening of front panel by easily accessible large insulating screws.

Front panel window with larger surface and cover with easily cut modular inserts, allowing the necessary modules to be used, leaving the set closed at all times.

Sealable box.

Height of the track-profile is adjustable via staggered ABS spacers.

Easy connection of modules to the track-profile.

Mounted and connected Mariner boxes.

ABS • Colour Grey RAL 7035 • IP44 protection degree (UNE 20324), IK08 (UNE-EN 50102) in a vertical position



I-6202-1

Socket outlets:
 - 2 Schuko® socket outlets with hinged lid, 16A 250V
 Given terminals of 16 mm²
 Packing 1



I-6203-1

Socket outlets:
 - 4 Schuko® socket outlets with hinged lid, 16A 250V
 Given terminals of 16 mm²
 Max. intensity 40 A
 Packing 1



I-6204-1

Socket outlets:
 - 2 Schuko® socket outlets with hinged lid, 16A 250V
 - 1 Cetact® panel-mounted socket outlet
 (3P+E, 16A, 6h, 380-415V)
 Given terminals of 16 mm²
 Packing 1



I-6204-2

Socket outlets:
 - 2 Schuko® socket outlets with hinged lid, 16A 250V
 - 1 Cetact® panel-mounted socket outlet
 (3P+E, 32A, 6h, 380-415V)
 Given terminals of 16 mm²
 Packing 1



I-6205-1

Socket outlets:
 - 3 Schuko® socket outlets with hinged lid, 16A 250V
 - 1 Cetact® panel-mounted socket outlet
 (3P+E, 16A, 6h, 380-415V)
 - 1 Cetact® panel-mounted socket outlet
 (3P+E, 32A, 6h, 380-415V)
 Given terminals of 2 5 mm²
 Packing 1

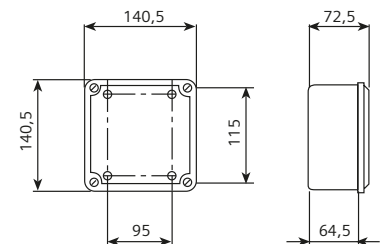

I-6203

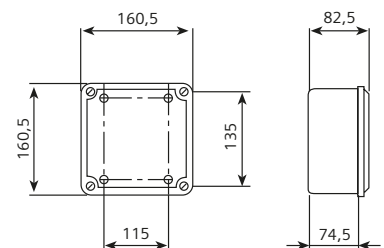

I-6204

Mounted and connected boxes with TCP protections

IP44-protection degree (UNE 20324), IK08 (UNE-EN 50102) set • Colour grey RAL 7035 • Boxes conform to EN 60439-3

The boxes are supplied with IP44 socket outlets and mounted Siemens circuit breakers (standard configurations), fully wired and connected.



TM-13-1

Box for 8 17.5 mm modules
 Socket outlets:
 - 2 Schuko® socket outlets with hinged lid, 16A 250V
 - 1 Cetact® panel-mounted socket outlet (3P+E, 16A, 6h, 380-415V)

Overload and Short circuit protection:
 - 1 Circuit breaker, 2P, 16A, 6kA, curve C
 - 1 Circuit breaker, 3P, 16A, 6kA, curve C
 Packing 1



TM-13-2

Box for 8 17.5 mm modules
 Socket outlets:
 - 2 Schuko® socket outlets with hinged lid, 16A 250V
 - 1 Cetact® panel-mounted socket outlet (3P+E, 32A, 6h, 380-415V)

Overload and Short circuit protection:
 - 1 Circuit breaker, 2P, 16A, 6kA, curve C
 - 1 Circuit breaker, 3P, 32A, 6kA, curve C
 Packing 1



TM-13-4

Box for 8 17.5 mm modules
 Socket outlets:
 - 4 Schuko® socket outlets with hinged lid, 16A 250V

Overload and Short circuit protection:
 - 2 Circuit breakers, 2P, 16A, 6kA, curve C
 Packing 1



TM-13-7

Box for 8 17.5 mm modules
 Socket outlets:
 - 2 Schuko® socket outlets with hinged lid, 16A 250V
 - 1 Cetact® panel-mounted socket outlet (3P+E, 16A, 6h, 380-415V)

Overload and Short circuit protection:
 - 1 Circuit breaker, 2P, 16A, 6kA, curve C
 - 1 Circuit breaker, 4P, 16A, 6kA, curve C
 Packing 1

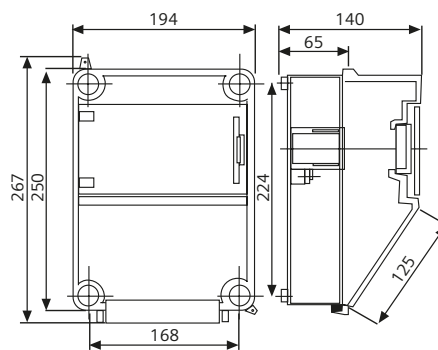

T-13



TM-15-1

Box for 8 17.5 mm modules
 Socket outlets:
 - 2 Schuko® socket outlets with hinged lid, 16A 250V
 - 1 Cetact® panel-mounted socket outlet (3P+E, 16A, 6h, 380-415V)
 - 1 Cetact® panel-mounted socket outlet (3P+E, 32A, 6h, 380-415V)

Overload and Short circuit protection:
 - 1 Circuit breaker, 2P, 16A, 6kA, curve C
 - 1 Circuit breaker, 3P, 16A, 6kA, curve C
 - 1 Circuit breaker, 3P, 32A, 6kA, curve C
 Packing 1

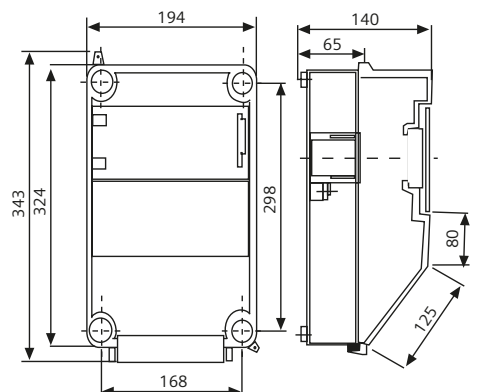

Mounted and connected boxes with TCP protections

IP44-protection degree (UNE 20324), IK08 (UNE-EN 50102) set • Colour grey RAL 7035 • Boxes conform to EN 60439-3

The boxes are supplied with IP44 socket outlets and mounted circuit breakers (standard configurations), fully wired and connected.



TM-15-2

Box for 8 17.5 mm modules

Socket outlets:

- 2 Schuko® socket outlets with hinged lid, 16A 250V
- 2 Cetact® panel-mounted socket outlets (3P+E, 16A, 6h, 380-415V)

Overload and Short circuit protection:

- 1 Circuit breaker, 2P, 16A, 6kA, curve C
- 2 Circuit breakers, 3P, 16A, 6kA, curve C

Packing 1

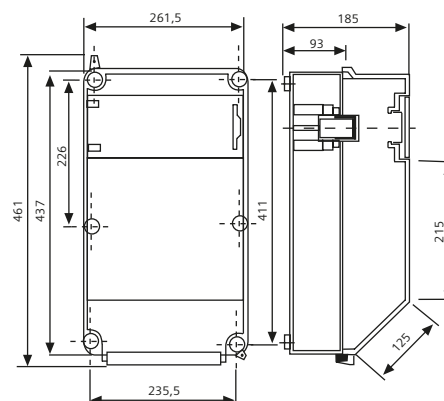

T-17



TM-17-1

Box for 12 17.5 mm modules

Socket outlets:

- 4 Schuko® socket outlets with hinged lid, 16A 250V
- 2 Cetact® panel-mounted socket outlets (3P+E, 16A, 6h, 380-415V)
- 1 Cetact® panel-mounted socket outlet (3P+E, 32A, 6h, 380-415V)

Overload and Short circuit protection:

- 2 Circuit breaker,s 1P+N, 16A, 6kA, curve C
- 2 Circuit breakers, 3P, 16A, 6kA, curve C
- 1 Circuit breaker, 3P, 32A, 6kA, curve C

Packing 1

Mounted and connected TCP boxes

Polycarbonate • Colour Grey RAL 7035 • IP44-protection degree (UNE 20324), IK08 (UNE-EN 50102) in a vertical position



T-13-1

Box for 8 17.5 mm modules

Socket outlets:

- 2 Schuko® socket outlets with hinged lid, 16A 250V
- 1 Cetact® panel-mounted socket outlet (3P+E, 16A, 6h, 380-415V)

Packing 1



T-13-2

Box for 8 17.5 mm modules

Socket outlets:

- 2 Schuko® socket outlets with hinged lid, 16A 250V
- 1 Cetact® panel-mounted socket outlet (3P+E, 32A, 6h, 380-415V)

Packing 1



T-13-3

Box for 8 17.5 mm modules

Socket outlets:

- 2 Schuko® socket outlets with hinged lid, 16A 250V

Packing 1



T-13-4

Box for 8 17.5 mm modules

Socket outlets:

- 4 Schuko® socket outlets with hinged lid, 16A 250V

Packing 1



T-13-5

Box for 8 17.5 mm modules

Socket outlets:

- 1 Cetact® panel-mounted socket outlet (3P+N+E, 63A, 6h, 200/346 - 200/415V)

Packing 1

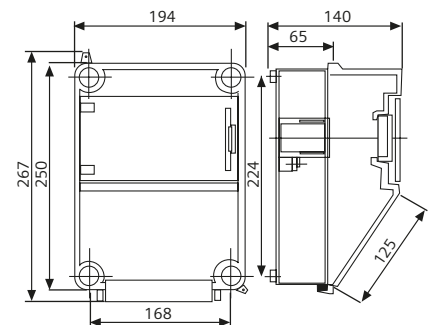

Mounted and connected TCP boxes



T-13-6

Box for 8 17.5 mm modules

Socket outlets:

- 2 Schuko® socket outlets with hinged lid, 16A 250V
- 1 Cetact® extra-low voltage panel-mounted socket outlet (2P, 16A, 20-25V extra-low voltage)

Packing 1



T-13-7

Box for 8 17.5 mm modules

Socket outlets:

- 2 Schuko® socket outlets with hinged lid, 16A 250V
- 1 Cetact® panel-mounted socket outlet (3P+N+E, 16A, 6h, 380-415V)

Packing 1



T-13-8

Box for 8 17.5 mm modules

Socket outlets:

- 2 Schuko® socket outlets with hinged lid, 16A 250V
- 1 Cetact® panel-mounted socket outlet (3P+N+E, 32A, 6h, 380-415V)

Packing 1

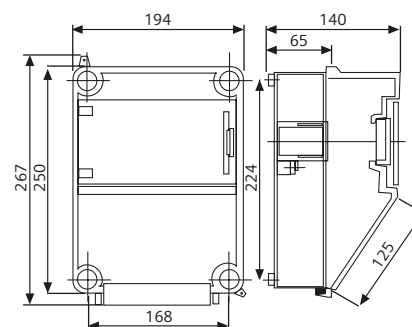

T-13



T-15-1

Box for 8 17.5 mm modules

Socket outlets:

- 2 Schuko® socket outlets with hinged lid, 16A 250V
- 1 Cetact® panel-mounted socket outlet (3P+E, 16A, 6h, 380-415V)
- 1 Cetact® panel-mounted socket outlet (3P+E, 32A, 6h, 380-415V)

Packing 1



T-15-2

Box for 8 17.5 mm modules

Socket outlets:

- 2 Schuko® socket outlets with hinged lid, 16A 250V
- 2 Cetact® panel-mounted socket outlets (3P+E, 16A, 6h, 380-415V)

Packing 1



T-15-3

Box for 8 17.5 mm modules

Socket outlets:

- 2 Schuko® socket outlets with hinged lid, 16A 250V
- 2 Cetact® panel-mounted socket outlets (3P+E, 32A, 6h, 380-415V)

Packing 1



T-15-4

Socket outlets:

- 2 Schuko® socket outlets with hinged lid, 16A 250V
- 1 Cetact® panel-mounted socket outlet (3P+N+E, 16A, 6h, 380-415V)
- 1 Cetact® panel-mounted socket outlet (3P+N+E, 32A, 6h, 380-415V)

Packing 1

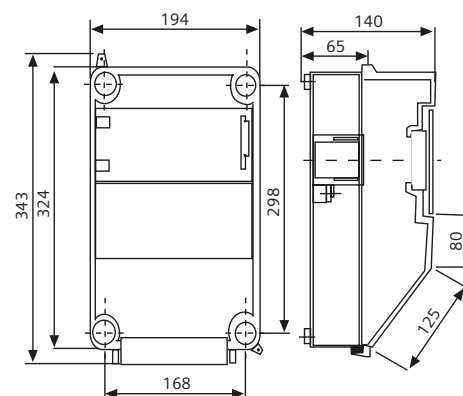

T-15

Any combination is available on request.

Mounted and connected TCP boxes



T-15-5

Box for 8 17.5 mm modules

Socket outlets:

- 2 Schuko® socket outlets with hinged lid, 16A 250V
- 2 Cetact® panel-mounted socket outlets (3P+N+E, 16A, 6h, 380-415V)

Packing 1



T-15-6

Box for 8 17.5 mm modules

Socket outlets:

- 2 Schuko® socket outlets with hinged lid, 16A 250V
- 2 Cetact® panel-mounted socket outlets (3P+N+E, 32A, 6h, 380-415V)

Packing 1

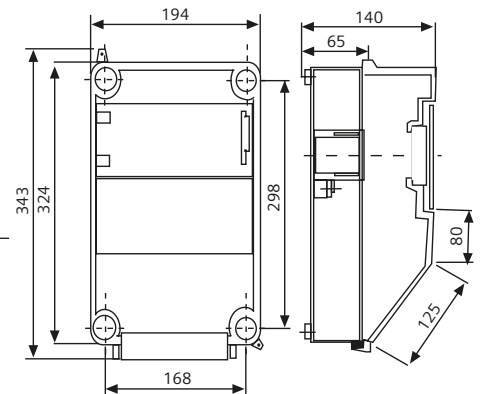

T-15



T-17-1

Box for 12 17.5 mm modules

Socket outlets:

- 2 Schuko® socket outlets with hinged lid, 16A 250V
- 2 Cetact® panel-mounted socket outlets (3P+E, 16A, 6h, 380-415V)
- 1 Cetact® panel-mounted socket outlet (3P+E, 32A, 6h, 380-415V)

Packing 1



T-17-2

Box for 12 17.5 mm modules

Socket outlets:

- 3 Cetact® panel-mounted socket outlets (3P+E, 16A, 6h, 380-415V)
- 2 Cetact® panel-mounted socket outlets (3P+E, 32A, 6h, 380-415V)

Packing 1



T-17-3

Box for 12 17.5 mm modules

Socket outlets:

- 4 Schuko® socket outlets with hinged lid, 16A 250V
- 1 Cetact® panel-mounted socket outlet (3P+E, 16A, 6h, 380-415V)
- 1 Cetact® panel-mounted socket outlet (3P+E, 32A, 6h, 380-415V)

Packing 1

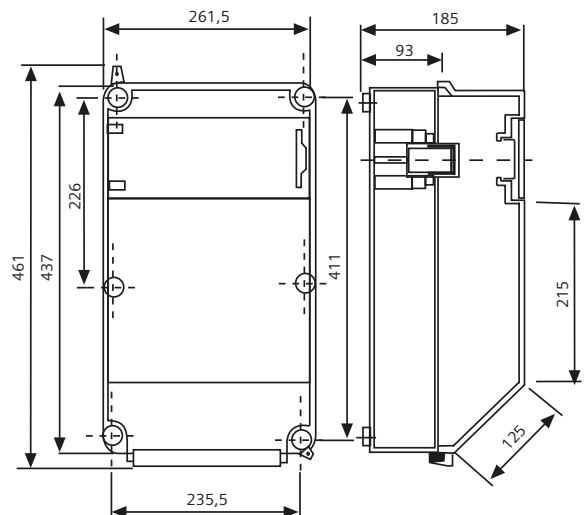

T-17

Bajo demanda se puede realizar cualquier combinación

Mounted boxes



Empty TCP boxes and accessories

Polycarbonate • Colour Grey RAL 7035 • IP55-protection degree (UNE 20324), IK08 (UNE-EN 50102) in a vertical position



T-13
TCP box with capacity for 8 17.5 mm modules

Packing 1

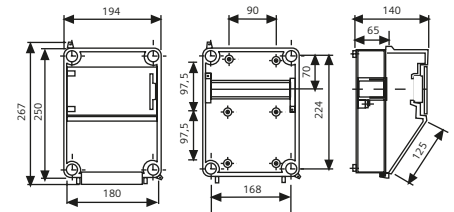

T-15
TCP box with capacity for 8 17.5 mm modules

Packing 1

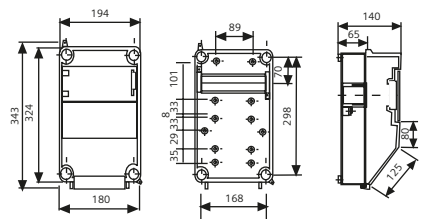

T-17
TCP box with capacity for 12 17.5 mm modules

Packing 1

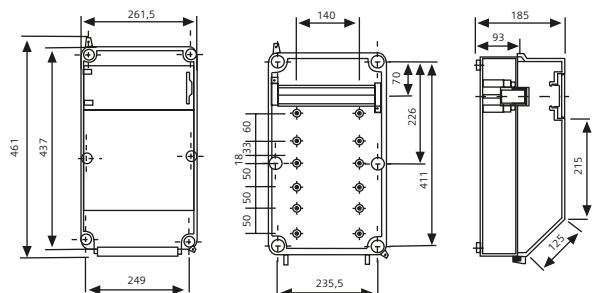

T-16 (IP54)
TCP box with capacity for 24 17.5 mm modules

Packing 1

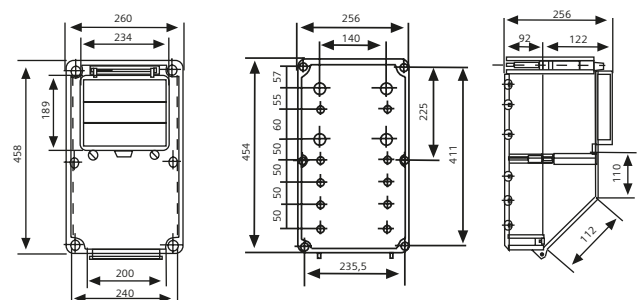

Empty TCP boxes and accessories



I-2316

Schuko® socket outlet with hinged lid, 16A, 250V, IP54

Packing 20

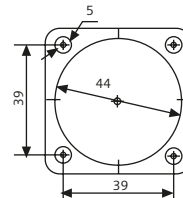

T-904 (M4)

T-905 (M5)

Screws with insulation head to secure box outlets avoiding possible indirect contacts (including nut).

Packing 50

Spare parts for boxes T-13, T-15 and T-17

RE-0226 Transparent door for T-13 y T-15.

Packing 1

RE-0227 Transparent door for T17.

Packing 1

RE-0228 Upper cap-box attachment screws T-13, T-15 y T-17.

Packing 1 (2 screws)

RE-0229 Upper cap-box attachment screws T-13, T-15 y T-17.

Packing 1 (2 screws)

Technical information

Iris, Iris plus & Mega dimensions

Dimensions of Iris frames

	85 x 84 mm
	85 x 155 mm
	85 x 226 mm
	85 x 296 mm
	156 x 84 mm
	228 x 84 mm
	299 x 84 mm

Material: Thermosetting (UREA)

Dimensions of Iris plus frames

	93 x 82 mm
	164 x 82 mm
	236 x 82 mm
	307 x 82 mm
	153 x 93 mm
	225 x 93 mm

Material: Thermosetting (UREA)

Dimensions of Mega frames

	90 x 90 mm
	161 x 90 mm
	232,5 x 90 mm
	304 x 90 mm
	90 x 161 mm
	90 x 232,5 mm
	90 x 304 mm

Material: Zamak or natural wood

Dimensions of the rockers and covers

	64 x 53 mm
--	------------

Material: Thermosetting (UREA)

Iris IP44 waterproof dimensions

Dimensions of BJC and Iris waterproof frames

	85 x 85 mm
	85 x 155 mm





Dimensions of the rockers and covers

	64 x 53 mm
--	------------

Material: Polycarbonate

Style dimensions

Dimensions of Style frames





	82 x 82 mm
	82 x 153 mm
	82 x 224 mm
	82 x 295 mm
	82 x 366 mm

Dimensions of the rockers and covers

	68 x 68 mm
---	------------

Miro dimensions

Dimensions of Miro frames





	90 x 90 mm
	90 x 161 mm
	90 x 232 mm
	90 x 303 mm

Dimensions of the rockers and covers

	55 x 55 mm
---	------------

Viva dimensions

Dimensions of BJC Viva frames

	86 x 86 mm
	86 x 157 mm
	86 x 228 mm
	86 x 299 mm

Dimensions of the rockers and covers

	50 x 50 mm
---	------------

Material: Thermoplastic (polycarbonate + ASA)

Coral dimensions

Dimensions of BJC Coral frames

	86 x 86 mm
	86 x 157 mm
	86 x 229 mm
	86 x 300 mm
	86 x 157 mm
	86 x 229 mm
	86 x 300 mm

Material: Self-extinguishing and thermo-resistant (Thermoset)

Dimensions of the rockers and covers

	64 x 46 mm
--	------------

Material: Self-extinguishing and thermo-resistant (Thermoset)

Sol dimensions

Dimensions of BJC Sol frames

	85 x 86 mm
	85 x 86 mm
	85 x 157 mm
	85 x 228 mm
	85 x 120 mm
	85 x 120 mm
	85 x 120 mm

Material: Termoendurente autoextinguible (UREA)

Dimensions of the rockers and covers

	46 x 46 mm
--	------------

	23 x 46 mm
--	------------

Material: Self-extinguishing and thermo-resistant (Thermoset)

Box dimensions

2373-I

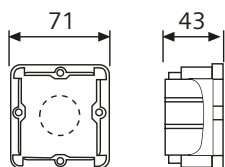

2341

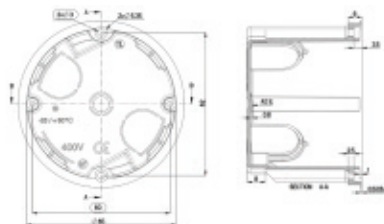

2342

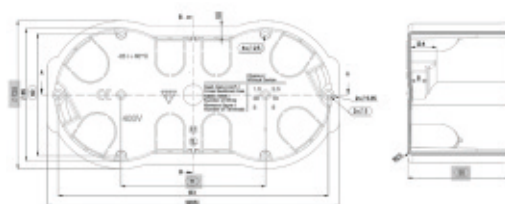

2343

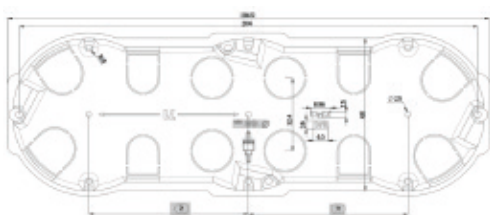

2344

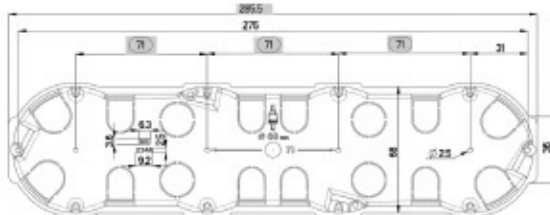

2345

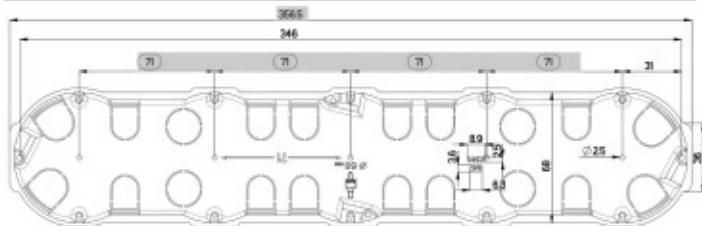

Compensation load for indicator lights

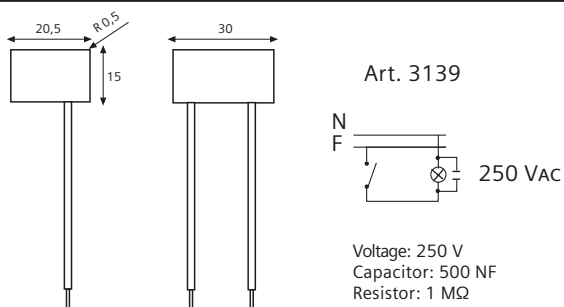

Switches

CLASSIFICATION OF INSERTS ACCORDING TO FUNCTION NUMBER
According to UNE-EN 60669-1

Function Number	Number of poles	Connections achievable	
1	1	One-way switch and push-button	
2	2	2 pole one-way switch	
5	1	Double one-way switch	
6	1	Two-way switch	
6+6	2	Double two-way switch	
7	1	Two-way switch junction (intermediate switch)	
6+1	2	Two-way switch + Push-button	

With the aim of facilitating the marketing and work both of wholesalers and installers, BJC sells the bjc Iris, Sol, Coral and Ibiza series separately:

- Sockets or main parts with a reference.
- Switches or covers with another reference.
- Installation frames also with another reference.

The user must bear in mind that the three components are essential for a correct and safe installation. Switches and covers must not be used on bases other than those indicated in this catalogue or in the instructions for use.

BJC is not responsible for improper use of the different components.

MEC 18

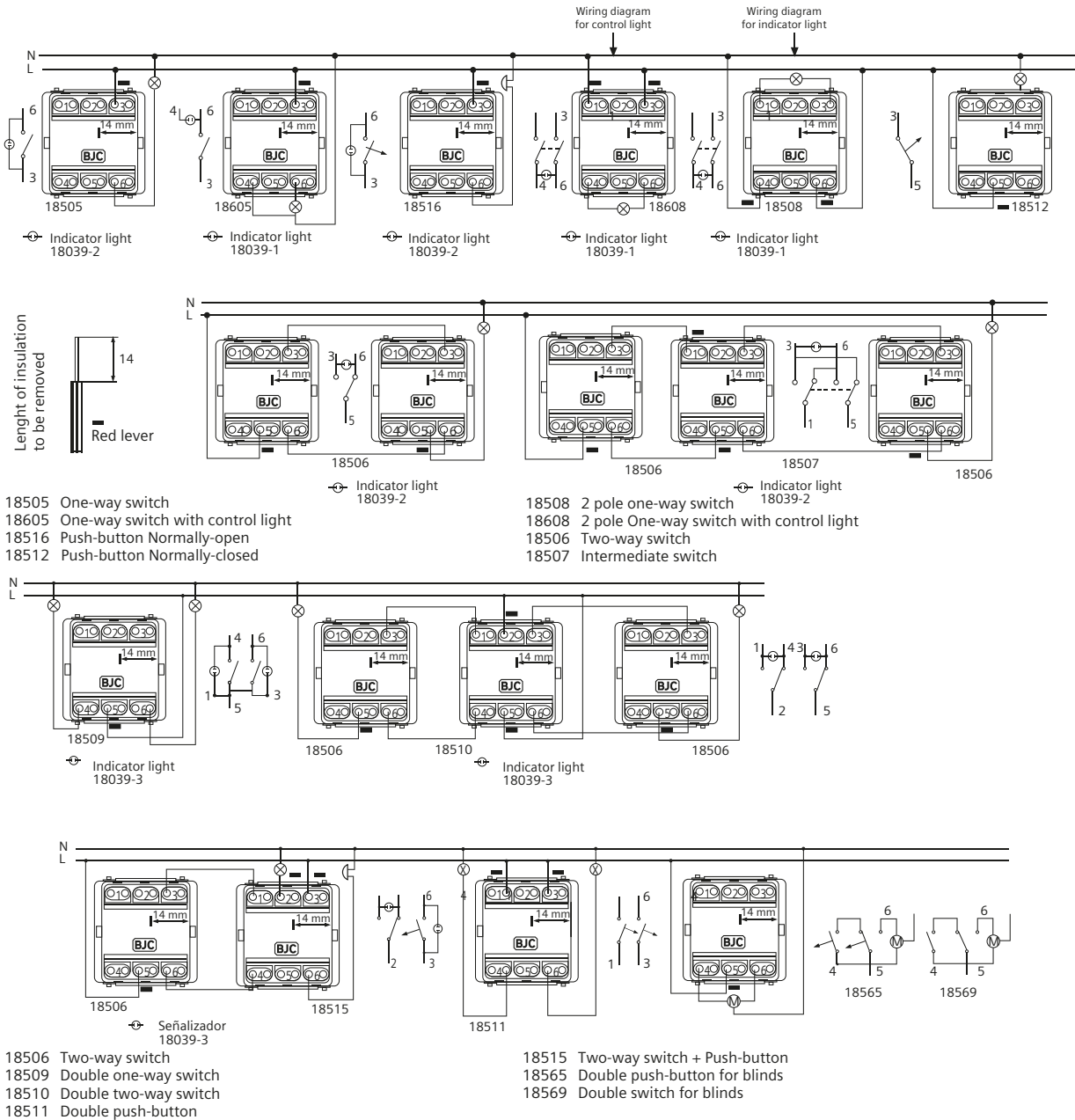

MEC 18 - LED loads table

References	Description	Rated power in W for SBL Loads
18505-X	ONE-WAY SWITCH	200W
18505	ONE-WAY SWITCH	200W
18605-X	ONE-WAY CONTROL SWITCH	200W
18605	ONE-WAY CONTROL SWITCH	200W
18506-X	TWO-WAY SWITCH	200W
18506	TWO-WAY SWITCH	200W
18506-LX	TWO-WAY SWITCH,	200W
18506-L	TWO-WAY SWITCH, WITH LIGHT	200W
18507-X	INTERMEDIATE SWITCH 10A	100W
18507	INTERMEDIATE SWITCH 10A	100W
18509-X	DOUBLE ONE-WAY SWITCH	200W
18509	DOUBLE ONE-WAY SWITCH	200W
18510-X	DOUBLE TWO-WAY SWITCH	200W
18510	DOUBLE TWO-WAY SWITCH	200W
18569-X	DOUBLE SWITCH FOR BLINDS 10A (INTERLOCKED)	100W
18569	DOUBLE SWITCH FOR BLINDS 10A (INTERLOCKED)	100W
18515-X	TWO WAY SWITCH & PUSH-BUTTON	200W
18515	TWO WAY SWITCH & PUSH-BUTTON	200W
18508-X	TWO-POLES SWITCH	200W
18508	TWO-POLES SWITCH	200W
18608-X	TWO-POLES CONTROL SWITCH	200W
18608	TWO-POLES CONTROL SWITCH	200W

Características técnicas



MEC 16



Length of insulation to be removed

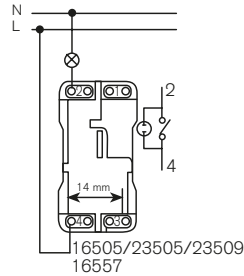

Indicator light
16039-2 (red)
21139-2 (white)

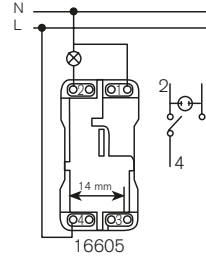

Indicator light
16039-1 (black)
21139-1 (blue)

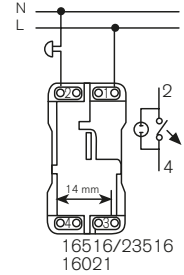

Indicator light
16039-2 (red)
21139-2 (white)

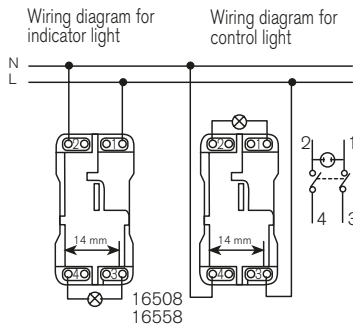

Indicator light
16039-1 (black)
21139-1 (blue)

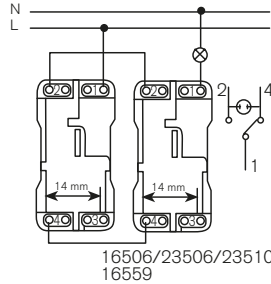

Indicator light
16039-2 (red)
21139-2 (white)

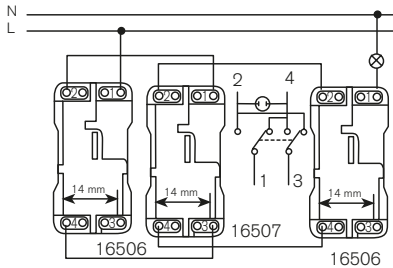

Indicator light
16039-2 (red)
21139-2 (white)

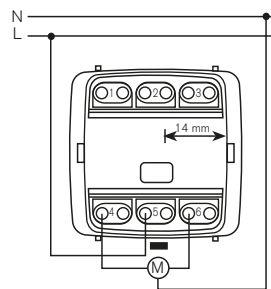

17665 Push-button for blinds
17669/23569 One-way switch for blinds

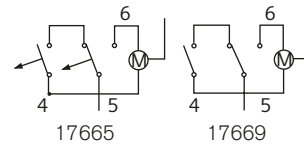

Red lever

- 16505/23505 One-way switch
- 16506/23506 Two-way switch
- 16507/23507 Intermediate switch
- 16508 2 pole one-way switch
- 16516/23516 Push-button
- 16021 Push-button
- 16605 One-way switch with control light

- 17665 Double Push-button for blinds
- 17669/23569 Switch for blinds
- 16557 One-way switch (16A)
- 16558 2 pole one-way switch (16A)
- 16559 Two-way switch (16A)

MEC 16 - LED loads table

References	Description	Rated power in W for SBL Loads
16505	ONE-WAY SWITCH	100W
16506	TWO-WAY SWITCH	100W
16507	INTERMEDIATE SWITCH	100W
2X16505	DOUBLE ONE-WAY SWITCH	100W
2X16506	DOUBLE TWO-WAY SWITCH	100W
17669	DOUBLE SWITCH FOR BLINDS (INTERLOCKED)	100W
16508	TWO-POLES SWITCH	100W
23505-YY	ONE-WAY SWITCH + METALLIC FRAME + ROCKER NEUTRAL	100W
23505-YYX	ONE-WAY SWITCH + METALLIC FRAME WITH CLAWS + ROCKER NEUTRAL	100W
23505-YYL	ONE-WAY SWITCH + METALLIC FRAME + ROCKER FOR PILOT LIGHT + LIGHT	100W
23505-YYLX	ONE-WAY SWITCH + METALLIC FRAME WITH CLAWS + ROCKER FOR PILOT LIGHT + LIGHT	100W
23506-YY	TWO-WAY SWITCH + METALLIC FRAME + ROCKER NEUTRAL	100W
23506-YYX	TWO-WAY SWITCH + METALLIC FRAME WITH CLAWS + ROCKER NEUTRAL	100W
23506-YYL	TWO-WAY SWITCH + METALLIC FRAME + ROCKER FOR PILOT LIGHT + LIGHT	100W
23506-YYLX	TWO-WAY SWITCH + METALLIC FRAME WITH CLAWS + ROCKER FOR PILOT LIGHT + LIGHT	100W
23507-YY	INTERMEDIATE SWITCH + METALLIC FRAME + ROCKER NEUTRAL	100W
23507-YYX	INTERMEDIATE SWITCH + METALLIC FRAME WITH CLAWS + ROCKER NEUTRAL	100W
23507-YYL	INTERMEDIATE SWITCH + METALLIC FRAME + ROCKER FOR PILOT LIGHT + LIGHT	100W
23507-YYLX	INTERMEDIATE SWITCH + METALLIC FRAME WITH CLAWS + ROCKER FOR PILOT LIGHT + LIGHT	100W
23605-YYL	ONE-WAY CONTROL SWITCH + METAL FRAME + ROCKER NEUTRAL + LIGHT	100W
23605-YYLX	ONE-WAY CONTROL SWITCH + METAL FRAME CLAWS + ROCKER NEUTRAL + LIGHT	100W
23508-YY	TWO-POLES SWITCH + METALLIC FRAME + ROCKER SYMBOL I/O	100W
23508-YYX	TWO-POLES SWITCH + METALLIC FRAME WITH CLAWS+ ROCKER SYMBOL I/O	100W
23508-YYL	TWO-POLES SWITCH + METALLIC FRAME + ROCKER SYMBOL I/O FOR PILOT LIGHT + LIGHT	100W
23508-YYLX	TWO-POLES SWITCH + METAL. FRAME CLAWS+ ROCKER SYMBOL I/O FOR PILOT LIGHT + LIGHT	100W
23509-YY	DOUBLE 1 WAY SWITCH + METALLIC FRAME + ROCKER DOUBLE	100W
23509-YYX	DOUBLE 1 WAY SWITCH + METALLIC FRAME WITH CLAWS + ROCKER DOUBLE	100W
23509-YYL	DOUBLE 1 WAY SWITCH + METALLIC FRAME + ROCKER DOUBLE FOR PILOT LIGHT + LIGHT	100W
23509-YYLX	DOUBLE 1 WAY SWITCH + METAL FRAME CLAWS + ROCKER DOUBLE FOR PILOT LIGHT + LIGHT	100W
23510-YY	DOUBLE 2 WAY SWITCH + METALLIC FRAME + ROCKER DOUBLE	100W
23510-YYX	DOUBLE 2 WAY SWITCH + METALLIC FRAME WITH CLAWS + ROCKER DOUBLE	100W
23510-YYL	DOUBLE 2 WAY SWITCH + METALLIC FRAME + ROCKER DOUBLE FOR PILOT LIGHT + LIGHT	100W
23510-YYLX	DOUBLE 2 WAY SWITCH + METAL FRAME CLAWS + ROCKER DOUBLE FOR PILOT LIGHT + LIGHT	100W
23569-YY	DOUBLE SWITCH FOR BLINDS + ROCKER DOUBLE SYMBOL "UP-DOWN"	100W
23569-YYX	DOUBLE SWITCH FOR BLINDS + ROCKER DOUBLE SYMBOL "UP-DOWN"	100W

Blinds centralization - Universal option

Blinds control modules with output by relay 5TC1271 and 5TC1270

They make it possible to centralize the blinds in a simple way, allowing the centralization elements to be placed in junction boxes.

These components must be used with electrically interlocked double push buttons.

These components do not temporize the raising or lowering of the blinds, so when the user needs to raise or lower the entire blind, the corresponding key on the push-button must be kept pressed until the action is completed.

For the central control it is recommended the use of some element that temporizes the rise or fall, such as:

- For Miro and Style: the blinds electronic switch 5TC1231 or the blinds temporized programmers. For instance the 5TC1520 from i-system.
- Standard DIN rail timers (one for up and one for down).

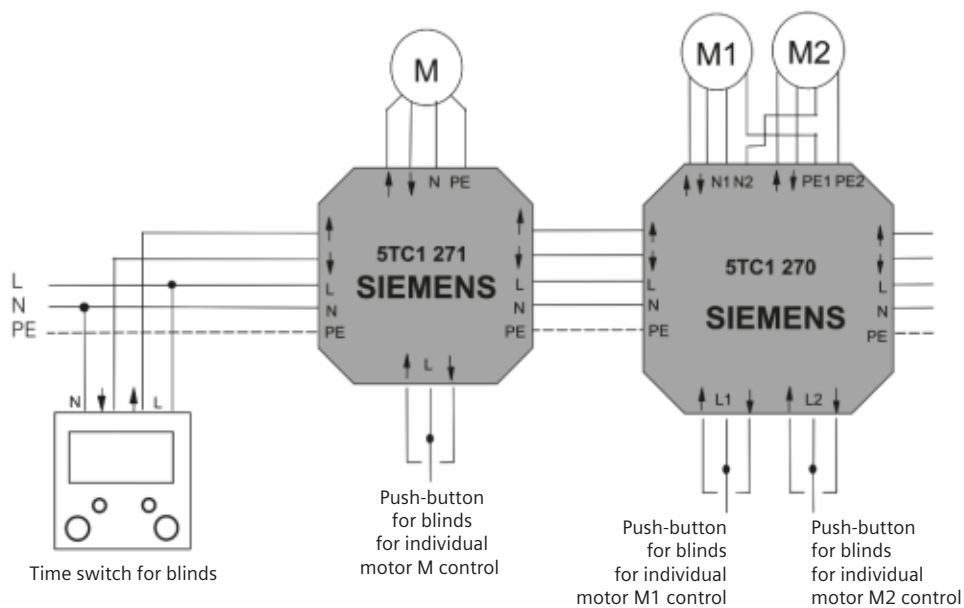

Blind controller

The 5TC1272 flush-mounted roller blind controller is used for local and/or central control of window roller blinds or other devices with single-phase 230VAC motors. Pressing the local control push-button once moves the roller blind in the chosen direction; pressing the other push-button stops the roller blind. Pressing the central control push-button moves the roller blind (lifting or lowering), regardless of its position and level.

Features:

- Used in the wired control systems of window roller blinds, sunblinds and gate drives (230VAC electric motors).
- Local and central control inputs.
- Easy to install on a junction box.
- Energy-saving device and constant opening mode available.
- Operation in the comfort mode – roller blind height level saved in the internal memory of the device (for example, halfway).
- Can be used in combination with any brand of push-buttons, which do not include indicator lights.

Installation and operation:

The controller performs the following operations: lifting, lowering or stopping the roller blind equipped in the one-phase 230VAC motor. Pressing the local control push-button once moves the roller blind in the chosen direction; pressing the other push-button stops the roller blind. Pressing the central control push-button moves the roller blind (lifting or lowering), regardless of its position and level.

Lifting comfort adjustments:

1. Press the local control push-button (LOCAL ▲).
2. When the roller blind is fully open, press the PROG push-button on the 5TC1272 casing.
3. The roller blinds are lowered automatically – press the PROG push-button again when set to the "comfort position".
4. Use the local control push-button (LOCAL ▲) to fully lift the roller blind (upper level fully open).
5. Hold down the local control push-button (LOCAL ▼) - the roller blind is lowered and stops at the "comfort position".

Lowering comfort adjustments:

1. Press the local control push-button (LOCAL ▼).
2. Press the PROG push-button when the roller blind is at the bottom (fully closed).
3. The roller blind is lifted automatically – press the PROG push-button again when it is in the "comfort position".
4. Use the local control push-button (LOCAL ▼) to fully lower the roller blind (lower level fully closed).
5. Hold down the local control push-button (LOCAL ▲) - the roller blind is lifted and stops exactly in the "comfort place".

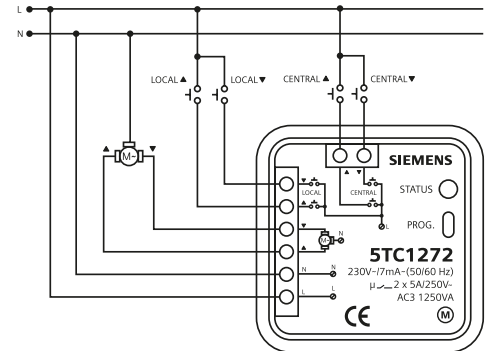

Iris / Coral

Cord operated inserts

18521 Cord operated push-button
18598 Cord operated two-way switch

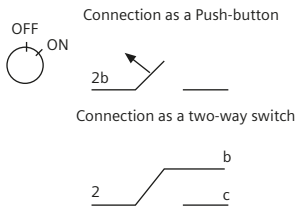

Key operated inserts

One-way / two-way switch with key

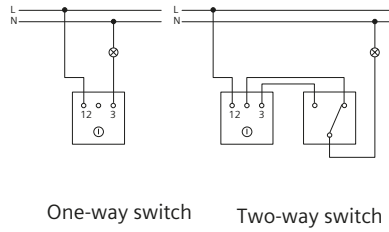

Timer switches codes 2382, 18599, 16599

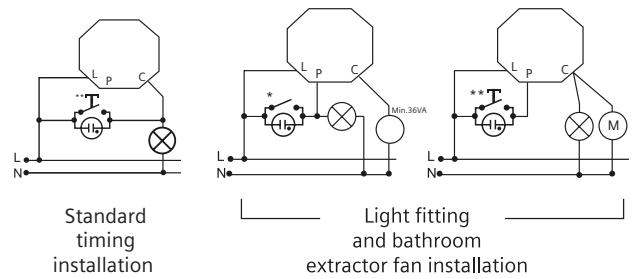

* = switch and **=push-button

Dimmers

21539-X/21549-X/23539-X/23549-X

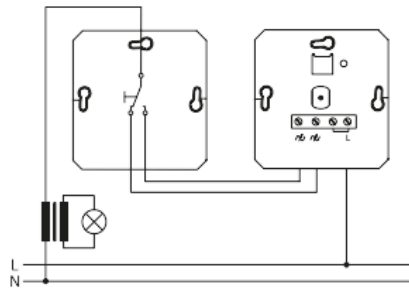
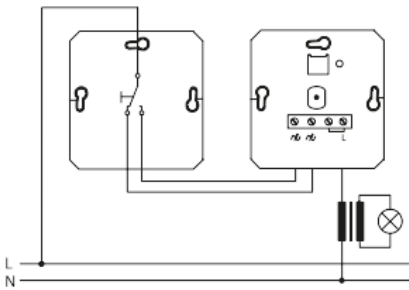

23543-X

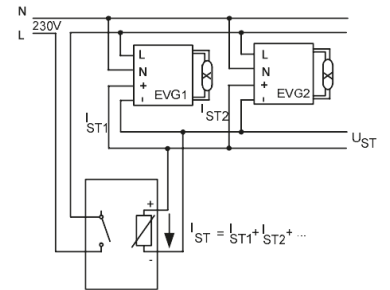

21542-X

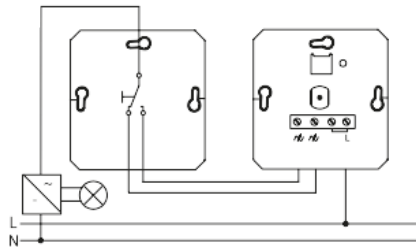
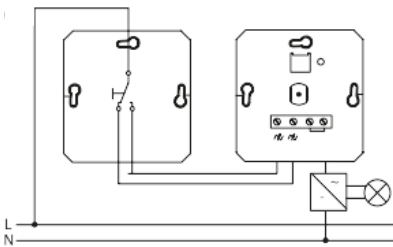

21547-X

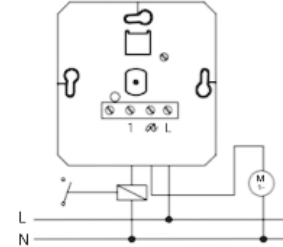

Schuko® with double USB charger

For a correct installation, it is recommended to install this product in an enclosure with a minimum free internal diameter of 54 mm (Without claws).

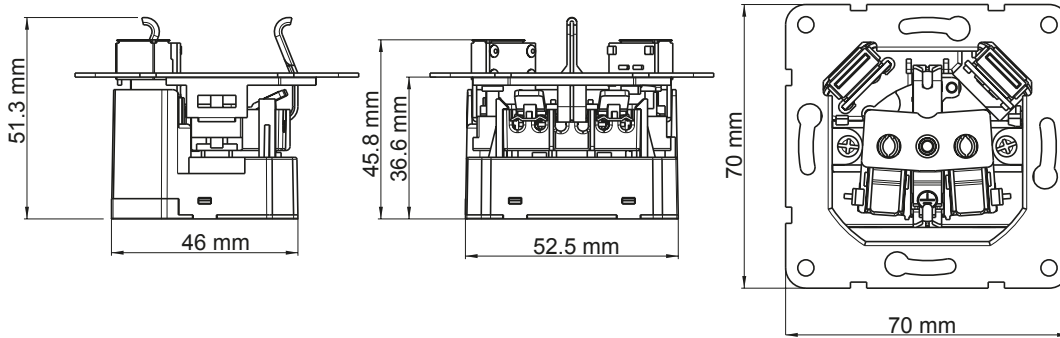

Technical data:

Schuko® socket

- 230 Vac 50Hz, 16A
- Screwless terminal

USB double charger

- 2 socket output USB Type A
- Input voltage: 100-250 VAC 50-60 Hz
- Consumption on standby: < 100mW complies with the ErP European Directive
- Short circuit protection
- Temperature protection

Standards and certificates: VDE 0620-1 / EN 62386-1

Emergency beacon light

Ref.: 18584

Technical information:

Power supply voltage: 230 V ~ $\pm 10\%$ 50 / 60 Hz

Lamp autonomy: 3 h ± 15

Battery recharge time: 12 h



Iris / Mega / Coral / Sun television socket outlets

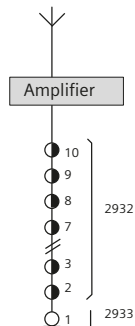

TV-FM socket outlets

MATV distribution system (Máster Antena Televisión)

Series installation

Floor	Code BJC	Code TELEVÉS	Type	Attenuation (dB)	
				Shunt	Step
2 to 10*	2932	5231	A-B	9,5	1,3
1	2933	5230	T	4,5	---

* If more than 10 socket outlets in a row are required, another series must be made from a distributor

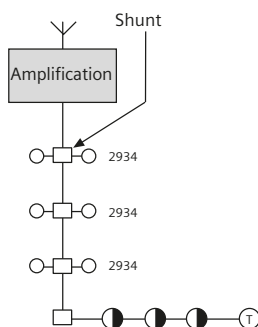

Shunt installation

Code BJC	Code TELEVÉS	Losses (dB)	
		TV	FM
2934	5232	0,5	3

The socket outlet 2934 can be replaced for Max. 4 socket outlets in a row

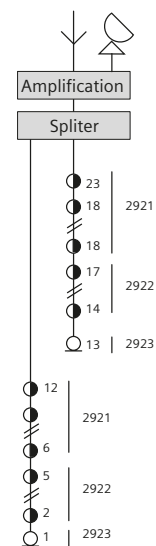

R/TV-SAT socket outlets

MATV distribution system (Máster Antena Televisión) and SMATV (Satélite Máster Antena TV)

Series installation

Floor	Code BJC	Code TELEVÉS	Type	Attenuation (dB)			
				Shunt		Step	
12 to 6*	2921	5236	B	20	20	0,6	0,8
5 to 2	2922	5227	A	13	14	1	1,2
1	2923	5229	T	4	5	---	---

* If more than 12 socket outlets in a row are required, another series must be made from a distributor

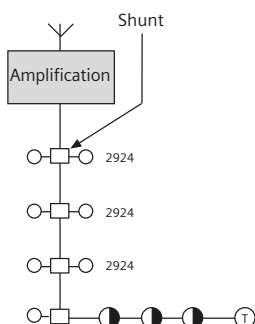

Shunt installation

Code BJC	Code TELEVÉS	Losses (dB)	
		TV	FM
2924	5226	0,6	1,5

The socket outlet 2934 can be replaced for Max. 5 socket outlets in a row

Iris / Mega / Coral television socket outlets

R/TV-SAT 3 salidas

R/TV-SAT, 3 outlets

MODEL	BJC	IKUSI
REFERENCE	2920	ARTU-S1 2720
Frequency bands	MHz	TV: 5-68 and 120-862 RD: 87-108 SAT: 950-2150
Connection attenuation (±0,5 dB)	TV inputs Input-RD Input-SAT	11,5 11,5 10
Max. step attenuation	5-68 and 120-862 MHz 87-108 MHz 950-2150 MHz	1 1 4
Output decoupling	TV outputs Output-RD Output-SAT	25 35 16
TV-RD and TV SAT decoupling		15
SAT-RD decoupling		25
Current flow per SAT output		YES

Serial installation

MODEL	BJC	IKUSI
REFERENCE	2920	ARTU-S0 2719
Frequency bands	MHz	TV: 5-68 and 120-862 RD: 87-108 SAT: 950-2150
Connection attenuation	TV inputs Input-RD Input-SAT	11,5 11,5 10
TV-RD and TV SAT decoupling		15
SAT-RD decoupling		25
Current flow per SAT output		YES

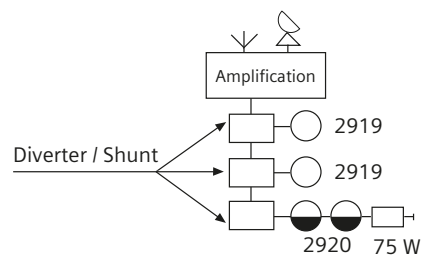

Iris / Mega / Coral Voice and Data connectors and adapters

Terminal	Conductor colour
2	Yellow
TX	Red
L2	White
L1	Brown
TS	Green
T	Blue

User jack for RJ11 telephony

(6 pins) screw-less terminal

Number of contact	Label colours	Designation and colours used in Spain	Analog Telephony	Digital Telephony
6	Green	T Blue		
5	Orange	T Green		
4	Blue/White	L1 Brown		
3	Blue	L2 White		
2	Orange/White	TX Red		
1	Green/White	2 Yellow		

Voice and Data connectors and adapters

Voice and Data connectors and adapters

(8 pins) screw-less terminal

N.º CONTACTS	EIA/TIA 568A	Diagram
8	Brown	Par 4
7	White/Brown	
6	Orange	Par 1
5	White/Blue	
4	Blue	
3	Orange/White	Par 2
2	Green	
1	White/Green	Par 3

N.º CONTACTS	EIA/TIA 568B	Diagram
8	Brown	Par 4
7	White/Brown	
6	Green	Par 1
5	White/Blue	
4	Blue	
3	White/Green	Par 2
2	Orange	
1	Orange/White	Par 3

Sound

Potentiometers

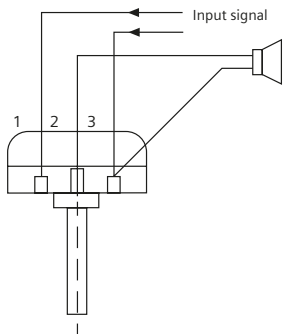

Mono sound wiring diagram
To change the volume direction (turn up/down) switch LINE IN from 1 to 3 or vice versa

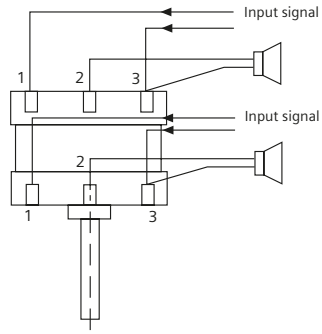

Stereo sound wiring diagram
To change the volume direction (turn up/down) switch LINE IN from 1 to 3 or vice versa

Audio channel

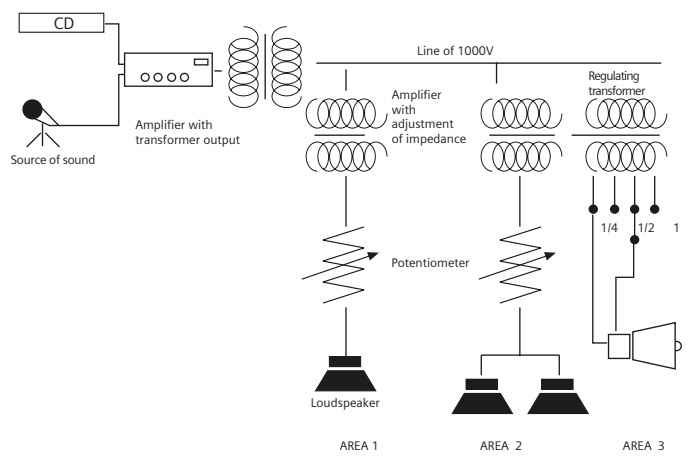

Schuko® with double USB charger

For a correct installation, it is recommended to install this product in an enclosure with a minimum free internal diameter of 54 mm (Without claws).

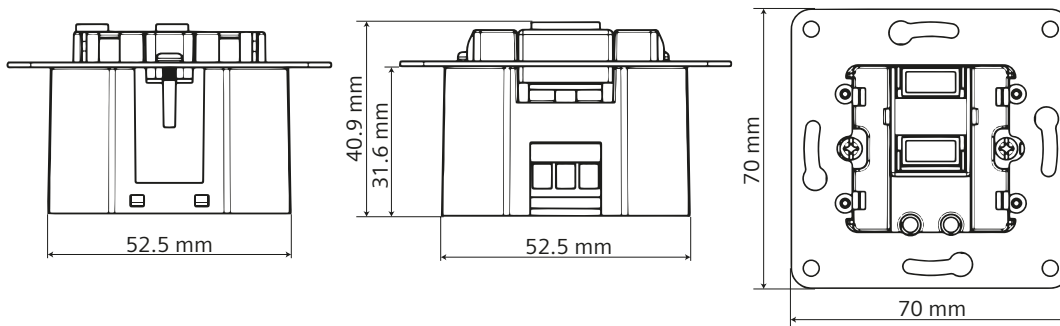

Technical data:

Schuko® socket

- 230 Vac 50Hz, 16A
- Screwless terminal

USB double charger

- 2 socket output USB Type A
- Input voltage: 100-250 VAC 50-60 Hz
- Consumption on standby: < 100mW complies with the ErP European Directive
- Short circuit protection
- Temperature protection

Standards and certificates: VDE 0620-1 / EN 62386-1

HDMI connector

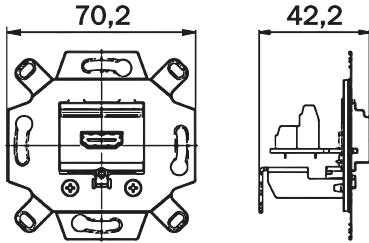

1. Strip about 45 mm of the outer sheath off. Push the braided wires back over the outer sheath. Remove the outer shielding foil until it is flush with the outer sheath.



2. Shorten each wire to a length of about 35 mm - except for the wire of the shielding!



3. Shorten the foil shield of the pairs of signal wires to about 10 mm, strip about 5 mm off each wire and tin the ends with solder (alternative: use 0.34 mm wire end sleeves).

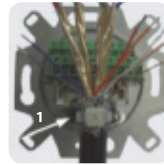

4. Fasten the cable to the holder (1) using a cable tie as a strain relief.



5. Connect the wires and shielding according to the labels.



Technical Specifications

There are currently five standards. Using numbers to designate the version (HDMI 1.0/1.1, etc.) is prohibited since November 2011. Devices are not permitted to display versions numbers any more either since January 1, 2012. The manufacturers are required to use descriptive logos.

- Category 1: 74,25 MHz (corresponding to the HDMI standard), can be used for Type A-Type A, C or D as well as Type C-Type C connector combinations.

- Category 2: 340 MHz (corresponding to the HDMI High Speed), can be used for Type A-Type A, C or D as well as Type C-Type C connector combinations.

All cables used should bear the "Approved HDMI®-Associate" logo as a seal of approval. It is more important for the installer to determine the type of application than designation (Category 1 or 2) so that the correct cable can be selected. The HDMI connector supports the HDMI standard and the HDMI High Speed standard with Type A connectors assuming the correct cable is used and has been properly installed.

Type	Terminal number	Terminal designation	PIN-no. norm	of Jack Rk	Example of color code for cable assignment (norm left, Rk right)	Description
plug  jack 	four high speed channels					
	1	2+	PIN 1		red/white-green	bundle 1, large gauge+shield wire
	2	2	PIN 2		shield wire (red/white (white/green)- bundle)	
	3	2-	PIN 3		white/green	
	4	1+	PIN 4		green/white-brown	
	5	1	PIN 5		shield wire (green/white (white/brown)-bundle)	bundle 2, large gauge+shield wire
	6	1-	PIN 6		white/brown	
	7	0+	PIN 7		blue/white-orange	bundle 3, large gauge+shield wire
	8	0	PIN 8		shield wire (blue/white (white/orange)-bundle)	
	9	0-	PIN 9		white/orange	
	11	CL+	PIN 10		brown/blue	bundle 4, large gauge+shield wire
	12	CL	PIN 11		shield wire (brown/white (blue/white)-bundle)	
	13	CL-	PIN 12		white/blue	other wires, small gauge
seven thin wires						
14	CEC	PIN 13		red/pink		
15	NC	PIN 14		white/free		
16	SCL	PIN 15		orange/green		
17	SDA	PIN 16		yellow		
18	⊥	PIN 17		grey/brown		
19	+5V	PIN 18		violet/white		
20	HPD	PIN 19		pink/grey		
10	⊥			shielding		

VGA connector

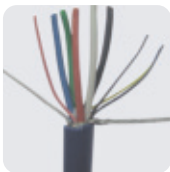
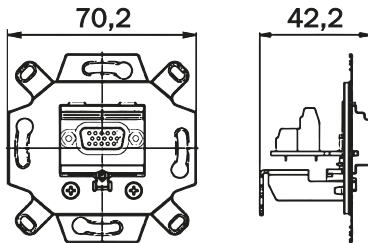

1. Strip about 45 mm of the outer sheath off twist the braided wires together.



2. Strip about 15 mm of insulation off the signal wires.



3. Twist the braided shields of the signal wires together strip about 5 mm off each wire and tin the ends with solder (alternative: use 0.34 mm wire end sleeves).

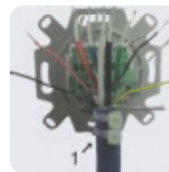

4. Fasten the cable to the holder (1) using a cable tie as a strain relief.



5. Connect the wires and shielding according to the labels. If necessary, use a solder terminal lug for the twisted shielding.

Technical Specifications

The VGA connector can be used in all standard systems and offers the following features:

- Graphic resolution of 1280x1024 pixels, Full HD with 1920x1080 pixels.
- Analog transmission using a 15-pin D-SUB connector.
- Maximum cable length of up to 30 m depending on the type of cable.

Type	Terminal number	Terminal designation	PIN-no. of the jack	Example of color code for cable assignment	Description
plug (from the front) 	11	R	PIN 1	red	
	12	G	PIN 2	green	
	13	B	PIN 3	blue	
	15	ID2	PIN 4		monitor ID 2
	6	DGND	PIN 5		digit. ground
	3	⊥	PIN 6	red	ground
	4	⊥	PIN 7	green	ground
	5	⊥	PIN 8	blue	ground
jack (from the front) 			PIN 9		not belegt
	1		PIN 10		synchronization ground
	2	⊥			
	7	ID0	PIN 11		monitor ID 0
	16	ID1	PIN 12		monitor ID 1
	10	HS	PIN 13		horizontal synchronization
	9	VS	PIN 14		vertical synchronization
	14	ID3	PIN 15		ID 3
8	↓			shielding	

USB connector

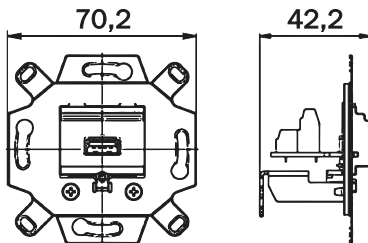

1. Strip about 20 mm of the outer sheath off.



2. Twist the braided wires together remove the foil shield.



3. Strip about 5 mm off each wire and tin the ends with solder (alternative: use 0.34 mm wire end sleeves).



4. Auflegenfasten the cable to the holder (1) using a cable tie as a strain relief connect the wires and shielding according to the labels.

Technical Specifications

USB is a serial bus that has replaced a number of legacy serial and parallel interfaces.

There are currently three USB standards. This USB port supports the USB 2.0 standard and can therefore be used with male USB 1.0/1.1 connectors with a Type A mating face.

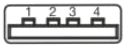
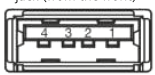
Type	Terminal number	Terminal designation	PIN-no. of the jack	Example of color code for cable assignment	Description
plug (from the front) 	5	5 V	PIN 1	red	VCC (+5V)
	4	D-	PIN 2	white	D- (Data-)
jack (from the front) 	3	D+	PIN 3	green	D+ (Data+)
	2	⊥	PIN 4	black	GND (ground)
	1	⊥	shielding		

Thermostats - For Iris / Mega and Coral series

Room thermostat

(Ref. 18544 and Ref. 21544)

Technical information:

Product: Thermostat for domestic use in heating and cooling applications

Power supply voltage: 230 V 50/60 Hz

Resistive cutting power (BT) 1900 W/230 V~ $\cos \varphi = 1$

Inductive cutting power (BT) 450 W/230 V~ $\cos \varphi = 0.6$

Cutting power (MBT) From 12 to 48 V 10 mA to 500 mA

Output Wiring: Changeover contacts to enable connection in heating or ventilation mode

Temperature for use: +0 °C to +40 °C

Temperature for storage: -5 °C to +60 °C

Setting range: +5°C to +30°C with stops to delimit a lower range of adjustment, between a minimum and a maximum. To ensure correct adjustment, always turn the button upwards to slightly exceed the desired value, before turning it back down and placing it at the desired point.

Before installing the front cover of this module, it is possible to set operating limits other than the +5 °C and +30 °C extremes set by default. This is done by positioning two toothed gears which act as a stop, preventing adjustment beyond the desired limits.

Notes: The regulation will not come into effect until a stabilisation period of 1-3 hours has passed, depending on the conditions of the installation. It is not valid for use in conditions other than those provided for in its assembly. It is recommended to mount these in individual boxes (since neighbouring elements could affect their operation) taking care to avoid installing them next to windows or doors, heat sources, fans or behind curtains or similar.

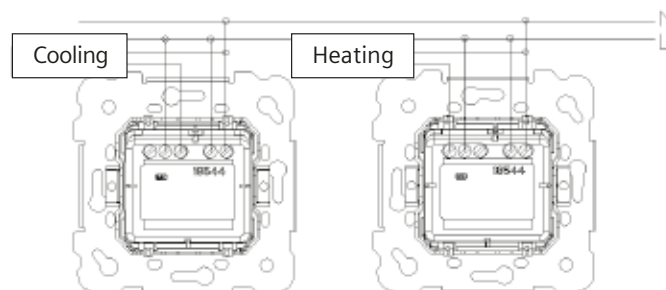

Thermostats - For Iris / Mega series

Room thermostat (Ref.: 18144)

Thermostat for indoor temperature control, for control of electric and hot water convectors, pumps and boilers. Supplied with manual switch, manual temperature regulation between 5 °C and 30 °C and connection for external night-time temperature reduction (5 °C).

Nominal characteristics:

Power supply 230 V~.

Cold contact:

- Resistive load max.: 5 A
 min.: 10 mA
 - Inductive Load (cos φ 0,6) max.: 2 A
 min.: 10 mA
 - Relative humidity max. 95% (without condensation).
- Do not install next to windows or doors or near heat sources, fans or behind curtains or similar.

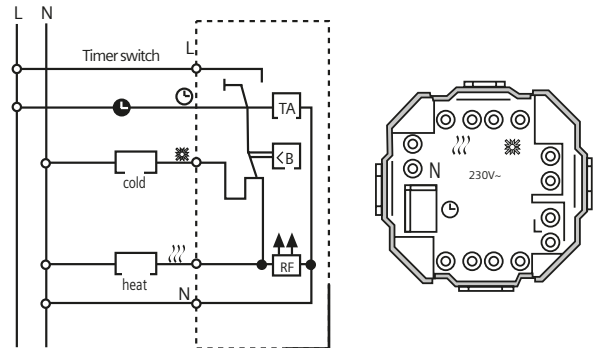

Heating contact:

- Resistive load max.: 10 A
 min.: 10 mA
- Inductive Load (cos φ 0,6) max.: 4 A
 min.: 10 mA

Floor heating thermostat Ref.: 18244

Code	Range
Floor temperature	*..5 (= 10..50 °C)
Red/green indicator light	Colour request / reduced consignment
Switch	On-off
Voltage	230 Vac (195...253 V) 50 Hz
Output	Relay
Permanent intensity	100 mA...16 A cos φ = 1; 100 mA...2 A cos φ = 0.6
Control algorithm	Proportional (similar to PWM)
Temperature differential	-1 °C
Remote probe	Length 4m, may be extended up to 50m
Consignment reduction	Adjustable, 3K or 5K
Range limiter	On the inside of the external wheel
Protection degree	IP30
Class	II.
Calculation of voltage impulse	2.5 kV
Compression test temperature	75 °C
Current and voltage for the measurement of interference	230 V, 16 A
Ambient temperature	0...40 °C
Storage temperature	-25...70 °C
Weight	90 g

IRIS/MEGA/CORAL/SOL

Chronothermostat

The 2381 is a chronothermostat for control of the room temperature. This chronothermostat is designed to switch on and off (depending on the time and ambient temperature) an electric appliance with a maximum consumption of 6 A, such as a circulation pump, a burner or a motorised mixing valve. It should only be used in dry rooms with a normal degree of pollution in domestic environments.

Connection examples

Control of a burner

Control via circulating pump or thermal accumulation / hot air heating

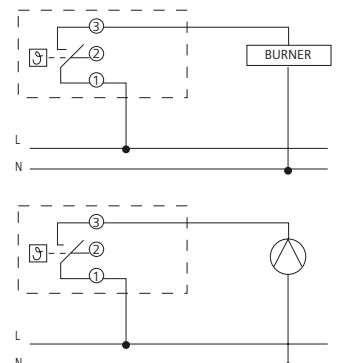

Motion detectors - For Iris / Mega / Coral / Viva series

Motion detector (Ref.: 18555)

Unlike other motion detectors that react only to moving heat sources, this detector will also be activated by sound. This means that it must initially be operated by movement, but after the lamp has been switched on it will not switch off when the movement ceases, as long as there is sound to be heard in the surroundings.

The sensitivity of this detector has been designed to detect the outline of the human body, logically including children. It will also react to some animals, mainly dogs of a certain size. This is inevitable, although in most cases it represents an advantage, since it chases away unwanted animals. As long as there is movement, the connected lamps will remain on. When the movement stops, they will automatically turn off at the predetermined time.

After a mandatory 3-second reset delay, the detector is ready to be activated again.

Technical information

Power supply voltage: 230 Vac +6%/-10%

Detection angle: 180° horizontal / 60° vertical

2-wire connection, triac output

Maximum load: 40-300 Max. Incandescent/Halogen

- Range (1.2-2.2 m mounting height), maximum 8 m for lateral movement, approx. 3 m for frontal movement.
- Timing from 4s to 10 min
- Twilight level of 5 to 1000 lux
- Dimensions: LxA 87x87 mm / Depth 36 mm
- Protection degree: IP20, II
- Housing material: ABS

Replacement of an existing single pole one-way switch

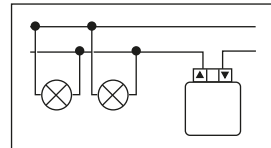

2 detectors may be placed in parallel (only 2, as a maximum) in the same room

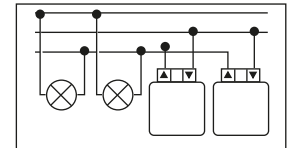

Operates as a staircase timer in combination with pushbuttons (open at rest)

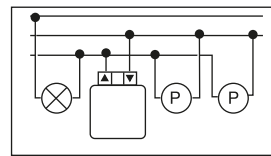

Operates as a staircase timer in combination with pushbuttons (closed at rest)

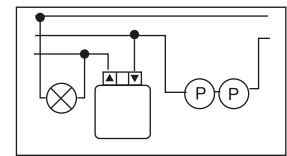

18555-3/23555-3

(3 wire, relay output)

- Resistive load 2300 W, 10 A max., cos φ : 1
- Inductive load 1150 VA, 5 A max., cos φ : 0,5
- Halogen lamps with 1000 VA transformer
- Electronic ballasts, for example 25x36 W (140 F max.)

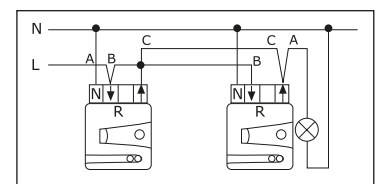
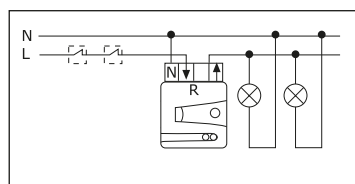
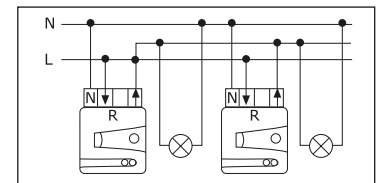
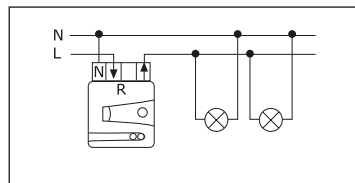

Industrial Material - Industrial Cetact socket outlets & plugs

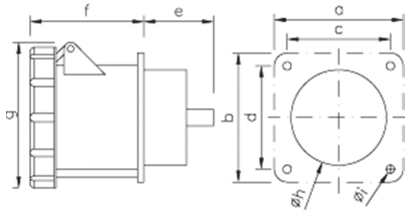

IP67 Panel-mounted socket outlets, straight

Reference	CT-9954	CT-9955
Amps	125	125
Poles	3P+E	3P+N+E
axb	120	120
cxd	100	100
e	68	68
f	90	90
g	126	126
h	68	68
i	7	7

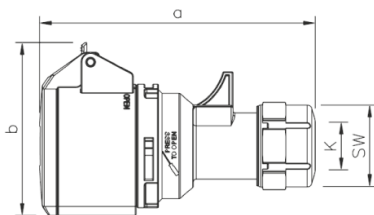

IP44 Connectors

Reference	CT-71213	CT-71214	CT-71215	CT-71223	CT-71224	CT-71225
Amps	16	16	16	32	32	32
Poles	2P+E	3P+E	3P+N+E	2P+E	3P+E	3P+N+E
a	129	135	142	159	159	165
b	76	80	89	92	92	98
k	6-15	6-15	8-16	10-20	10-20	12-22
sw	38	38	42	50	50	50

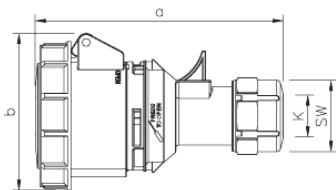

IP67 Connectors

Reference	CT-73303	CT-73413	CT-73423	CT-73306	CT-73416	CT-73426
Amps	16	16	16	32	32	32
Poles	2P+E	3P+E	3P+N+E	2P+E	3P+E	3P+N+E
a	133	139	145	162	162	168
b	78	84	92	96	96	102
k	6-15	6-15	8-16	10-20	10-20	12-22
sw	38	38	42	50	50	50

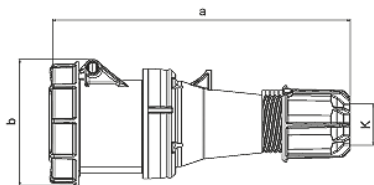

IP67 Connectors

Reference	CT-9950	CT-9951
Amps	63	63
Poles	3P+E	3P+N+E
a	269	269
b	114	114
k	36	36

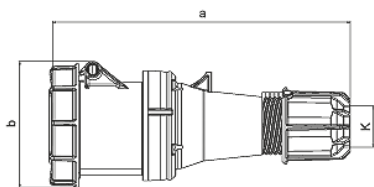

IP67 Connectors

Reference	CT-9956	CT-9957
Amps	125	125
Poles	3P+E	3P+N+E
a	287	287
b	124	124
k	50	50

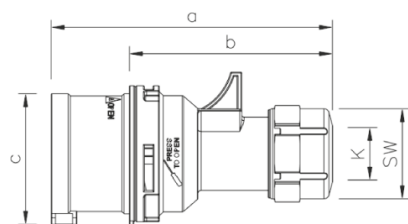

IP44 plugs

Reference	CT-71013	CT-71014	CT-71015	CT-71023	CT-71024	CT-71025
Amps	16	16	16	32	32	32
Poles	2P+E	3P+E	3P+N+E	2P+E	3P+E	3P+N+E
a	118	124	131	146	146	152
b	82	88	95	100	100	106
c	47	53	61	63	63	70
k	6-15	6-15	8-16	10-20	10-20	12-22
sw	38	38	42	50	50	50

Industrial Material - Industrial Cetact socket outlets & plugs

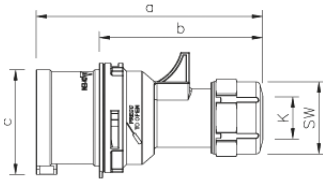

IP67 plugs

Reference	CT-77303	CT-77413	CT-77423	CT-77306	CT-77416	CT-77426
Amps	16	16	16	32	32	32
Poles	2P+E	3P+E	3P+N+E	2P+E	3P+E	3P+N+E
a	118	124	132	146	146	152
b	71	79	87	93	93	100
k	6-15	6-15	8-16	10-20	10-20	12-22
sw	38	38	42	50	50	50

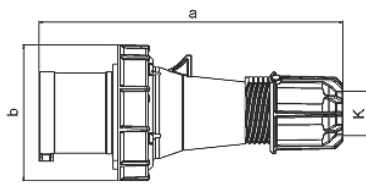

IP67 plugs

Reference	CT-9952	CT-9953
Amps	63	63
Poles	3P+E	3P+N+E
a	257	257
b	114	114
k	36	36

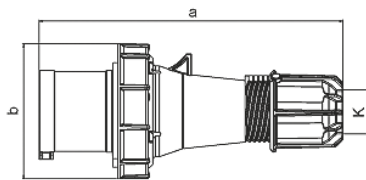

IP67 plugs

Reference	CT-9958	CT-9959
Amps	125	125
Poles	3P+E	3P+N+E
a	270	270
b	131	131
k	50	50

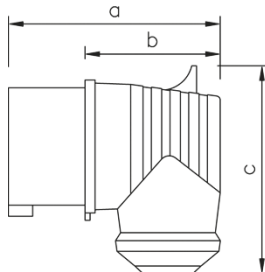

IP44 Angle plugs

Reference	CT-75302	CT-75412	CT-75422
Amps	16	16	16
Poles	2P+E	3P+E	3P+N+E
a	104	108	101
b	67	72	65
c	78	92	98

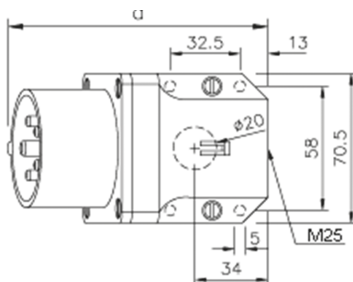

IP44 Wall-mounted inlets

Reference	CT-9979	CT-9962	CT-9980	CT-9990
Amps	16	32	32	32
Poles	3P+E	2P+E	3P+E	3P+N+E
a	121	131	131	132
b	76	83	83	85

b=Höhe
Neigung=15°

Industrial Material - Industrial Contact socket outlets & plugs

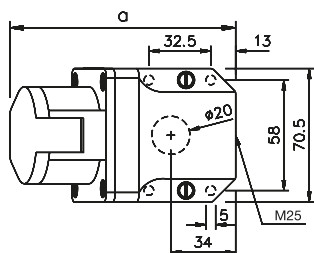

INDUSTRIAL PLUGS AND SOCKET OUTLETS FOR EXTRA-LOW VOLTAGE

IP44 Extra-low voltage wall-mounted socket outlet

Reference **I-162**

Amps 16

Poles 2

a 119

b 84,5

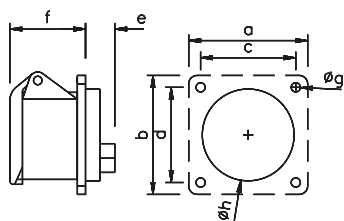

IP44 Extra-low voltage panel-mounted socket outlet, straight

Reference **I-362**

Amps 16

Poles 2

axb 70

cx d 56

e 19

f 40

g 5,5

h 43

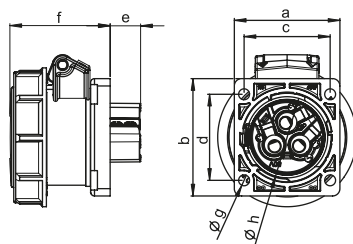

IP67 Extra-low voltage panel-mounted socket outlet, straight

Reference **I-3622**

Amps 16

Poles 2

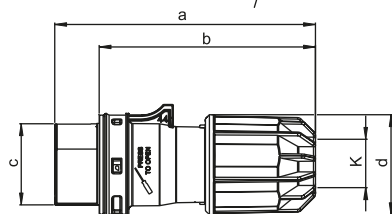

IP44 Extra-Low voltage plug

Reference **I-062**

Amps 16

Poles 2

a 132

b 110

c 41

d 51

k 8-24

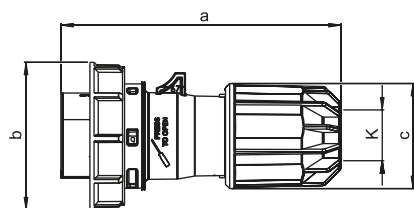

IP67 Extra-low voltage plug

Reference **I-0622**

Amps 16

Poles 2

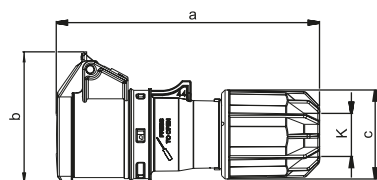

IP44 Extra-low voltage connector

Reference **I-262**

Amps 16

Poles 2

a 150

b 75

c 51

k 25

Industrial Material - TCP boxes

Polycarbonate • Colour Grey RAL 7035 • IP55-Protection degree (UNE 20324), IK08 (UNE-EN 50102) in a vertical position

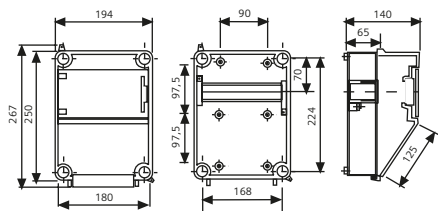

T-13

TCP box with capacity for 8
17.5 mm modules

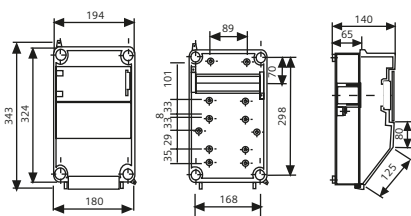

T-15

TCP box with capacity for 8
17.5 mm modules

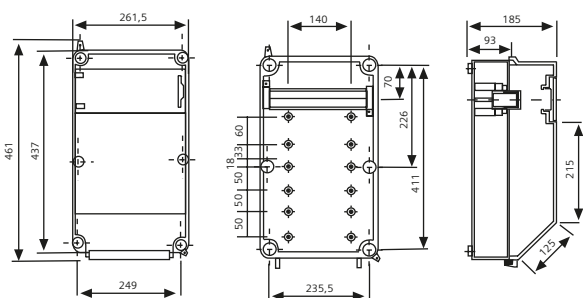

T-17

TCP box with capacity for 12
17.5 mm modules

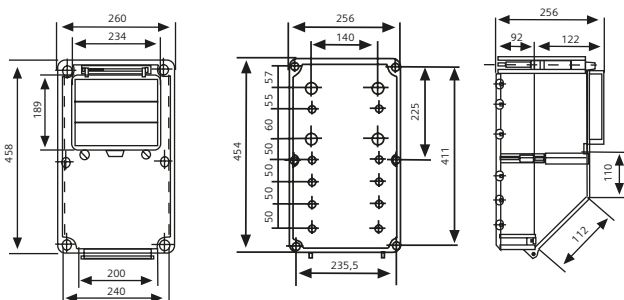

T-16 (IP54)

TCP box with capacity for 24
17.5 mm modules

Industrial Material - Watertight surface-mounting junction boxes

MARINER SERIES

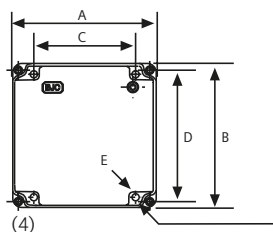

	A	B	C	D	E
I-6201	93,5	93,5	53,5	77,5	5,5 (2)
I-6202	113,5	113,5	73,5	97,5	5,5 (2)
I-6203	135	135	95	115	5,5 (4)
I-6204	155	155	115	135	5,5 (4)
I-6205	182	242	125	214	6 (4)
I-6207	182	242	125	214	6 (4)

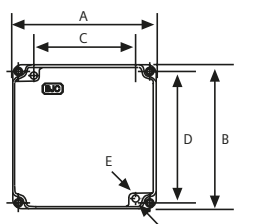

(2)

ALUMINIUM SERIES

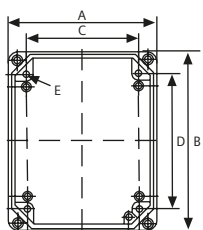

	A	B	C	D	E
4063	174	214	130	156	Ø7
4064	214	264	170	206	Ø7
4065	174	214	130	156	Ø7
4066	214	264	170	206	Ø7

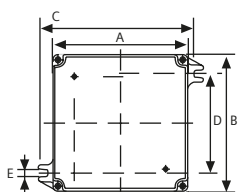

	A	B	C	D	E
4022	94	94	108	64	Ø6
4032	114	114	128	84	Ø6
4042	136	136	150	98	Ø6
4052	156	156	170	118	Ø6
4053	156	156	170	118	Ø6
4020	94	94	108	64	Ø6
4030	114	114	128	84	Ø6
4040	136	136	150	98	Ø6
4050	156	156	170	118	Ø6

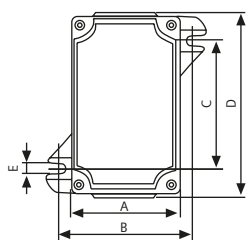

	A	B	C	D	E
4000	60	70	67	98	Ø6
4002	114	128	84	114	Ø6
4021	94	108	64	94	Ø6
4031	114	128	84	114	Ø6



A company of the Siemens group BJC

Fábrica Electrotécnica Josa, SAU

Av. de la Llana, 95-105
08191 RUBÍ (Barcelona)
España / Spain

ORDER PROCESSING &
SALES MANAGEMENT

0034 93 561 05 06
export@bjc.es

www.bjc.es/en